

# SSInverter V/F & Vectore **SSI80**



**User Manual-EN**

# SSInverter New Drive SSI80



## Preface

Thanks for choosing the SSI80 Vector frequency converter.

Before using the products, please read the manual first to make sure the performance and specification of the products are fully understood, so that the products can be installed and operated safely and achieve the best value for the customer. Specifically, the manual describes the demands for maintenance and reconditioning of the products, please read the manual or download relevant materials from our website when needed.

Only professional electrical engineer is allowed to install or debug the product wherever high voltage is applied. In the manual, some information is marked with ⚠ (Caution) or ⚡ ( Danger) to warn of the safety demands for moving, installing, operating and testing the products. Please follow the demands. If any question, please contact us for professional advices.

To fulfil more and more demands from the customer, we may upgrade our products and the manual as well, you may not receive the notification if no special agreement is made. Please keep attention to our website or consult us if any change happens

# Contents

<b>CHAPTER 1 SSI80 MODEL AND SPECIFICATION</b> .....	<b>1</b>
1.1 NAMEPLATE OF SSI80.....	1
1.2 MODELS FOR SSI80 .....	1
1.3 SPECIFICATION.....	2
1.4 DERATING REQUIREMENT .....	2
1.5 SSI80 KEYPAD.....	3
1.5.1 SSI80 Keypad: .....	3
1.5.2 Main specification and model of keypad.....	3
1.6 OTHER OPTIONS SUPPORTED IN SSI80.....	3
<b>CHAPTER 2 OPERATION INSTRUCTION FOR SSI80</b> .....	<b>4</b>
2.1 SAFETY INSTRUCTION OF SSI80.....	4
2.1.1 Before Power On.....	4
2.1.2 With Power on.....	5
2.1.3 Running .....	5
2.1.4 Power Off.....	5
2.2 MECHANICAL AND ELECTRICAL INSTALLATION .....	5
2.2.1 Mechanical Installation .....	5
2.2 MECHANICAL AND ELECTRICAL INSTALLATION .....	5
2.2.1 Installation Environment .....	5
2.2.2 Outline and Installation Dimensions .....	6
2.2.3 Product Installation.....	6
2.2.4 Auxiliary Components Installation.....	7
2.3 SSI80 ELECTRICAL INSTRUCTIONS .....	11
2.3.1 Electrical Diagram.....	11
2.3.2 SSI80 Terminals.....	12
2.3.4.1 EMC Standards.....	14
<b>CHAPTER 3 PARAMETERS</b> .....	<b>16</b>
3.1 LIST OF PARAMETERS.....	16
3.2 DETAILED DESCRIPTION FOR PARAMETERS .....	25
3.2.1 Parameter Group 0: General Control Mode and Commands.....	25
3.2.2 Group 1 Basics for Inverter and Motor Control .....	30
3.2.3 Parameter Group 2: Digital Terminal Functions .....	35
3.2.4 Parameter Group 3: Analogue Terminal Functions.....	39
3.2.5 Parameter Group 4: Process PID and Other Controllers .....	42
3.2.6 Parameter Group 5: Limitation, Protection and Failure Detection .....	44
3.2.7 Parameter Group 6: Keypad Operation and Display .....	48
3.2.8 Parameter Group 7: Auxiliary and Special Functions .....	48
3.2.9 Parameter Group 8: Basic and Running Information .....	50
3.2.10 Parameter Group 9: Real Time Running Status Monitoring .....	51
3.2.11 Parameter Group 19: Simple PLC .....	52
3.2.12 Parameter Group 20: Pump application.....	53
<b>CHAPTER 4</b> .....	<b>55</b>
4.1 INTRODUCTION OF THE KEYS: .....	55
4.2 SETTING OF THE PARAMETERS .....	55
4.3 Monitor the Product Status.....	56
4.4 Check the Fault Log (Warning or Alarm Log).....	56
4.5 Comparison Table for Character Displaying.....	57
<b>CHAPTER 5</b> .....	<b>58</b>
5.1 FAULT HANDLING.....	58
5.1.1 Fault codes and Handling.....	58
5.1.2 How to Get the Fault Info.....	60
5.2 MAINTENANCE.....	60
5.2.1 Routine Inspection.....	60
5.2.2 Maintenance .....	60
5.2.3 The storage and transportation of product.....	61
5.2.4 Scrapping of the product .....	61
<b>CHAPTER 6 SSI80 BASIC APPLICATION GUIDE</b> .....	<b>62</b>
6.1 CONTROL WITH KEYPAD.....	62
6.2 CONTROL WITH TERMINALS.....	62
6.3 RESET THE PARAMETERS TO FACTORY DEFAULTS .....	62
6.4 RESET THE FAULTS (ALARMS).....	62
6.5 MOTOR PARAMETERS AUTO TUNING.....	63

# Chapter 1 SSI80 Model and Specification

## 1.1 Nameplate of SSI80

Nameplate for SSI80

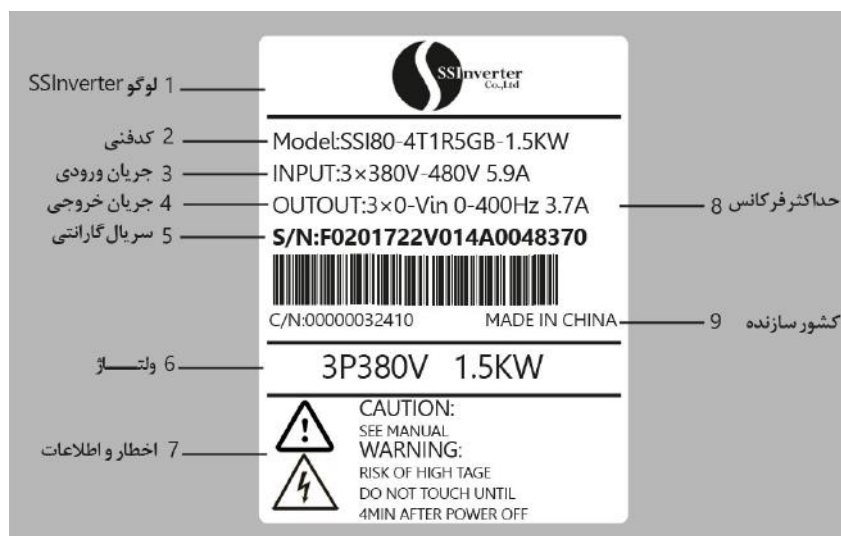

Item	Description
1	Logo
2	Type code
3	Power input specification
4	Power output specification
5	Order number
6	Voltage
7	Warning information
8	Maximum frequency
9	Company name

Explanation of the Type Code:

No	Model:AD80-4T1D5	
1-4	SSI80	SSI80 Series
5-6	4T	Line in voltage, 4T: 3phase380V 2T: 3phase220V 2S: single phase 220V
7-15	1R5	Power size, 1R5 means 1.5kw

Note: (“/” and “-” are not counted in the number of digits)

## 1.2 Models for SSI80

Model Type	Power (kW)	Voltage (V)	Current		Air(m³/h)
			Input (A)	Output (A)	
SSI80-2S0R4	0.37	1×200-240	6.2	2.2	17.2
SSI80-2S0R7	0.75	1×200-240	9	4.2	17.2
SSI80-2S1R5	1.5	1×200-240	15	6.8	17.2
SSI80-2S2R2	2.2	1×200-240	22.5	9.2	17.2
SSI80-4T0R7	0.75/1.5	3×380-440	3.6	2.2	17.2
		3×440-480	3.1	2.0	
SSI80-4T1R5	1.5/2.2	3×380-440	5.9	3.7	17.2
		3×440-480	5.1	3.4	
SSI80-4T2R2	2.2/4.0	3×380-440	8.3	5.1	17.2
		3×440-480	7.3	4.8	
SSI80-4T4R0	4.0/5.5	3×380-440	14.6	9.2	45.5
		3×440-480	12.6	8.4	
SSI80-4T5R5	5.5/7.5	3×380-440	19.2	12.0	90
		3×440-480	18.0	10.9	
SSI80-4T7R5	7.5/11	3×380-440	24.7	15.5	90
		3×440-480	21.4	14.2	

## 1.3 Specification

Items		Specification
Line in	Voltage	Single Phase 200~240V -15%~+10%; Three Phase 380~480V -15%~+10%;
	Frequency	50/60Hz±5%
	Unbalance	3%;
Out put	Voltage	3 Phase 0~100% Line in voltage;
	Frequency	0~400Hz;
Main Control	Control algorithm	V/F, Vector Control;
	Motor Type	Induction Motor
	Start Torque	0.5Hz 150%;
	Overload	Heavy load type: 150% 60s, 180% 3s;
	Switching Frequency	0.37~22Kw: 2k~16kHz;
	Speed resolution	Digital: 0.001Hz; Analogue: 0.5‰ of the maximal setup;
	Speed accuracy at Speed Open Loop	±0.5% of Nominal speed
	Source of Control Command	Keypad, DI inputs, Bus communication
	Source of Reference	Keypad, Analogue inputs, Bus communication
	Acieration/Deceleration setup	4 sets of acceleration/deceleration time, range: 0.05-6000.00s;
Basic Functions	Speed open loop, Process close loop, Motor auto tuning, Load compensation, auto DC voltage regulation, DC brake/AC brake, speed limit, current/torque limit, fly start, KEB etc.	
Application Functions	Multistage speed control by terminals or PLC function, S ramp, Mechanic brake, counter, Process PID, Jog etc.	
Protection Functions	Short circuit, Ground fault, line phase loss, under voltage, over voltage, over current, overload, over temperature, motor thermal protection, motor phase loss, control wire broken etc.	
Control Terminals	DI	5(select PNP or NPN mode due to jumper )
	AI	2
	AO	1 (select voltage output or current output due to jumper)
	RL	1, STDP
	RS485	1 RS485(select terminal resister due to jumper)
	Output Supply	24V/50mA
	10V	10V/10mA
	Keypad	Pluggable
	Connector	RJ45
Operation Environment	Protection Level	IP20;
	Operation Ambient Temperature	Operating range : -10°C ~ 45°C Nminal current to 40°C, derate from 40°C
	Operation Ambient Humidity	5%-85% (No condensing at 95%);
	Vibration	1.14g;
	Altitude	1000m, derate from 1000m
	Motor cable length	Shielded Cable: 50m; Un-shielded cable:100m
Others	Brake Chopper	Built in

## 1.4 Derating requirement

Derating with temperature: when used as heavy load type, derating is required from temperature higher than 40°C. 2.0% per degree is demanded. when used as heavy load type, derating is required from temperature higher than 40°C. 3.0% per degree is demanded.

Derating with altitude: derating is required from altitude higher than 1000m. 1% load per 100m or 0.5°C ambient ambient temperature is demanded.

## 1.5 SSI80 Keypad

SSI80 support pluggable keypad KP00 with LED display.



### 1.5.1 SSI80 Keypad:

Item	Description
1	Model
2	Sales number(F0100001)+SW version(V002) + Production site(A) + SN(0001) + week-year(518)
3	Bar code
4	QC Pass
5	Certification logo: RoHS CE UL WEEE ed.

Explanation of the type code:

Model:AD-KP00		
1-2	SSI	Used for SSInverter drives
3-6	KP00	Type of the keypad

### 1.5.2 Main specification and model of keypad

Model Type		KP00
Main specification	Display	Five LEDs display with 8 segments
	Remoting distance	5m
	Additional Interface	NO
	Real Time Clock	NO
Appearance		

## 1.6 Other options supported in SSI80

Options for din-rail mounting, decoupling plate can be afforded for SSI80 application. Din-rail mounting option is only for products below 4KW. Decoupling plates are available only for products below 7.5Kw.

In additional, based on the application demands, external chokes, brake resistor or filters could be necessary. The selection of these parts is recommended in this manual. You can buy from a third party, or ask for from us.

# Chapter 2 Operation Instruction for SSI80

## 2.1 Safety Instruction of SSI80

Definition of Safety:

In the manual, the do's and don'ts of safety announcements are classified into two categories as below:

 **Caution:** Not following the safety announcements may lead to damage of the product or equipment

 **Warning:** Not following the safety announcements may lead to death or hurt to the humane body

### 2.1.1 Before Power On

 **Caution**

The power supply must be within the specification of product.

Please install the product in a safe environment. Please operate the product within the specified ambient temperature and humidity, avoid direct sunlight to the product. Please prevent the product from dripping water because the protection level of product is IP20. Installing the product in an unsafe environment may lead to fire, explosion or electric shock.

If the product is installed in a cabinet, please ensure a good air conduct. Cooling fans to take the heat out of the cabinet is demanded especially when there are some other components that generates heat. The ambient temperature inside the cabinet should be controlled within specification of all the parts to avoid over temperature protection or fire.

You should NOT RUN/STOP the product by switching on/off the input power to the product, e.g. with a contactor. This operation may lead to damage of the product. Keypad, IO terminal or bus communication command is recommended to run/stop the product.

Installing contactor or air switch at the output side of the product is not recommended. If you have to do so, please make sure that the output current of the product is stopped when operating the contactor or switch.

It is prohibited to connect any capacitor or varistor directly at the output side of the product. Doing so may lead to unexpected failure of damage of the product.

High distortion over the standards in the power supply, including harmonics and unbalance, may lead to failure or damage of the product. Please avoid connecting to the common-connection-point directly with equipment which generate strong distortion in the grid, e.g. electric welding machine.

Make sure all the power ports (R/S/T/+/-BR/U/V/W) are connected correctly, otherwise the product will be damaged when power on or start.

In factory default set up, motor thermal protection is disabled. If this function is demanded, please set the parameter according to the manual.

Isolation tests to the product or internal components could be destructive and damage the product. Please consult us if you need to do so.

Electronic components is sensitive to ESD, do not touch the PCBAs without ESD protection.

The product is designed for high voltage operation, only qualified electrical engineers can be responsible for the installation, commissioning, tests and maintenance for the product.

Do NOT move the product via the front cover of the product to avoid dropping hazard. Please use the bottom of the product or the specifically designed construction.

 **Warning**

Make sure the power is off for enough time before connecting the wires

Please install the product on fire-proof material to avoid any fire hazard.

Do not install the product in the environment with explosive gases, otherwise there will be explosion hazard.

Connect the PE terminal to the safe ground. NEVER use the null line as ground, otherwise it may lead to electric shock.

It is strictly prohibited to disassemble the products and change the parts, components, connections or setup of the products without permission. Doing so may lead to electric shock, explosion etc.

Please install the product cover correctly before power on.

### 2.1.2 With Power on



#### Warning

NEVER plug or remove any part of the product when the product is powered except for the detachable keypad. Doing so may lead to product damage or humane injury or death.

Keep children and irrelevant person away from the product when it is powered on.

### 2.1.3 Running



#### Caution

Do Not switch in/off the motor to the product during running. Doing so may lead to failure or damage of the product.

Motor cable length exceeding the specification will reduce the life time of the products or lead to failure. If multi-motor is connected to the product, the total motor cable length should be within 50% of the specification. If motor cable length exceeds the limitation, please install filter at the output of the product.

Pay attention to the speed limitation for the motor bearing and other mechanical device.



#### Warning

Do NOT touch or detect the circuit with detector of multimeter, oscilloscope or any other equipment.

Do NOT open the front cover of the product during running.

If the Fault-Auto-Restart function is enabled by parameter setup, the motor may rotate again after failure. Please stay away from any moving part including the motor.

### 2.1.4 Power Off



#### Warning

Before touch the power terminals or any part inside the product, please make sure all the connections which can power the product have been removed, including AC line in, DC inputs.

Even all the connections which can power the product have be removed, there could still be residual voltage inside. Please wait for enough time according to the specification before touch the power terminals or any internal parts.

## 2.2 Mechanical and Electrical Installation

### 2.2.1 Mechanical Installation

#### 2.2.1.1 Installation Environment

The operation ambient temperature should be within -10°C~60°C;

Install the product on fire-proof material;

Installation vibration should be not higher than 1.14g. Make sure the product is fixed properly to the installation surface;

Ensure enough space around the product for heat dissipation;

Avoid direct sunlight, water dripping, condensing and humidity over limit;

Do NOT install the product in environment with corrosive gas, inflammable gas or explosive gas;

Do NOT install the product in environment with oil contamination, dusty air or metal dust.

## 2.2 Mechanical and Electrical Installation

### 2.2.1 Installation Environment

The operation ambient temperature should be within -10°C~45°C;

Install the product on fire-proof material;

Installation vibration should be not higher than 1.14g. Make sure the product is fixed properly to the installation surface;



Ensure enough space around the product for heat dissipation;

Avoid direct sunlight, water dripping, condensing and humidity over limit;

Do NOT install the product in environment with corrosive gas, inflammable gas or explosive gas;

Do NOT install the product in environment with oil contamination, dusty air or metal dust.

## 2.2.2 Outline and Installation Dimensions

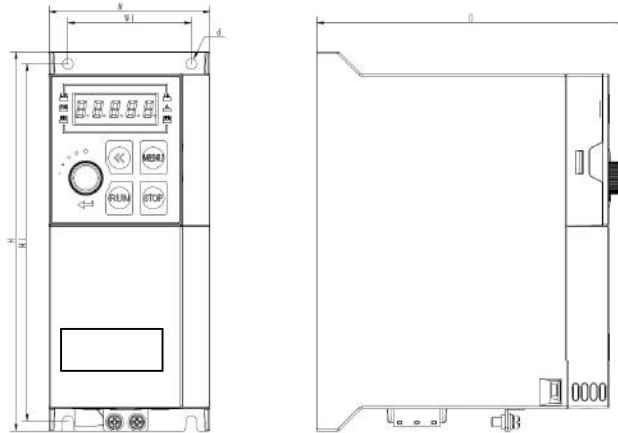

Frame	Rated Power (Heavy Load Model)		Dimensions (mm)					
	1×200-240V	3×380-480V	W	H	D	W1	H1	d
SD0	0.37-1.5Kw		72	170	138	55	160	4.5
SD1	2.2Kw	0.75-4.0Kw	82	185	163	65	175	4.5
SD2		5.5-7.5Kw	TBD					

## 2.2.3 Product Installation

### 2.1.3.1 Single Mounting and Side-by-Side Mounting

SSI80 support side-by-side mounting as well as single mounting. Enough space around the product should be kept to ensure the heat dissipation, as stated below:

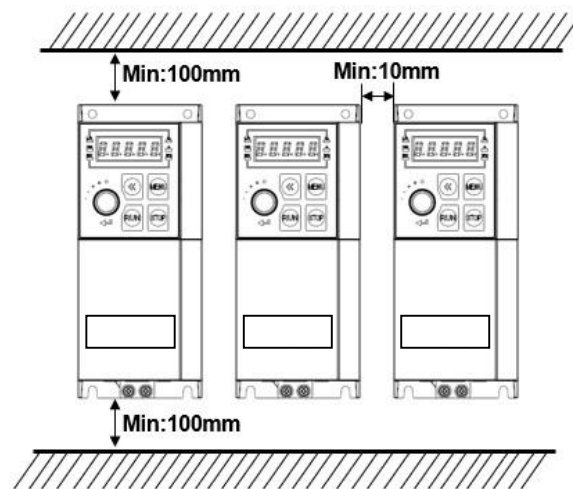

Note: If the demanded space cannot be guarantee, please date the product or lower down the ambient temperature

### 2.2.3.2 Above-Underneath Installation

When install products on top of another, the heat generated by the product underneath could increase the temperature of the product above. In this case a plate for heat isolating and guiding is necessary as shown in below picture.

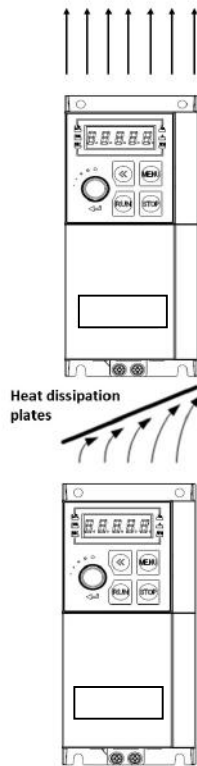

## 2.2.4 Auxiliary Components Installation

Most possible auxiliary components installed as options for running the product are shown as below:

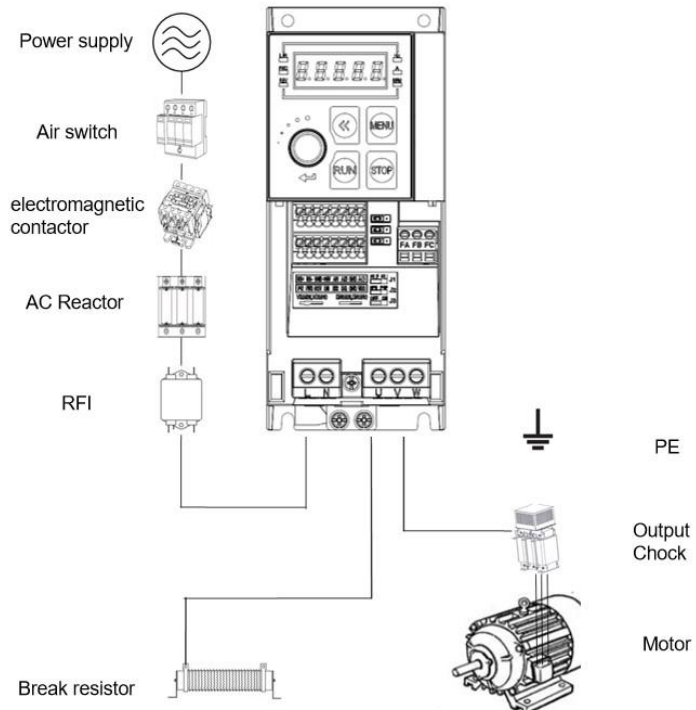

Name	Connect Point	Functions
Air Switch	First to the power supply	Cut the power automatically at high current to protect the product from further damage and limit the failure impact to other equipment
Contactora	Between the air switch and input port	Power on or power off for the product. Please limit the on-off frequency within 2 times per minute, otherwise the product may be damaged. Do NOT run/stop the motor by switching the power with contactor. Doing so may damage the product.
Input Choke	At the input port	To restrain harmonics to the line in current, or to protect the product in harsh grid with voltage distortion or unbalance, AC choke can be connected between the power supply and input port of the product. Please be aware of that AC choke will increase the voltage drop so that reduce the maximal load capacity.
RFI filter	At the input port	In order to achieve higher level of EMC performance especially for conducted emission to the grid, RFI filter should be connected between the power supply and the input port of the product.
Brake Resistor/Brake Chopper	P and BR terminal for Brake Resistor, P and N terminal for Brake Chopper	Brake resistor can be used to consume the electric power generated by the motor when the motor is running at generator mode. For product without integrated brake chopper, external brake chopper should be installed. Please be aware of that, NOT use brake resistor to protect the product at high grid voltage. Energy feedback unit should be used instead of brake resistor in case that the motor will run in generator mode for long duration or high power will be generated.
Output choke, Sine filter	At the output port	Dv/dt choke can be installed to protect the motor from damage by voltage spike in case long motor cable or traditional motor designed for grid direct connection is used. In case of very long motor cable or the motor has specific demands to limit the power loss of harmonic current, sine filter can be used.

#### 2.2.4.1 Selection Guide for air switch, fuse and contactor

Below is the guide for air switch, fuse and contactor:

Product Type Code	Air Switch (A)	Fuse (A)	Contactora (A)
SSI80-2S0R4	10	10	10
SSI80-2S0R7	25	25	16
SSI80-2S1R5	32	32	25
SSI80-2S2R2	40	40	32
SSI80-4T0R7	10	10	10
SSI80-4T1R5	10	10	10
SSI80-4T2R2	16	16	10
SSI80-4T4R0	25	25	25
SSI80-4T5R5	32	32	25
SSI80-4T7R5	40	40	32

#### 2.2.4.2 Selection Guide for Brake Resistor

The customer can select brake resistor with resistance and power as calculation below. Basically, the bigger system inertia, shorter deceleration time or more often the motor brakes, the bigger power and smaller resistance of the brake resistor are needed. Please be aware of the the resistance cannot be smaller than the limitation as stated in below table, otherwise the product may be damaged.

Brake resistance selection:

The calculation of brake resistance:  $R = UDcB2 \div (KBF \times PNom)$

UDcB --- the threshold DC voltage triggering the resistor brake function. (This value can be set in the parameter via control keypad or bus communication, normally 385Vdc for 200V product and 710Vdc for 380V product);

PNom --- The rated power of motor;

KBF --- Brake factor, the bigger inertia, shorter deceleration time, the bigger factor value is needed. KBF value is recommended in range of 0.8~2.0. 1.0 is recommended for general application, 1.5 is recommended for bigger inertia, 2.0 is recommended for steel works equipment;

Selection of brake resistor power

Instant brake power calculation:  $PB = UDcB2 \div R$

In theory, the power size of the brake resistor can be selected ad instant brake power, but a correction factor should be used based on brake frequency and brake duty to avoid wasting of cost and space. The correction factor is used as:  $Pr = KBt \times PB$

KBt = 0.12~ 0.9 is the correction factor. Normal selection is 0.12, the more frequent in acceleration/deceleration, the longer duration for deceleration, the bigger value of KBt is needed. Normally for escalator etc., a value of 0.9 is recommended, for Centrifugal equipment a value of 0.6 is recommended. (Please be ware of that the selection of power also depends on the cooling condition.

A recommendation for selection of brake resistor (For applications in which motor work in brake not very frequent and not long duration)

Line in Voltage (V)	Motor Power (kW)	Brake Resistance (Ohm)	Brake Power (W)
1×200-240	0.37	≥200	100
1×200-240	0.75	≥100	200
1×200-240	1.5	≥50	400
1×200-240	2.2	≥35	550
1×200-240	4.0	≥35	1500
3×380-440	0.75	≥300	200
3×380-440	1.5	≥160	400
3×380-440	2.2	≥100	600
3×380-440	4	≥75	800
3×380-440	5.5	≥50	1200
3×380-440	7.5	≥35	1500

### 2.2.4.3 Selection for input/output AC choke

Selection guide for input AC choke:

Line in Voltage (V)	Motor Power (kW)	Choke Current (A)	Choke Inductance (2% voltage drop) (mH)
3 x 200-240	0.37	3.0	2.70
3 x 200-240	0.75	5.0	1.60
3 x 200-240	1.5	7.4	1.10
3 x 200-240	2.2	10.0	0.80
3 x 200-240	4.0	20.0	0.70
3×380-440	0.75	3.0	4.60
3×380-440	1.5	5.0	2.80
3×380-440	2.2	7.0	2.00
3×380-440	4	10.0	1.40
3×380-440	5.5	15.0	0.93
3×380-440	7.5	20.0	0.70

Note: a. AC choke is not recommended as a good solution to control the harmonic current

b. It's not recommended to add AC choke at input for products already has built-in choke.

Selection guide for output AC choke ( $\leq 200\text{m}$  motor cable,  $dv/dt < 500\text{v}/\mu\text{S}$ )

Line in Voltage (V)	Motor Power (kW)	Choke Current (A)	Choke Inductance (2% voltage drop) (mH)
200 - 240	0.37	2.50	3.24
	0.75	4.5	1.80
	1.5	7.50	1.08
	2.2	9.60	0.84
3×380-440	0.75	2.30	6.08
3×380-440	1.5	3.80	3.68
3×380-440	2.2	5.30	2.64
3×380-440	4	9.00	1.56
3×380-440	5.5	13.0	1.08
3×380-440	7.5	17.0	0.82

### 2.2.4.4 Selection for Filters

RFI filter at input

With RFI filter as stated in below table or RFI filter with similar performance installed at the input side of the product, the product can achieve Class A1 EMC performance.

Voltage (V)	Motor Power (kW)	Rated Current for RFI filter (A)	Type of RFI Filter
220V	0.37	5	NFI-0005-SA
	0.75	5	NFI-0005-SA
	1.5	10	NFI-0010-SA
	2.2	10	NFI-0010-SA
	4.0	20	NFI-0020-SA
380V	0.75	5	NFI-0005-SA
	1.5	5	NFI-0005-SA
	2.2	10	NFI-0010-SA
	4	10	NFI-0010-SA
	5.5	20	NFI-0020-SA
	7.5	20	NFI-0020-SA

Note: The RFI filter types are recommended based on products from Shanghai Howcore. Please find more information from website of Shanghai Howcore <http://www.howcore.ir/>.

Sine Filter at Output

Below is the recommendation to select sine filter at output.

Voltage (V)	Motor Power (kW)	Rated Current (A)	L(mH)	C(uF)
220V	0.37	9	1.60	16.0
	0.75	9	1.60	16.0
	1.5	9	1.60	16.0
	2.2	9	1.60	16.0
	4.0	18	1.50	16.0
380V	0.75	10	2.50	10.0
	1.5	10	2.50	10.0
	2.2	10	2.50	10.0
	4	18	2.50	10.0
	5.5	18	1.50	16.0
	7.5	18	1.50	16.0

The values (Inductance, Capacitance) are based on sine filter circuit.

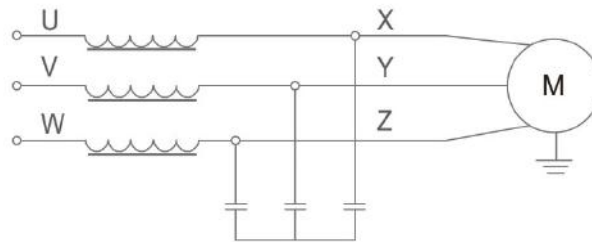

Note: the recommended values are suitable for switching frequency not low than factory default set and motor running frequency not high than 200Hz. If the application conditions are beyond the limit, please update the selection, or consult us.

You can also select sine filter from other third part. Below is the recommendation based on products from Shanghai Howcore.

Motor Power (kW)	Rated Current (A)	Type of Sine Filter
5.5	15	OSF-0015-EISA-E4M0
7.5	20	OSF-0020-EISA-E3M0

Note: Please contact Shanghai Eagletop more the limitations for switching frequency, motor frequency and more information, or check in the website of Shanghai Howcore: <http://www.howcore.ir/>.

## 2.3 SSI80 Electrical Instructions

### 2.3.1 Electrical Diagram

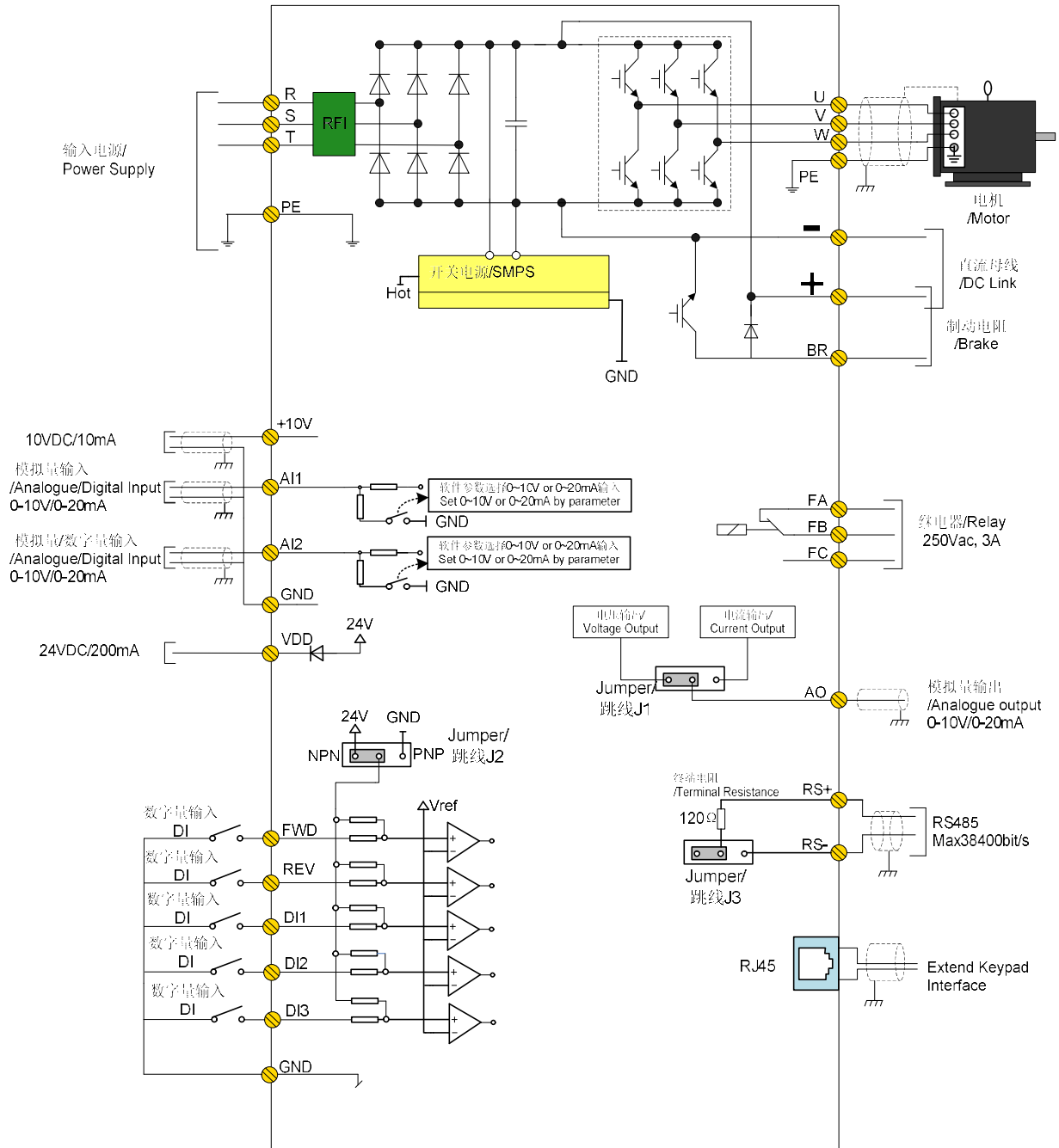

## 2.3.2 SSI80 Terminals

### 2.3.2.1 SSI80 Main circuit terminals:

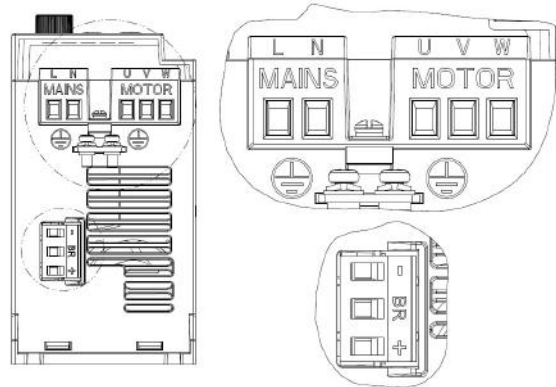

0.37-1.5KW 220V

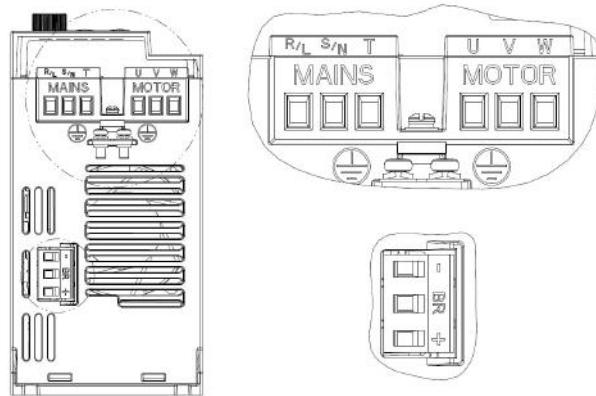

2.2KW 220V/0.75-4KW 380V

Description for power terminals:

Terminals		Function
0.37-1.5KW 220V	2.2KW 220V/0.75-4KW 380V	
L、N	R/L、S/N、T	Terminals for power inputs from grid
U、V、W	U、V、W	Terminals for Power output to motor
+、-	+、-	Terminals for DC link supply or Load sharing
+、BR	+、BR	Terminals for Brake resistor
		For ground connection

### 2.3.2.2 Recommended Specifications for Power Circuits installation

Product Type	Input Wire (mm <sup>2</sup> )	Output Wire (mm <sup>2</sup> )	Power Terminal Screw	Power Terminal Torque (N·m)	Grounding Screw	Grounding Torque (N·m)
SSI80-2S0R4	1	1	M3	0.5-0.7	M4	1.0-1.2
SSI80-2S0R7	1.5	1	M3	0.5-0.7	M4	1.0-1.2
SSI80-2S1R5	1.5	1	M3	0.5-0.7	M4	1.0-1.2
SSI80-2S2R2	2.5	1.5	M3	0.5-0.7	M4	1.0-1.2
SSI80-2S4R0	2.5	1.5	M3	0.5-0.7	M4	1.0-1.2
SSI80-4T0R7	1	1	M3	0.5-0.7	M4	1.0-1.2
SSI80-4T1R5	1	1	M3	0.5-0.7	M4	1.0-1.2
SSI80-4T2R2	1	1	M3	0.5-0.7	M4	1.0-1.2
SSI80-4T4R0	1.5	1.5	M3	0.5-0.7	M4	1.0-1.2
SSI80-4T5R5	1.5	1.5	M3	0.5-0.7	M4	1.0-1.2
SSI80-4T7R5	2.5	1.5	M3	0.5-0.7	M4	1.0-1.2

Note: The recommended Specifications are based on 25°C ambient and heavy load type conditions when use VV type single conductor wire. Please reference to the IEC standards for other conditions.

### 2.3.2.3 SSI80 Control Terminals

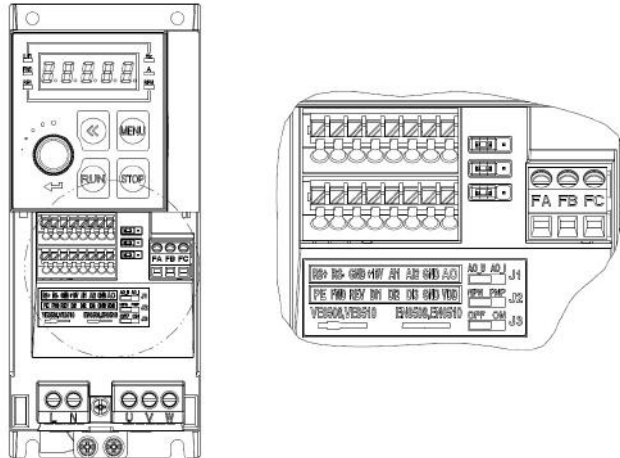

Specifications of SSI80 Control terminals:

Name	Function	Specification
FWD,REV, DI1,DI2,DI3	Digital Input	Input type: NPN and PNP Input Voltage: 0~30V; Input Impedance: 3.6kΩ;
RS+, RS-	RS485 Communication	Max Bit Rate: 38400bit/s; Configurable termination resistor (default: open)
FA-FB-FC	Relay output	Resistive Load: 250VAC 3A/30VDC 3A; Inductive Load: 250VAC 0.2A/24VDC 0.1A (cosφ=0.4);
AI1, AI2	Analogue and Digital input	Configurable as analogue voltage inputs, analogue current inputs as well as digital inputs. 1. As Analogue Voltage Inputs: Input Impedance: 10kΩ; Input Voltage Range: 0~10V; 2. As Analogue Current Inputs: Input Impedance: ≤500Ω; Input Current Range: 0~20mA;
AO1	Analogue output	Configurable as analogue voltage output or current output Output Range: 0~10V or 0~20mA; Load Capacity: As Voltage Output: Impedance > 500Ω; As Current Output: Impedance < 500Ω;
VDD	24V signal power supply	Max 50mA
+10V	10V signal power supply	Max 10mA
GND	Signal Ground	
Jumper	J1	Select VO as 0~10 Voltage output or 0~20mA current output; Default as voltage mode (Left side)
	J2	Select digital input mode as PNP or NPN mode: Default as NPN mode (Left side))
	J3	Select terminal resistor Enable or disable: Default as disable (Left side)

### 2.3.2.4 Guidance for Connecting Wires

Except for the relay outputs, Spring-Clip terminals are used for all the control signals.

Tope type terminal is recommended for the control wires with specification as below:

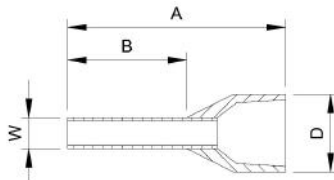



A	B	D(max)	W
14	8	3.5	1.4

Units: mm

Wire diameter specification:

Type	Minimal Diameter	Maximal Diameter
Single Conductor	0.52mm <sup>2</sup>	0.82 mm <sup>2</sup>
Multi-folded Wire	0.52mm <sup>2</sup>	0.82 mm <sup>2</sup>
Connector Lug	0.52mm <sup>2</sup>	0.52mm <sup>2</sup>

Push the wire tube into the terminal directly and the wire will be clamped automatically by the terminal spring;

To remove the wire, use a slot type screwdriver to push down the lock on the terminal then the wire will be released. The specification for the head of the screwdriver: Thickness 0.4mm, width 2.5mm;

Ideal length for the wire stripping is 9mm.

Screw fasten terminals are used for relay output:

Please select the right screwdriver to fasten the terminals. If a slot type screwdriver is used, below specification is recommended: head width 3.5mm, head thickness 0.6mm;

Ideal length for wire stripping is 6~7mm;

Diameter specification for wires:0.4~1.0mm<sup>2</sup>, Torque specification for fastening the terminal: 0.4 N·m;

### 2.3.3 Instructions for control terminals

#### 2.3.3.1 Electrical connection for Digital Inputs

For NPN inputs, below connection is recommended:

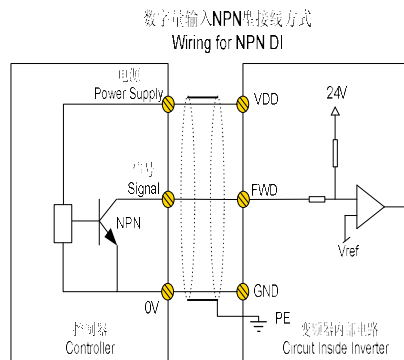

For PNP inputs, below connection is recommended:

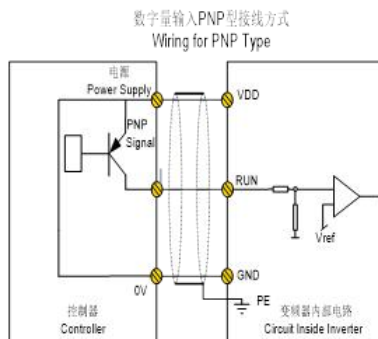

### 2.3.4 EMC Guidance for Electrical Wiring

#### 2.3.4.1 EMC Standards

SSI80 follow the IEC standards: IEC/EN61800-3 (Adjustable speed electrical power drive systems part 3:EMC requirements and specific test methods).

IEC/EN61800-3 defines the EMC demands from two aspects: EMC interference and EMC immunity. EMC interference includes

radiated emission, conducted emission and low frequency current emission. EMC immunity includes radiated immunity, conducted immunity, surge, burst, ESD and immunity to low frequency disturbance from the grid power supply (voltage dips, notch, sag and fluctuation, unbalance, distortion and frequency variation). AD80 follow all the demands except for:

External AC choke is needed to achieve IEC 61000-3-2/IEC 61000-3-12 for drives below 30kW (refer to 2.2.2.3)

External RFI filter is needed to achieve class C1 or C2 (IEC 61800-3) level conducted emission performance (refer to 2.2.2.4). If no external RFI filter is installed, AD80 is not intended to be used on a low-voltage public network which supplies domestic premises directly.

#### 2.3.4.2 Guidance for EMC Noise Handling

While used on a common supply with other equipment, even though an RFI filter is built in AD80 already too limited the conducted emission, depending on the sensitivity of equipment and the background of the environment, there is still certain possibility to disturb other equipment to malfunction. Below measures are recommended to avoid the EMC issue:

Install an RFI filter before the product

Install a power filter before the equipment sensitive to EMC noise

Isolate the power supply for the product from the equipment sensitive to EMC noise, normally with isolation transformer.

Use shielded wire for control signals and shielded cable for motor, ground the shielding properly

Avoid wiring the control signals in parallel with power circuits, especially, avoid tiring the control wires together with the power cables. If a cross between control wire and power cable cannot be avoided, please cross the wires perpendicularly.

If no reliable grounding point or no shielded motor cable available, please use an additional wire to connect the motor shell to the PE terminal and layout this wire together with the 3 motor phases as close and tight as possible.

Installing ferrite cores at the input or the output of the product as common choke helps a lot to solve the EMC issue in most cases.

#### 2.3.4.3 Leakage Current Handling

As stated in 2.2.3.4, there are different reasons for leakage current. The leakage current issue should be handled properly to avoid any mis operation of the residual-current circuit breaker or interference to other equipment. Below are the recommendations:

Lower the switching frequency and use as short as possible motor cable to limit the high frequency leakage current;

Install AC choke or sine filter at the output of the product;

Take measures to limit the unbalance of the power supply.

#### 2.3.4.4 Handling the Induced Voltage

In case there is no grounding point, there could be induced voltage on the motor shell or other metals connected to the motor shell. Connecting the motor shell to the PE terminal of the product helps to limit the induced voltage. But please be aware that, the only safe way is to ground the motor and product properly.

#### 2.3.4.5 Grounding

Please ground the system as blow:

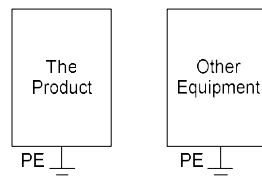

Use thick wire for ground to reduce the grounding impedance;

Use as short as possible grounding wire;

Grounding the product to the ground point as close as possible;

Use four-wire motor cable, and connect the motor shell to the PE terminal of the product with one of the four wires, and grounding this wire to the dedicated grounding point;

Put the grounding wires far away from the input/outputs of the equipment which are sensitive to EMC Noise.

## Chapter 3 Parameters

### 3.1 List of parameters

Parameter Number	Parameter Name	Value Range	Unit	Factory Default
Parameter Group 0: General Control Mode and Commands				
P0-01	Control Mode	0: Speed Mode Speed Sensor less		0
*P0-02	Motor Control Principle	0: V/F; 1: Vector Control 1		1
P0-03	Macro-program	0: Invalid; 1: Pump Control; 2: Simple PLC		0
*P0-04	Torque Characteristics	0: CT; 1: VT		0
*P0-05	Motor Speed Direction	0: Clockwise 1: Anticlockwise 2: Bidirectional		2
P0-10	Speed Set Source Selection	0: main set source 1: Multi preset value with priority 2: Calculation of main set source and additional set source. 3: Switchover between main set source and additional set source. 4: Switchover between main set source and the calculation of main set source and additional set source 5: Switchover between additional set source and the calculation of main set source and additional set source Selecting 4 or 5 works similar as selecting 3.		2
P0-11	Main Set Source	0: No function; 1: Terminal AI1 2: Terminal AI2 5: Pulse input, use pulse input as set source 10: Multi preset value 0 + Up/Down 11: Multi preset values 20: Communication 21: Process PID 30: Keypad		1
P0-12	Additional Set Source	Same as P0-11		20
P0-14	Set Value Calculation from Main and Additional Source	0: Main Set Source + Additional Set Source 1: Main Set Source - Additional Set Source 2: Maximal Value of Main and Additional Set Source 3: Minimal Value of Main and Additional Set Source		0
P0-15	Speed Set Range	0: 0~P0-16; 1: -P0-16~P0-16		0
P0-16	Base Value for Speed Set	0.0~400.0		50.0
P0-17	Control Site	0: Terminal or Bus Communication 1: Terminal 2: Bus Communication		0
P0-18	Selection of Communication Control Source	0: Null 1: Local RS485		1
P0-30	Multi Preset Value0	-100.00~100.00	%	0.00
P0-31	Multi Preset Value1	-100.00~100.00	%	0.00
P0-32	Multi Preset Value2	-100.00~100.00	%	0.00
P0-33	Multi Preset Value3	-100.00~100.00	%	0.00
P0-34	Multi Preset Value4	-100.00~100.00	%	0.00
P0-35	Multi Preset Value5	-100.00~100.00	%	0.00
P0-36	Multi Preset Value6	-100.00~100.00	%	0.00
P0-37	Multi Preset Value7	-100.00~100.00	%	0.00
P0-38	Multi Preset Value8	-100.00~100.00	%	0.00
P0-39	Multi Preset Value9	-100.00~100.00	%	0.00
P0-40	Multi Preset Value10	-100.00~100.00	%	0.00

Parameter Number	Parameter Name	Value Range	Unit	Factory Default
P0-41	Multi Preset Value11	-100.00~100.00	%	0.00
P0-42	Multi Preset Value12	-100.00~100.00	%	0.00
P0-43	Multi Preset Value13	-100.00~100.00	%	0.00
P0-44	Multi Preset Value14	-100.00~100.00	%	0.00
P0-45	Multi Preset Value15	-100.00~100.00	%	0.00
P0-46	UP/DOWN Step Value	0.01~50.00		0.10
P0-47	Save Up/Down Set Value	0: Not Save 1: Save when Stop 2: Save when Power Down		0
P0-48	Jog Speed	0.0~400.0HZ	Hz	5.0
P0-49	Ramp Time Resolution	0: 0.1s; 1: 0.01s		1
P0-50	Ramp 1 Type	0: Linear; 1: S ramp		0
P0-51	Ramp 1 Ramp Up Time	0.05~655.35	s	*
P0-52	Ramp 1 Ramp Down Time	0.05~655.35	s	*
P0-53	Ramp 2 Type	0: Linear; 1: S ramp		0
P0-54	Ramp 2 Ramp Up Time	0.05~655.35	s	*
P0-55	Ramp 2 Ramp Down Time	0.05~655.35	s	*
P0-56	Ramp 3 Type	0: Linear; 1: S ramp		0
P0-57	Ramp 3 Ramp Up Time	0.05~655.35	s	*
P0-58	Ramp 3 Ramp Down Time	0.05~655.35	s	*
P0-59	Ramp 4 Type	0: Linear; 1: S ramp		0
P0-60	Ramp 4 Ramp Up Time	0.05~655.35	s	*
P0-61	Ramp 4 Ramp Down Time	0.05~655.35	s	*
P0-62	Jog Ramp Time	0.05~655.35	s	*
P0-63	S Ramp Up Initiate Period	0.05~655.35	s	*
P0-64	S Ramp Up Termination Period	0.05~655.35	s	*
P0-65	S Ramp Down Initiate Period	0.05~655.35	s	*
P0-66	S Ramp Down Termination Period	0.05~655.35	s	*
P0-80	Local Address	1~127		1
P0-81	Baud Rate	0: 2400 1: 4800 2: 9600 3: 19200 4: 38400 5~9: Reserved		2
P0-82	Communication Data Format (Parity/Stop Bits)	0: Even parity (1 stop bit) 1: Odd parity (1 stop bit) 2: No parity (1 stop bit) 3: No parity (2 stop bit)		0
P0-83	Min. Communication Response Delay	0.000~0.500	s	0.002
P0-84	Max. Communication Response Delay	0.010~10.000	s	5.000
P0-85	Message Response	0: Normal Responses 1: Only Response Exceptional Message 2: Not Response		0
P0-86	Parameter (Set by Communication) Saving at Power Down	0: Not Save Parameter at Power Down 1: Save Parameter at Power Down		0
P0-88	Communication Timeout Time	0.01~650.00	s	1.00
P0-89	Communication Timeout Response Function	0: No Function 2: Stop Motor 3: Jogging 4: Run with Max Frequency P5-03 5: Alarm Fault and Trip to stop 6: Warning		0
P0-90	Reset Communication Timeout	0: No Action; 1: Reset the Timeout		0
<b>Parameter Group 1: Basics for Inverter and Motor Control</b>				
P1-00	Switching Frequency	2~16; 2~16 kHz		*
*P1-01	Grid Type	2~122		*
*P1-02	Motor Type	0: Induction Motor		0

Parameter Number	Parameter Name	Value Range	Unit	Factory Default
*P1-03	Rated Motor Power	0.12~450	kW	*
*P1-04	Rated Motor Voltage	50~1000	V	*
*P1-05	Rated Motor Frequency	20~400	Hz	*
*P1-06	Rated Motor Current	0.1~1200	A	*
*P1-07	Rated Motor Speed	100~24000	rpm	*
*P1-08	Rated Motor Torque	0.1~6553.5	N·m	*
*P1-13	Autotuning for Motor Parameters	0: No Function; 1: Simple Static Motor Auto Tuning 2: Complete Static Motor Auto Tuning		0
*P1-14	Stator Resistance (Rs)	Depends on motor model	Ω	*
*P1-15	Rotor Resistance (Rr)	Depends on motor model	Ω	*
*P1-16	Stator Leakage Reactance (Xl)	Depends on motor model	Ω	*
*P1-17	Main Reactance (Xh)	Depends on motor model	Ω	*
*P1-24	Number of Motor Poles	2~100	P	4
*P1-26	Motor Cable Length	0~150	m	10
P1-32	Load Compensation Gain for Low Speed	0~199	%	100
P1-33	Load Compensation Gain for High Speed	0~199	%	100
P1-34	Motor Magnet Current at 0 Speed	0~300	%	100
P1-35	Cut in Speed for Normal Magnet Current	0.0~10.0	Hz	0.0
P1-37	Slip Compensation Gain	-400~399	%	*
P1-38	Slip Compensation Time Constant	0.05~5.00	s	*
P1-39	Resonance Damping Gain	0~3000	%	*
P1-40	Time Constant for Resonance Damping Filter	0.005~0.050	s	0.005
P1-53/P1-55/P1-57/P1-59/P1-61	Voltage for V/F curve points	0.0~999.9	V	*
P1-54/P1-56/P1-58/P1-60/P1-62	Frequency for V/F curve Points	0.0~590.0	Hz	*
*P1-64	IM Start Method	0: Direct Start; 1: Fly start		0
P1-67	Min Valid Speed Set	0.00~50.00	Hz	0.00
P1-68	Bypass Range for IM Low Speed	0.0~20.0	Hz	0.0
P1-70	Delay Time at Start	0.0~10.0	s	0.0
P1-71	Delay Function at Start	0: Free Coast; 1: DC Hold		0
P1-72	DC Hold Current	0~150	%	50
P1-80	Function at Stop	0: Free Coast; 1: DC hold		0
P1-81	Cut in Speed for Function at Stop	0.0~400.0	Hz	0.0
P1-82	DC Brake Current (IM)	0~150	%	50
P1-83	DC Brake Time (IM)	0.0~60.0	s	2
P1-84	DC Brake Cut in Speed (IM)	0.0~400.0	Hz	0.0
P1-85	Demagnetizing Rate at DC Cut in	0~100	%	100
P1-91	Brake Function	0: No Function; 1: Resistor Brake; 2: AC Brake		0
P1-92	Max AC Brake Current	0~150	%	100
P1-93	AC Brake Gain	1.0~2.0		1.4
P1-94	Threshold Voltage for Brake Function	Grid Dependent	V	*
P1-95	Resistor Brake Resistance	5~65535	Ω	*
<b>Parameter Group 2: Digital Terminal Functions</b>				
P2-00	DI Positive-Negative Logic Selection	0~65535		0
P2-01	DO/Relay Positive-Negative Logic Selection	0~65535		0
P2-04	DI Filter time	2~16	ms	4
P2-05	FWD Input Function Selection			10
P2-06	REV Input Function Selection	0: No Function; 1: Reset		12
P2-07	DI Function Selection - Terminal D1	2: Coast to Stop (Negative Logic)		22
P2-08	DI Function Selection -	3: Coast to Stop and Reset (Negative Logic)		23

	Terminal D2	4: Stop (Negative Logic) 10: Run 11: Forward/Reverse Selection 12: Run in Reverse Direction 13: Latched run forward 14: Latched run reverse 15: Forward Jog 16: Reverse Jog 17: Latched stop 20: Forbid Forward 21: Forbid Reverse 22: Preset Value Command Bit 1 23: Preset Value Command Bit 2 24: Preset Value Command Bit 3 25: Preset Value Command Bit 4 26: Ramp Time Selection Bit 1 27: Ramp Time Selection Bit 2 30: Speed UP 31: Speed DOWN 32: Counter A 34: Reset Counter A 35: Counter B 37: Rest Counter B 40: Pulse Input 41: Switch Set Source 42: Switch Speed Mode/Torque Mode 50: External Fault Input 51: Freeze PID output		
P2-09	DI Function Selection - Terminal D3			24
P2-21	Action for DI as External Fault Input	0: No Action; 2: Stop and Warning 3: Jog and Warning 4: Run to Max Speed P5-03 and Warning 5: Alarm Fault and Trip to stop 6: Warning		0
P2-28	Relay Output Function Selection - RL1	0: No operation; 1: Drive ready, 2: Remote control ready 3: Drive ready/stop 4: Drive running, the drive is running; 5: Drive running/No warning, the drive is running and no warning is present; 6: Run in current range 7: Run on reference 8: Reverse 10: Alarm 11: Alarm or warning 12: Thermal warning 13: Ready 14: Remote ready 15: Bus OK 20: Out of current range 21: Below current low 22: Above current high 23: Out of frequency range 24: Below frequency low, 25: Above frequency high 26: Out of feedback range 27: Below feedback low 28: Above feedback high 29: Out of reference range 30: Below reference low 31: Above reference high 40: Drive in Local mode; 41: Drive in Remote mode; 42: Mech. brake control, 43: External alarm 44: Unbalance warning		10

Parameter Number	Parameter Name	Value Range	Unit	Factory Default
P2-29	Relay on Delay Time - RL1	0.00~600.00	s	0.00
P2-30	Relay off Delay Time - RL1	0.00~600.00	s	0.00
P2-46	Save DI Counter Value at Power down	0: Save None; 1: Save Counter A 2: Save Counter B; 3: Save Both Counter A and B		0
Parameter Group 3: Analogue Terminal Functions				
P3-00	Signal Type - Terminal AI1	0: Analogue Voltage 1: Analogue Current		0
P3-01	Terminal AI1 Filter Time	0.00~10.00	s	0.01
P3-02	Zero Voltage Dead Band - Terminal AI1	0.00~20.00	V/mA	0.00
P3-03	Min Input Voltage - Terminal AI1	0.00~P3-04	V	0.00
P3-04	Max Input Voltage - Terminal AI1	P3-03~10.00	V	10.00
P3-05	Min Input Current - Terminal AI1	0.00~ P3-06	mA	0.00
P3-06	Max Input Current - Terminal AI1	P3-05~20.00	mA	20.00
P3-07	Set Value/Feedback Value Versus Min Input -Terminal AI1	-200.00~200.00	%	0.00
P3-08	Set Value/Feedback Value Versus Max Input -Terminal AI1	-200.00~200.00	%	100.00
P3-09	Signal Type - Terminal AI2	0: Analogue Voltage; 1: Analogue Current		1
P3-10	Terminal AI2 Filter Time	0.00~10.00	s	0.01
P3-11	Zero Voltage Dead Band - Terminal AI2	0.00~20.00	V/mA	0.00
P3-12	Min Input Voltage - Terminal AI2	0.00~P3-13	V	0.00
P3-13	Max Input Voltage - Terminal AI2	P3-12~10.00	V	10.00
P3-14	Min Input Current - Terminal AI2	P3-15~19.99	mA	0.00
P3-15	Max Input Current - Terminal AI2	P3-14~20.00	mA	20.00
P3-16	Set Value/Feedback Value Versus Min Input -Terminal AI2	-200.00~200.00	%	0.00
P3-17	Set Value/Feedback Value Versus Max Input -Terminal AI2	-200.00~200.00	%	100.00
P3-48	Analogue Live Zero Timeout Time	1~99	s	10
P3-49	Live Zero Timeout Function	0: No Action 2: Stop and Warning 3: Jog and Warning 4: Run at Max Speed P5-03 and Warning 5: Alarm Fault and Trip to stop		0
P3-50	Signal Type - Terminal AO1	0: 0~20mA 1: 4~20mA 3: 0~10V		3
P3-51	Output Function Selection- AO1	0: No function 1: Output frequency 2: Output current 3: Output Power 4: Motor Speed 5: Output voltage 10: Set Value 11: Feedback 13: Set Value from Bus 14: Pulse input 1 input frequency 15: Terminal AI1 input value 16: Terminal AI2 input value 20: DC link voltage 30: Output Torque		0
P3-52	Value Versus Min Output - AO1	0.00~200.00	%	0.00
P3-53	Value Versus Max Output - AO1	0.00~200.00	%	100.00
P3-54	Min Output Voltage/Current - AO1	0.00~P3-55		0.00 /4.00
P3-55	Max Output Voltage/Current - AO1	P3-54~10.00/20.00		10.00 /20.00
P3-68	Min Set Value from Keypad	-200.00~200.00	%	0.00
P3-69	Max Set Value from Keypad	-200.00~200.00	%	100.00

Parameter Number	Parameter Name	Value Range	Unit	Factory Default
<b>Parameter Group 4: Process PID and Other Controllers</b>				
P4-00	Process PID Feedback Source	0: No Function 1: Terminal AI1 2: Terminal AI2 5: Pulse Input 1 20: Bus Communication		0
P4-01	Process PID Set Source	0: No Function 1: Terminal AI1 2: Terminal AI2 5: Pulse Input 11 10: Preset Value 0 + UP/DOWN 11: Multi Preset Value 20: Bus Communication 30: Keypad		0
P4-02	Fiducial Value for Process PID Set/Feedback	0.0~3000.0		50.0
P4-04	Process PID Control Logic: Positive/Negative	0: Positive 1: Negative		0
P4-05	Process PID Anti Windup	0: Disable 1: Enable		1
P4-06	Cut-in Frequency for Process PID Speed Mode	0.0~200.0	Hz	0.0
P4-07	Proportional Gain - Process PID 1	0.0~10.00		0.01
P4-08	Integral Time - Process PID 1	0.01~655.35	s	655.35
P4-09	Differentiating Time - Process PID 1	0.00~10.00	s	0.00
P4-13	Process PID Differential Limit	1.0~50.0		5.0
P4-14	Error Tolerance Limit to Enable Process PID	0.0~200.0	%	0.1
P4-15	Process PID Out/In Mode to Error Tolerance	0~2		0
P4-18	Process PID Output Low Limit	-100.00~100.00	%	0.00
P4-19	Process PID Output High Limit	-100.00~100.00	%	100.00
P4-22	Process PID Integral Output Low Limit	-100.00~100.00	%	0.00
P4-23	Process PID Integral Output High Limit	-100.00~100.00	%	100.00
P4-52	Proportional Gain - Current Limit Controller	0~500	%	100
P4-53	Integration Time - Current Limit Controller	0.000~2.000	s	0.020
P4-54	Filter Time - Current Limit Control	2.0~100.0	ms	*
<b>Parameter Group 5: Limitation, Protection and Failure Detection</b>				
*P5-02	Motor Low Speed Limit	0.0~590.0	Hz	0.0
*P5-03	Motor High Speed Limit	0.0~590.0	Hz	65.0
P5-07	Max Current Limit	0~300	%	*
*P5-08	Max Output Frequency Limit	0.0~590.0	Hz	65.0
P5-09	Threshold for Low Current Warning	0.00~P9-16	A	0.0
P5-10	Threshold for High Current Warning	0.00~P9-16	A	*
P5-11	Threshold for Low Speed Warning	0.0~590.0	Hz	0.0
P5-12	Threshold for High Speed Warning	0.1~590.0	Hz	65.0
P5-13	Threshold for Low Set Value Warning	-200.00~200.00	%	0.00
P5-14	Threshold for High Set Value Warning	-200.00~200.00	%	100.00
P5-15	Threshold for Low Feedback Warning	-200.00~200.00	%	0.00



Parameter Number	Parameter Name	Value Range	Unit	Factory Default
P5-16	Threshold for High Feedback Warning	-200.00~200.00	%	100.00
*P5-17	Enable Motor Phase Loss Protection	0: Disable 1: Enable		1
P5-18	Enable Current Limit/Torque Limit Warning	0: Disable 1: Enable		1
P5-26	Motor Thermal Protection Function	0: No Function 1: ETR Warning 2: ETR Alarm Fault 3: ETR Warning for Self-cooled Motor 4: ETR Alarm Fault for Self-cooled Motor		0
P5-27	Motor Overload Protection Time	0.1~60.0	min	2.0
P5-28	Threshold for Motor Overload Protection	100~160	%	150
P5-29	Function at Mains Phase Loss	0: No Action 1: Only Warning 2: Trip to stop and Alarm Fault (Heavy Load) 3: Trip to stop and Alarm Fault (Mid Load) 4: Trip to stop and Alarm Fault (Light Load)		3
P5-30	Alarm/Fault Lock Handling	0: Not Lock, Alarm/Fault Resettable without Re-Power On 1: Lock, Alarm/Fault Lock Resettable only after Re-Power On		1
P5-31	Delay Time to Alarm Current Limit Fault	0~60	s	60
P5-33	Action at Warning	0: Trip to stop and Alarm Fault directly 1: Warning and Re-catch Motor after Failure Disappear		1
P5-34	Method to Re-catch Motor at Warning	0: Speed Track (IM/PM) and Angle Track (Fly start) 1: Direct Re-catch		0
<b>Parameter Group 6: Keypad Operation and Display</b>				
P6-03	Customer Defined Value for 0 Speed	0.0~6553.5		0.0
P6-04	Customer Defined Value for Max Speed	0.0~6553.5		100.0
P6-05	Keypad Display Option	0~8191		0
P6-31	Local/Remote Mode Selection	0: Remote Mode 1: Local Mode		0
P6-34	Lock Keypad for Parameter Edit	0: Disabled 1: Enabled and Lock		0
<b>Parameter Group 7: Auxiliary and Special Functions</b>				
P7-00	Special Operation Function	0: No Function 9: Reset Parameters to Factory Defaults		0
P7-01	Function at Re-Power (for Local Mode Only)	0: Resume with Set Value as Set before Re-power 1: Not Run, but Keep Set Value as Set before Re-power 2: Not Run and Clear Set Value		1
*P7-10	Min Switch Frequency	2~16: 2~16 kHz	kHz	2
*P7-11	Over Modulation Coefficient	90.0~105.5	%	100.0
*P7-12	DC-Link Voltage PWM Compensation Function	0: Compensate Average DC voltage 2: Compensate DC Ripple Voltage		0
P7-13	DC-link Voltage PWM Compensation Disable at VF control	0: Disable 1: Enable		1
P7-14	Dead Time Compensation Adjustment Coefficient	0~200	%	100
P7-17	Max Speed for Dead Time Compensation	20~590	Hz	*

Parameter Number	Parameter Name	Value Range	Unit	Factory Default
P7-26	Function at Mains Voltage Sag	0: No Function 1: Passive Ramp Down 2: Passive Ramp Down, Trip 3: Coast and Fly start 4: KEB Control 5: KEB Control, Trip 6: Trip to stop and Alarm		0
P7-27	Threshold Triggering Mains Voltage Sag Function	100~220/380	V	*
P7-28	KEB Control Gain	0 ~ 500	%	100
P7-36	Method to Reset Alarm Fault	0: Reset by Command 1~10: Auto Reset for 1~10 Times 11: Auto Reset for Unlimited Times		0
P7-37	Alarm Auto Reset Waiting Time	0~600	s	10
*P7-38	VT Function Level	40~90	%	90
P7-46	Threshold Voltage for OVC Function	Grid Voltage Dependent	V	*
P7-47	OVC Function	0: Disable 1: Enable with Mode 1 2: Enable with Mode 2		*
P7-48	OVC Integral Time	0.01~0.10	s	*
P7-49	OVC Proportional Gain	0~200	%	*
P7-50	Bypass Speed Start 1	0.0~590.0	Hz	0.0
P7-51	Bypass Speed End 1	0.0~590.0	Hz	0.0
P7-52	Bypass Speed Start 2	0.0~590.0	Hz	0.0
P7-53	Bypass Speed End 2	0.0~590.0	Hz	0.0
P7-54	Bypass Speed Start 3	0.0~590.0	Hz	0.0
P7-55	Bypass Speed End 3	0.0~590.0	Hz	0.0
<b>Parameter Group 8: Basic and Running Information</b>				
P8-00	PU SW Version			
P8-30	Total Days with Power On	0~9999	d	
P8-31	Total Running Hours	0~60000	h	
P8-32	Total Energy Consumed (kWh)	0~65535	kWh	
P8-33	Number of Power Ups	0~65535		
P8-34	Number of Over-Temperatures	0~65535		
P8-35	Number of Over-Voltages	0~65535		
P8-36	Reset Consumed Energy Counter	0: Not Reset 1: Reset		0
P8-37	Reset Running Hours Counter	0: Not Reset 1: Reset		0
P8-40~P8-49	Alarm Log			
P8-50~P8-59	Warnings Log			
<b>Parameter Group 9: Real Time Running Status Monitoring</b>				
P9-00	Control Word	0~65535		
P9-01	Status Word	0~65535		
P9-02	Set Value	-4999.0~4999.0		
P9-04	Motor Speed	0~24000	rpm	
P9-05	Output Power	0.000~655.35	kW	
P9-06	Output Voltage	0.0~6553.5	V	
P9-07	Output Frequency	0.0~590.0	Hz	
P9-08	Output Current	0.0~655.35	A	
P9-09	Output Torque	-200.0~200.0	%	
P9-10	Motor Thermal Load Status	0~100	%	
P9-11	DC Link Voltage	0~65535	V	
P9-13	Heatsink or IGBT Temperature	-128~127	°C	
P9-14	Inverter Thermal Load Status	0~255	%	
P9-15	Nominal Inverter Current	0.0~6553.5	A	
P9-16	Max Inverter Current	0.0~6553.5	A	
P9-17	Power Board Temperature	-128~127	°C	
P9-18	Rectifier Temperature	-128~127	°C	
P9-19	PID Set Value	-200.0~200.0	%	
P9-20	PID Feedback Value	-200.0~200.0		
P9-21	PID Output	-200.0~200.0	%	
P9-22	Digital Input	0~65535		

Parameter Number	Parameter Name	Value Range	Unit	Factory Default
P9-23	AI1 Analogue Input Type	0: 0~10V 1: 0~20mA		
P9-24	AI1 Input Value	0.00-20.00	V/mA	
P9-25	AI2 Analogue Input Type	0: 0~10V 1: 0~20mA		
P9-26	AI2 Input Value	0.00-20.00	V/mA	
P9-39	Relay Output Status	0~65535		
P9-40	AO1 Output	0.00-20.00	V/mA	
P9-45	Counter A Value	0~65535		
P9-46	Counter B Value	0~65535		
P9-47	Set Value from Bus Communication	-32768~32767		
P9-48	Variable Defined by Customer	0~6553.5		
Parameter Group 19: Simple PLC function				
P19-00	SPLC control mode	0 : once running then keep running 1 : once running then stop 2 : cycle running		0
P19-01	SPLC store selection	0 : No function 1 : save at Stop 2 : save at Power down		0
P19-02	SPLC reset times reset	0: invalid 1: Reset times are reset		0
P19-10	SPLC multi-speed0	-100.00%~100.00%	%	0
P19-11	SPLC multi-speed1	-100.00%~100.00%	%	0
P19-12	SPLC multi-speed2	-100.00%~100.00%	%	0
P19-13	SPLC multi-speed3	-100.00%~100.00%	%	0
P19-14	SPLC multi-speed4	-100.00%~100.00%	%	0
P19-15	SPLC multi-speed5	-100.00%~100.00%	%	0
P19-16	SPLC multi-speed6	-100.00%~100.00%	%	0
P19-17	SPLC multi-speed7	-100.00%~100.00%	%	0
P19-18	SPLC multi-speed8	-100.00%~100.00%	%	0
P19-19	SPLC multi-speed9	-100.00%~100.00%	%	0
P19-20	SPLC multi-speed10	-100.00%~100.00%	%	0
P19-21	SPLC multi-speed11	-100.00%~100.00%	%	0
P19-22	SPLC multi-speed12	-100.00%~100.00%	%	0
P19-23	SPLC multi-speed13	-100.00%~100.00%	%	0
P19-24	SPLC multi-speed14	-100.00%~100.00%	%	0
P19-25	SPLC multi-speed15	-100.00%~100.00%	%	0
P19-26	SPLC step0 ramp time	0.0~6000.0	S	0
P19-27	SPLC step1 ramp time	0.0~6000.0	S	0
P19-28	SPLC step2 ramp time	0.0~6000.0	S	0
P19-29	SPLC step3 ramp time	0.0~6000.0	S	0
P19-30	SPLC step4 ramp time	0.0~6000.0	S	0
P19-31	SPLC step5 ramp time	0.0~6000.0	S	0
P19-32	SPLC step6 ramp time	0.0~6000.0	S	0
P19-33	SPLC step7 ramp time	0.0~6000.0	S	0
P19-34	SPLC step8 ramp time	0.0~6000.0	S	0
P19-35	SPLC step9 ramp time	0.0~6000.0	S	0
P19-36	SPLC step10 ramp time	0.0~6000.0	S	0
P19-37	SPLC step11 ramp time	0.0~6000.0	S	0
P19-38	SPLC step12 ramp time	0.0~6000.0	S	0
P19-39	SPLC step13 ramp time	0.0~6000.0	S	0
P19-40	SPLC step14 ramp time	0.0~6000.0	S	0
P19-41	SPLC step15 ramp time	0.0~6000.0	S	0
P19-42	SPLC step0 running time	0.0~6000.0	S	0
P19-43	SPLC step1 running time	0.0~6000.0	S	0
P19-44	SPLC step2 running time	0.0~6000.0	S	0
P19-45	SPLC step3 running time	0.0~6000.0	S	0
P19-46	SPLC step4 running time	0.0~6000.0	S	0
P19-47	SPLC step5 running time	0.0~6000.0	S	0
P19-48	SPLC step6 running time	0.0~6000.0	S	0
P19-49	SPLC step7 running time	0.0~6000.0	S	0
P19-50	SPLC step8 running time	0.0~6000.0	S	0
P19-51	SPLC step9 running time	0.0~6000.0	S	0

Parameter Number	Parameter Name	Value Range	Unit	Factory Default
P19-52	SPLC step10 running time	0.0~6000.0	S	0
P19-53	SPLC step11 running time	0.0~6000.0	S	0
P19-54	SPLC step12 running time	0.0~6000.0	S	0
P19-55	SPLC step13 running time	0.0~6000.0	S	0
P19-56	SPLC step14 running time	0.0~6000.0	S	0
P19-57	SPLC step15 running time	0.0~6000.0	S	0
P19-80	Average Speed	0~65535	RPM	
P19-81	Current Running step	0~15		
P19-82	Current Running step time	0.0~6553.5	S	
P19-83	SPLC reset times	0~65535		
Parameter Group 20: Pump control function				
P20-00	pump control mode	0 : pressure mode		0
P20-01	minimum output frequency	0.00~P20-02	%	40
P20-02	maximum output frequency	P20-01~100.00	%	100
P20-60	Sleep enable selection	0 : disable 1 : enable		0
P20-61	Sleep frequency threshold	0.00~100.00	%	2
P20-62	Sleep pressure threshold	0.00~100.00	%	2
P20-63	Sleep detection time	0.0~300.0	S	10
P20-64	minimum sleep time	0.0~1800.0	S	300
P20-65	wake up pressure threshold	0.00~100.00	%	10
P20-66	wake up detection time	0.0~60.0	S	1

Note: a. Parameters marked with '\*' on the parameter number cannot be changed during motor running. '\*' in the Factory default column means the default value vary with the different product types.

## 3.2 Detailed Description for Parameters

### 3.2.1 Parameter Group 0: General Control Mode and Commands

Parameter Number	Parameter Name	Value Range	Unit	Factory Default
P0-01	Control Mode	0: Speed Mode Speed Sensor less		0

0: Speed Mode Speed Savorless, Enables speed control (without speed feedback from motor) with automatic slip compensation for almost constant speed at varying loads. Compensations are active but can be disabled.

Par. No.	Name	Range	Unit	Default
*P0-02	Motor Control Principle	0: V/F 1: Vector Control 1		1

Select the motor control principle.

0: V/F, for special motor or parallel connected motors in special motor applications. When V/F is selected the characteristic of VF curve can be set in parameters P1-53/P1-55/P1-57/P1-59/P1-61 for voltages and P1-54/P1-56/P1-58/P1-60/P1-621 for frequencies

1: Vector Control 1, Vector Control by decoupling the magnet current and torque current, suitable for most general applications. Correct motor parameters are important to achieve the best performance. Only VC 1 supports PM motor;

Par. No.	Name	Range	Unit	Default
P0-03	Macro-program	0: Invalid; 1: Pump Control; 2: Simple PLC		0

0: Macro-program invalid

1: enable Pump application, please refer Group 20 detail description.

2: enable simple PLC application, please refer Group 19 detail description.

Par. No.	Name	Range	Unit	Default
*P0-04	Torque Characteristics	0: CT 1: VT		0

Select the torque characteristic of the load.

0: Constant torque, Load keeps high torque to the motor also at low speed, applies to most industry applications.

1: Variable torque, Load torque to the motor varies with the speed change, normally lower torque at lower speed, usually applies to fan or pump applications.

Par. No.	Name	Range	Unit	Default
*P0-05	Motor Speed Direction	0: Clockwise 1: Anticlockwise 2: Bidirectional		2

Select the motor speed direction(s). It can be used to prevent unwanted motor direction.

0: Clockwise, the motor shaft rotates in clockwise direction, this setting prevents the motor from running in counter clockwise direction;

1: Anticlockwise, motor shaft rotates in anticlockwise direction, this setting prevents the motor from running in clockwise direction;

2: Both directions, with this setting, the motor can run in both directions;

Par. No.	Name	Range	Unit	Default
P0-10	Speed Set Source Selection	0~5		2

Select set value source.

0: main set source, only the main set source is used;

1: Multi preset value with priority

For example, set P0-11 = 1 (A11 as main set source), P0-12 = 13 (Mulita preset value as additional set source), P2-07 = 22, P2-08 = 23, P2-09 = 24, If DI1 is valid and DI2 and DI3 are invalid, the set value is P0-31. If DI1~DI3 are all invalid, the set value is corresponding to the value of A11. Note that P0-30 cannot have the priority.

2: Calculation of main set source and additional set source.

3: Switchover between main set source and additional set source.

The set source can be switched by the digital input terminal function (one of the parameters from P2-05 to P2-10 set to 41). When the corresponding terminal is invalid, the main set source is selected; when the terminal is valid, the additional set source is selected.

4: Switchover between main set source and the calculation of main set source and additional set source

5: Switchover between additional set source and the calculation of main set source and additional set source

Selecting 4 or 5 works similar as selecting 3.

Par. No.	Name	Range	Unit	Default
P0-11	Main Set Source	0~30		1
P0-12	Additional Set Source	Same as P0-11		20

Select the source for main set and additional set.

0: No function;

1: Terminal A11, use analogue input A11 as set source, refer to P3-00~P3-17;

2: Terminal A12, use analogue input A11 as set source, refer to P3-00~P3-17;

5: Pulse input, use pulse input as set source, refer to P2-50~P2-53;

10: Multi preset value 0 + Up/Down, use preset set value 0 plus Up/Down adjustment as set source, refer to P0-30~P0-37, P0-46 and P2-05;

11: Multi preset values, refer to ever to P0-30~P0-37 and P2-05;

20: Communication, use value from bus compunction;

21: Process PID, use the output of Process PID control as set source;

30: Keypad, use the command for keypad as set resource, refer to P3-68~P3-69;

Par. No.	Name	Range	Unit	Default
P0-14	Set Value Calculation from Main and Additional Source	0: Main Set Source + Additional Set Source 1: Main Set Source - Additional Set Source 2: Maximal Value of Main and Additional Set Source 3: Minimal Value of Main and Additional Set Source		0

This parameter is used to set calculation of main and additional set source, the calculated results can be used for parameter P0-10 options [2], [4] and [5].

Based on Parameter P0-10, P0-11, P0-12, P0-14, the set value for speed mode can be calculated as below:

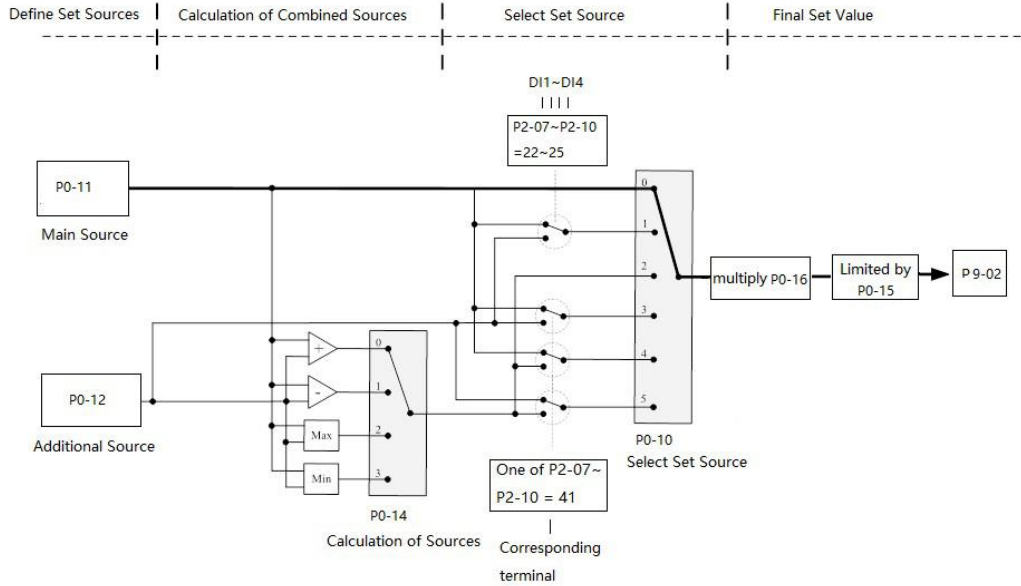

Par. No.	Name	Range	Unit	Default
P0-15	Speed Set Range	0: 0~P0-16 1: -P0-16~P0-16		0
P0-16	Base Value for Speed Set	0.0~400.0		50.0

These two parameters are used to control the range of the set value and used as percentage calculation base.

Par. No.	Name	Range	Unit	Default
P0-17	Control Site	0: Terminal or Bus Communication 1: Terminal 2: Bus Communication		0

The start, stop, reverse, jog commands can be given both through digital input terminals and communication, this parameter is used to select the drive control command site.

0: Terminal or Bus Communication, controlled by both digital input terminals and bus communication;

1: Terminal, controlled only by digital input terminals;

2: Communication only, controlled by bus communication only;

Par. No.	Name	Range	Unit	Default
P0-18	Selection of Communication Control Source	0: Null 1: Local RS485		1

Par. No.	Name	Range	Unit	Default
P0-30~P0-37	Multi Preset Values	-100.00~100.00	%	0.00

Different values preset in P0-30~P0-45 can be activated by different status of DI1 ~DI3 terminals (P2-07~P2-09 are set to [22] ~ [24])

For the relationship between active preset value and the status of DI terminals.

Preset Value Command Bit 3	Preset Value Command Bit 2	Preset Value Command Bit 1	Parameter selected
OFF	OFF	OFF	P0-30
OFF	OFF	ON	P0-31
OFF	ON	OFF	P0-32
OFF	ON	ON	P0-33
ON	OFF	OFF	P0-34
ON	OFF	ON	P0-35
ON	ON	OFF	P0-36
ON	ON	ON	P0-37

In speed control mode, 100% preset value is corresponding to P0-16. In torque control mode, 100% is corresponding to P1-08 rated motor torque.

Par. No.	Name	Range	Unit	Default
P0-46	UP/DOWN Step Value	0.01~50.00		0.10

To set the set value change step each time when a DI terminal valid. The corresponding terminal must be set with UP/DOWN function for UP/Down function (one of parameters from P2-05 to P2-10 set to [30] [31]). The UP/DOWN function is used when parameter P0-11 or P0-12 is

set to [10].

Par. No.	Name	Range	Unit	Default
P0-47	Save Up/Down Set Value	0: Not Save 1: Save when Stop 2: Save when Power Down		0

This parameter is used for setting whether to save the set value changed by Up/Down function if the drive stops or after it is powered down.

Par. No.	Name	Range	Unit	Default
P0-48	Jog Speed	0.0~400.0	Hz	5.0

The jog speed is a fixed output speed at which the drive is running when the jog function is activated by DI terminal.

Jog speed has the highest priority when a variety of commands are activated.

Par. No.	Name	Range	Unit	Default
P0-49	Ramp Time Resolution	0: 0.1s      1: 0.01s		1

There are two kinds of ramp time resolution for different applications.

After modifying this parameter, the ramp time defined in P0-51~P0-66 will be reset back to factory defaults.

Par. No.	Name	Range	Unit	Default
P0-50	Ramp 1 Type	0: Linear 1: S ramp		0
P0-51	Ramp 1 Ramp Up Time	0.05~655.35	s	*
P0-52	Ramp 1 Ramp Down Time	0.05~655.35	s	*
P0-53	Ramp 2 Type	0: Linear 1: S ramp		0
P0-54	Ramp 2 Ramp Up Time	0.05~655.35	s	*
P0-55	Ramp 2 Ramp Down Time	0.05~655.35	s	*
P0-56	Ramp 3 Type	0: Linear 1: S ramp		0
P0-57	Ramp 3 Ramp Up Time	0.05~655.35	s	*
P0-58	Ramp 3 Ramp Down Time	0.05~655.35	s	*
P0-59	Ramp 4 Type	0: Linear 1: S ramp		0
P0-60	Ramp 4 Ramp Up Time	0.05~655.35	s	*
P0-61	Ramp 4 Ramp Down Time	0.05~655.35	s	*
P0-62	Jog Ramp Time	0.05~655.35	s	*
P0-63	S Ramp Up Initiate Period	0.05~655.35	s	*
P0-64	S Ramp Up Termination Period	0.05~655.35	s	*
P0-65	S Ramp Down Initiate Period	0.05~655.35	s	*
P0-66	S Ramp Down Termination Period	0.05~655.35	s	*

Ramp Up Time: The total ramp time from 0Hz to rated motor frequency (P1-05)

Ramp Down Time: The total ramp time from rated motor frequency (P1-05) to 0Hz.

Ramp Type:

0: Linear, motor ramps up/down with constant acceleration/deceleration speed;

2: S ramp, motor ramps up/down with changing acceleration/deceleration speed to get a smooth speed change. Normally the changing speed of acceleration/deceleration speed is constant.

The ramp times and ramp types are shown below:

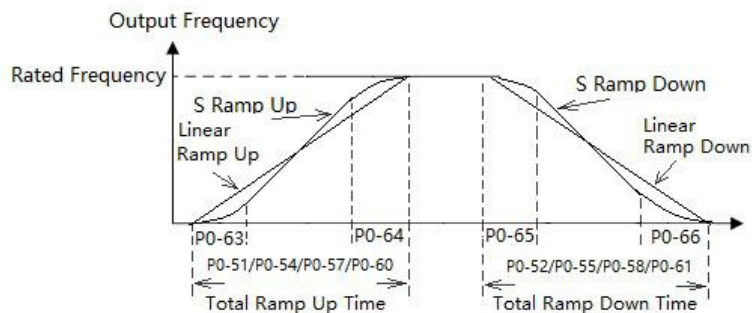

F or S ramp, P0-63 plus P0-64 should not be more than the total ramp up time defined by P0-51/P0-54/P0-57/P0-60, P0-65 plus P0-66 should not be more than the total ramp down time defined by P0-52/P0-55/P0-58/P0-61.

Par. No.	Name	Range	Unit	Default
P0-80	Local Address	1~127		1

Select the address for the bus communication.

Par. No.	Name	Range	Unit	Default
P0-81	Baud Rate	0: 2400 1: 4800 2: 9600 3: 19200 4: 38400 5~9: Reserved		2

Select baud rate for bus communication.

Par. No.	Name	Range	Unit	Default
P0-82	Communication Data Format (Parity/Stop Bits)	0: Even parity (1 stop bit) 1: Odd parity (1 stop bit) 2: No parity (1 stop bit) 3: No parity (2 stop bit)		0

Par. No.	Name	Range	Unit	Default
P0-83	Min. Communication Response Delay	0.000~0.500	s	0.002

Specify the minimum delay time between receiving a request and transmitting a response. This is used for overcoming modem turnaround delays.

Par. No.	Name	Range	Unit	Default
P0-84	Max. Communication Response Delay	0.010~10.000	s	5.000

Specify the maximum permissible delay time between transmitting a request and receiving a response. If the delay time exceeds this value, the drive will not respond to received data.

Par. No.	Name	Range	Unit	Default
P0-85	Message Response	0: Normal Responses 1: Only Response Exceptional Message 2: Not Response		0

This parameter is used to control Modbus message response.

Attention: the drive will response to the READ command and not response to the RADIO message no matter what P0-85 set.

Par. No.	Name	Range	Unit	Default
P0-86	Parameter (Set by Communication) Saving at Power Down	0: Not Save Parameter at Power Down 1: Save Parameter at Power Down		0

This parameter is used to control whether the parameters which is changed by communication WRITE command should be saved at power down.

Par. No.	Name	Range	Unit	Default
P0-88	Communication Timeout Time	0.01~650.00	s	1.00

If the time between two successful reception of telegrams exceeds this parameter, it indicates that the communication has stopped or failed, then the function set in P0-89 (Communication Timeout Function) will be activated. If this parameter is set to 0, then the timeout function defined in P0-89 is disabled.

Note: The time-out counter is triggered ONLY by a valid communication, so if the product never received any successful telegrams from power on, it will never trigger timeout function.

Par. No.	Name	Range	Unit	Default
P0-89	Communication Timeout Response Function	0: No Function 2: Stop Motor 3: Jogging 4: Run with Max Frequency P5-03 5: Trip to stop and Alarm Fault 6: Warning		0

The communication time-out function is activated if the product fails to receive successful telegram within the time period specified in P0-88 Communication Timeout Time.

0: No function, no response, control with the latest received control word.

2: Stop, overruled to stop;

3: Jogging, overruled to jog speed running;



4: Max. speed, overruled to max. speed running;

5: Trip to stop and alarm fault, trip to stop and alarm fault “A.62”.

6: Warning, warning with “u.62” and control with the latest received control word

Par. No.	Name	Range	Unit	Default
P0-90	Reset Communication Timeout	0: No Action 1: Reset the Timeout		0

The Communication Timeout flag can only be reset by this parameter. If the flag is not reset, even communication recovers and the alarm is cleared, the drive will continue to report communication timeout.

### 3.3.2 Group 1 Basics for Inverter and Motor Control

Par. No.	Name	Range	Unit	Default
P1-00	Switching Frequency	2~16: 2~16 kHz		*

Switching frequency has a significant influence to the drive and the motor. Select appropriate switch frequency can help to adjust acoustic noise from the motor, output harmonics, temperature of motor, the drive efficiency, as well as the EMC noise.

Par. No.	Name	Range	Unit	Default
*P1-01	Grid Type	2~122		*

Selects the grid type. Output frequency and voltage will be changed according to the grid type.

2: 200-240V/50Hz

12: 380-440V/50Hz

22: 440-480V/50Hz

102: 220-240V/60Hz

112: 380-440V/60Hz

122: 440-480V/60Hz

Par. No.	Name	Range	Unit	Default
*P1-02	Motor Type	0: Induction Motor		0

This parameter is used to select the motor type.

Par. No.	Name	Range	Unit	Default
*P1-03	Rated Motor Power	Depends on motor data	kW	*
*P1-04	Rated Motor Voltage	50~1000	V	*
*P1-05	Rated Motor Frequency	20~400	Hz	*
*P1-06	Rated Motor Current	Depends on motor data	A	*
*P1-07	Rated Motor Speed	100~24000	rpm	*
*P1-08	Rated Motor Torque	0.1~6553.5	N·m	*

Set the parameters according to the motor nameplate no matter which control mode is adopted. Changing the value of P1-03 and P1-04 will automatically reset the parameters P1-14 ~ P1-23 to factory defaults

Par. No.	Name	Range	Unit	Default
*P1-13	Auto Tuning for Motor Parameters	0: No Function 1: Simple Static Motor Auto Tuning 2: Complete Static Motor Auto Tuning		0

Use Automatic Motor Adaption (AMA) to obtain accurate motor parameters to further optimize control performance.

Please be noticed that, BEMF and Inertia tuning need to rotate the motor (no need to disconnect the load) and tuning for other parameters can run without rotating the motor. BEMF and Inertia tuning only work for PM motor. Simple static tuning only works for the stator resistor.

Before running the motor parameter auto tuning function, below motor parameters should be set correctly based on the motor nameplate: P1-03

Rated Motor Power, P1-04 Rated Motor Voltage, P1-05 Rated Motor Frequency, P1-06 Rated Motor Current, P1-07 Rated Motor Speed.

Par. No.	Name	Range	Unit	Default
*P1-14	Stator Resistance (Rs)	Depends on motor model	$\Omega$	*
*P1-15	Rotor Resistance (Rr)	Depends on motor model	$\Omega$	*
*P1-16	Stator Leakage Reactance (X1)	Depends on motor model	$\Omega$	*
*P1-17	Main Reactance (Xh)	Depends on motor model	$\Omega$	*

Normally you cannot get these values from the motor nameplate, you need to run the motor parameter auto tuning function or ask them from the motor supplier. If you failed to do both, then the factory defaults will be used for control which cannot be used to achieve the proper performance.

Par. No.	Name	Range	Unit	Default
*P1-24	Number of Motor Poles	2~100	P	4

Par. No.	Name	Range	Unit	Default
*P1-26	Motor Cable Length	0~150	m	10

Enter the motor cable length connected between the motor and the drive. Set correct cable length can suppress noises resulted from the motor.

Par. No.	Name	Range	Unit	Default
P1-32	Load Compensation Gain for Low Speed	0~199	%	100
P1-33	Load Compensation Gain for High Speed	0~199	%	100

Enter the % value to compensate voltage in relation to load when the motor is running at low speed (P1-32)/high speed (P1-33) and obtain the optimum load characteristic.

The low and high-speed change-over point is automatically calculated based on motor size. Usually it is 5Hz.

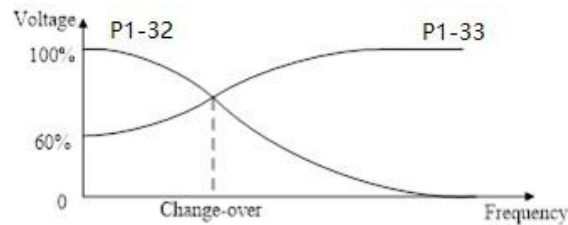

Par. No.	Name	Range	Unit	Default
P1-34	Motor Magnet Current at 0 Speed	0~300	%	100
P1-35	Cut in Speed for Normal Magnet Current	0.0~10.0	Hz	0.0

Use P1-34 Motor Magnet Current at 0 Speed along with P1-35 Cut in speed for Normal Magnet Current to obtain different thermal load and shaft performance on the motor when running at low speed (under P1-35). If the setting is too low, the torque on the motor shaft may be reduced.

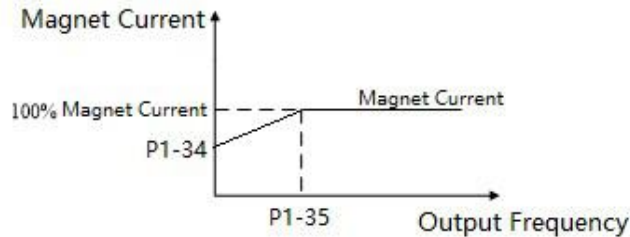

Par. No.	Name	Range	Unit	Default
P1-37	Slip Compensation Gain	-400~399	%	*

When the motor is running at a motoring state, motor speed drops with the increase of load. When the motor is running at a generating state, motor speed will increase with the increase of load. Appropriate slip compensation can maintain constant motor speed when the motor load is changing.

If this parameter is set to 100%, it indicates that the compensation when the motor bears rated load is the rated motor slip.

Diagram of slip compensation is shown below:

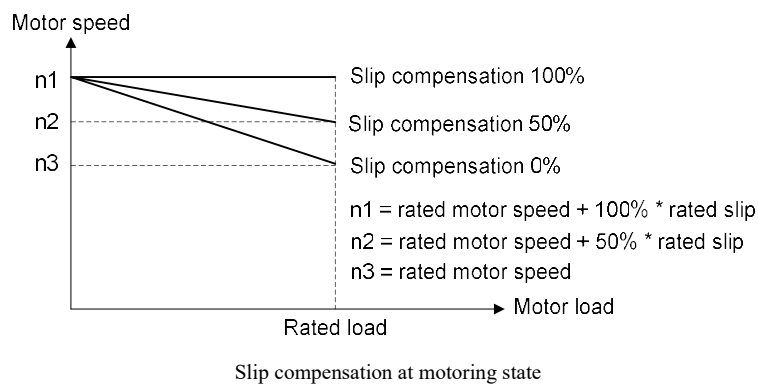

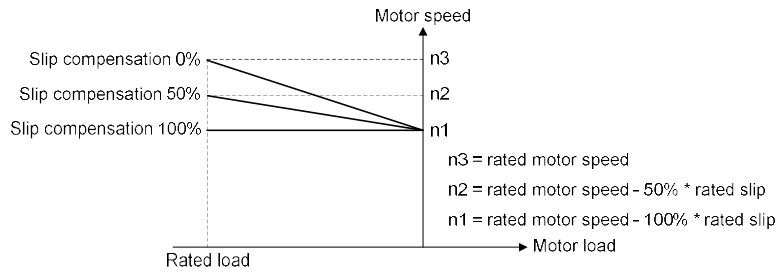

Slip compensation at generating state

When having more than one motor on the same shaft there is a need for some kinds of load sharing between the motors. This can be achieved by running motors in speed open loop and one with 0 or negative slip compensation, so called droop control.

Par. No.	Name	Range	Unit	Default
P1-38	Slip Compensation Time Constant	0.05~5.00	s	*

This parameter is to control the response speed of slip compensation, a higher value a slower reaction. If low frequency resonance problems occur, set it to a high value.

Par. No.	Name	Range	Unit	Default
P1-39	Resonance Damping Gain	0~3000	%	*
P1-40	Time Constant for Resonance Damping Filter	0.005~0.050	s	0.005

Motor (especially  $\geq 30\text{kW}$  motor) speed and current resonance is likely to occur due to load vibration, and may lead to system failure even trigger the over current protection. This is particularly obvious during no-load or light-load applications. Do not change these parameters if the motor has no resonance. Increase the P1-39 value properly only when the motor has obvious resonance. The larger the value is, the better the resonance dampening result will be. But a higher value in P1-39 will reduce the speed response performance. P1-40 should be set properly to ensure the damping function, a smaller value makes the response of damping function faster, but two small value can result in instability of the control.

Par. No.	Name	Range	Unit	Default
P1-53/P1-55/P1-57/P1-59/P1-61	Voltage for V/F curve	0.0~999.9	V	*
P1-54/P1-56/P1-58/P1-60/P1-62	Frequency for V/F curve	0.0~590.0	Hz	*

P1-53~P1-62 are used to define the VF curve to achieve the best load performance for a special motor. The curve is defined as below:

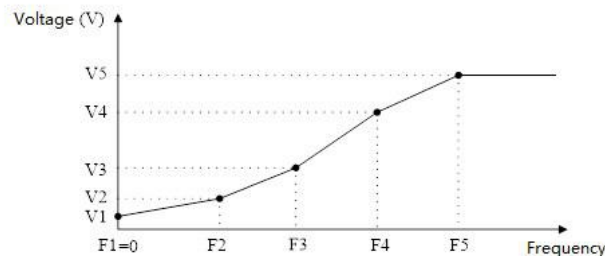

P1-53/P1-55/P1-57/P1-59/P1-61 corresponds to V1~V5 and P1-54/P1-56/P1-58/P1-60/P1-62 corresponds to F1~F5. Below rules must be followed for the set:  $F1=0$  and  $F1 \leq F2 \leq F3 \leq F4 \leq F5$ . If necessary, you can merge two or more points into one to simplify the VF curve, an example as below:

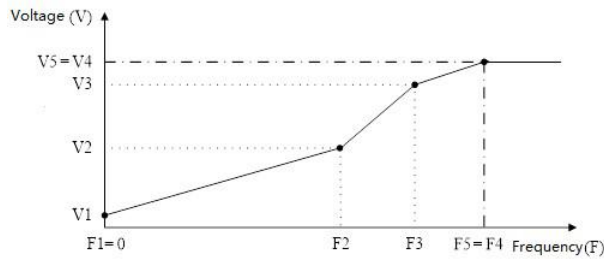

The default V/F curves are set as below.

220V Products:

Voltage	P1-53	P1-55	P1-57	P1-59	P1-61
	0.0	7.0	220.0	220.0	220.0
Frequency	P1-54	P1-56	P1-58	P1-60	P1-62
	0.0	0.5	50.0	50.0	50.0

380VProduct:

Voltage	P1-53	P1-55	P1-57	P1-59	P1-61
	0.0	12.0	380.0	380.0	380.0
Frequency	P1-54	P1-56	P1-58	P1-60	P1-62
	0.0	0.5	50.0	50.0	50.0

Note: The VF curve only work in VF control mode (P0.02=0). Two high voltage at low frequency could trigger the over current protection and damage the motor due to high current and temperature.

Par. No.	Name	Range	Unit	Default
*P1-64	IM Start Method	0: Direct Start 1: Fly start		0

If the IM motor is rotating, it cannot be controlled from 0Hz directly. Doing so will result in very high current damaging the product or fail to start. Enabling the fly start function (P1-64=1), the product will track the motor speed first and start with the speed tracked. If no rotating motor is found, the product will assume the motor is standstill and start the motor from 0 Hz.

When flying start is enabled, P1-70 Delay Time at Start and P1-71 Delay Function at Start is disabled.

Par. No.	Name	Range	Unit	Default
P1-67	Min Valid Speed Set	0.00~50.00	Hz	0.00

Only when the absolute value of the set speed is not less than P1-67, the product can be started. If a speed set of absolute value less than P1-67 is given, the product will treat it as a stop command and 0Hz speed set.

Note: The product will ramp through the Min Valid Speed Set range still if a valid speed set is given, e.g., if 20Hz is set and P1-67 = 5.0, the product will ramp from 0Hz, through 1Hz, 2Hz ... 5Hz to 20Hz.

Par. No.	Name	Range	Unit	Default
P1-68	Bypass Range for IM Low Speed	0.0~20.0	Hz	0.0

If the set speed's absolute value is less than P1-68, the drive will run at the frequency defined P1-68. If the set speed's absolute value is higher than P1-68, the product will start from P1-68 directly and then ramp to the set speed. Please be noted that P1-68 only control the absolute value of the speed command, it will not change the motor direction. For example:

Set P1-68 = 3. if the set speed is 2, the product will run forward at 3Hz; If the set speed is -2, the product will run reverse at 3Hz. If the set speed is 20, the product will run at 3Hz immediately, then accelerates from 3Hz to 20Hz using ramp time. If the set speed change from 20Hz to -20Hz, the product will ramp down to 3Hz first, then jump to -3Hz immediately and ramp to -20Hz. If the frequency reference is 0, the drive will ramp down to 3Hz first and stop directly from 3Hz.

Note:

1. It is not recommended for using P1-67 and P1-68 together.
2. If both P1-68 and P1-84 are enabled (higher than 0), DC brake will only be active when P1-84 > P1-68.

Par. No.	Name	Range	Unit	Default
P1-70	Delay Time at Start	0.0~10.0	s	0.0
P1-71	Delay Function at Start	0: Free Coast 1: DC Hold		0

P1-70 enables a delay time from receiving the start command given to starting the motor. The drive begins with the start function selected in

P1-71 during the P1-70 delay time first then start the motor. Setting the delay time to 0.0 disables P1-71 delay function. P1-71 delay function is described as below:

0: Coast, Motor coasts during the start delay time (drive off);

1: DC Hold, energizes motor with a DC holding current (P1-72 DC Hold Current) during the start delay time;

Note: 1. The P1-70 Delay Time will not be included in the ramp up time.

2. When fly start is enabled (P1-64=1), the P1-71 Delay function will be disabled.

Par. No.	Name	Range	Unit	Default
P1-72	DC Hold Current	0~150	%	50

Enter a value for holding current as a percentage of the rated motor current set in P1-06 Rated Motor Current. Customer can use this parameter to either hold the motor (holding torque) or pre-heat the motor. This parameter is active if DC Hold has been selected in either P1-71 or P1-80. The difference is that, for P1-71 delay function as start, the DC hold current will only continue during P1-70 delay time, but for P1-80 Hold Function at Stop, the DC hold current will continue at stop until a start command is given.

Par. No.	Name	Range	Unit	Default
P1-80	Function at Stop	0: Free Coast 1: DC hold		0
P1-81	Cut in Speed for Function at Stop	0.0~400.0	Hz	0.0

P1-80 Selects the function when stop command is given and the speed is ramped down to P1-81 Cut in Speed for Function at Stop.

0: Free Coast, disable the output of the product and the motor coasts;

1: DC hold, the motor is energized with a DC current as P1-72 DC Hold Current;

Diagram of Function at Stop is shown below:

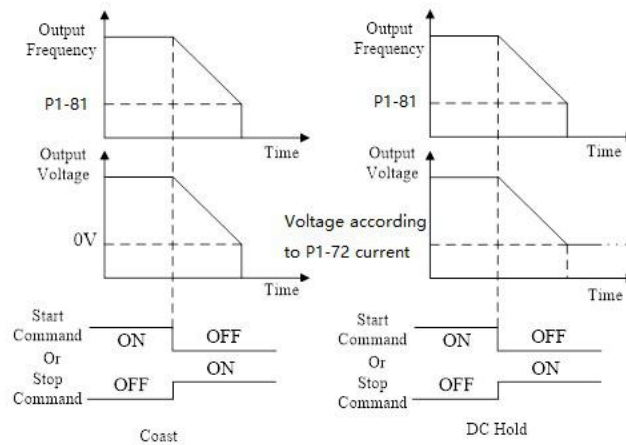

Note: If P1-81 > P1-84, the P1-80 function at stop will work and the DC brake function will not; if P1-81 < P1-84, the DC brake function will work. And the P1-80 function at stop will not.

Par. No.	Name	Range	Unit	Default
P1-82	DC Brake Current (IM)	0~150	%	50
P1-83	DC Brake Time (IM)	0.0~60.0	s	2
P1-84	DC Brake Cut in Speed (IM)	0.0~400.0	Hz	0.0
P1-85	Demagnetizing Rate at DC Cut in	0~100	%	100

DC brake is to apply a DC current on the motor to brake and hold the motor when motor speed ramps down to a low speed at stop command. P1-82 defines the DC brake current as a percentage of P1-06 Rated Motor Current. P1-83 defines how long time the DC current should be applied. P1-84 defines at which speed to start the DC brake current. Between normal ramp down and the DC brake current applied, a Demagnetizing period is necessary to avoid possible current spikes. P1-85 defines how fast the demagnetizing period will finished. Higher P1-85 value needs longer time for demagnetizing, means more time delay before the DC brake current is applied.

Diagram of DC Brake process is shown below:

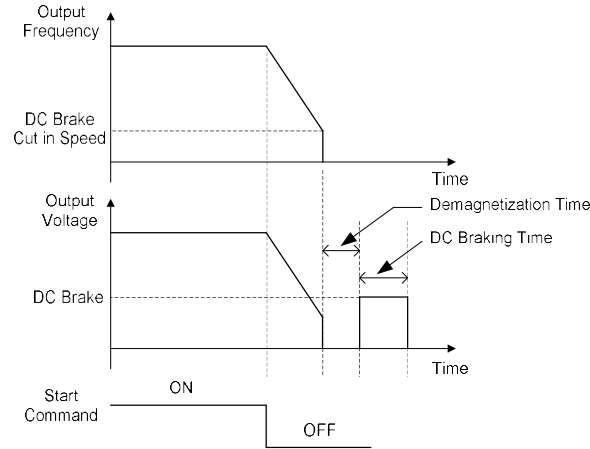

Note: P1-85 also works for P1-80.

Par. No.	Name	Range	Unit	Default
P1-91	Brake Function	0: No Function 1: Resistor Brake 2: AC Brake		0

0: No function;

1: Resistor brake, use the resistor to consume surplus energy resulting from motor braking, and prevent the drive from trip due to over-voltage in the DC link;

2: AC brake, dissipate surplus energy in the motor core by applying higher voltage to the motor, and prevent the drive from trip due to over-voltage in the DC link. It is important to keep in mind that frequent use of this function will cause an increase in motor temperature;

Par. No.	Name	Range	Unit	Default
P1-92	Max AC Brake Current	0~150	%	100

Defines the maximum permissible current when using AC brake to avoid overheating of motor windings. 100% equals motor current set in P1-06.

Par. No.	Name	Range	Unit	Default
P1-93	AC Brake Gain	1.0~2.0		1.4

Enter AC brake reaction speed. A high value results in faster reaction.

Par. No.	Name	Range	Unit	Default
P1-94	Threshold Voltage for Brake Function	Grid Dependent	V	*

If P1-91 is set to 1, When the DC link voltage exceeds the value of P1-94, resistor brake starts to function and the energy will be rapidly consumed through brake resistor, if the DC link voltage drops back lower than P1-94, the resistor brake function stops.

The following table is the Resistor Brake Threshold Voltage's range and default value which depends on P1-01 Grid Type:

Grid Type	Set Range	Factory Defaults
200~240V	360~395V	385V
380~440V	680~780V	700V
440~480V	750~780V	770V

Par. No.	Name	Range	Unit	Default
P1-95	Resistor Brake Resistance	5~65535	$\Omega$	*

Defines the resistance of the brake resistor.

### 3.2.3 Parameter Group 2: Digital Terminal Functions

Par. No.	Name	Range	Unit	Default
P2-00	DI Positive-Negative Logic Selection	0~65535		0
P2-02	DI Input Mode	0: NPN Input 1: PNP Input		0

P2-00 is used to control the digital input terminal positive or negative logic. Each digital input terminal corresponds to a weight. For example: if you want to set FWD and DI2 terminal as negative logic, set the P2-00 to

$$1 + 8 = 9$$

Terminal Weight	DI4	DI3	DI2	DI1	FEV	FWD
	32	16	8	4	2	1

P2-02 is used to select DI input mode. In NPN Mode, when the digital input selects positive logic, connecting the digital input terminal and GND terminal is ON state (active), disconnecting is OFF state (inactive); When the digital input selects negative logic, connecting the digital input terminal and GND terminal is OFF state (inactive), disconnecting is ON state (active). In PNP Mode, on the contrary.

Note: There are some digital input function is inverse. If the terminal logic is set as negative and the function of the terminal is inverse, then the function of the terminal is positive. For example: When P2-05 Terminal RUN is set to [4] Stop inverse, P2-00 is set to 1 (The logic of terminal RUN is negative), then connect the terminal RUN and GND, function "stop" is active, disconnect the terminal RUN and GND, function "stop" is inactive.

Par. No.	Name	Range	Unit	Default
P2-01	DO/Relay Positive-Negative Logic Selection	0~65535		0

This parameter is used to control the DO/Relay terminal positive or negative logic. Each DO/Relay terminal corresponds to weight. For example: If you want to set DO1 and Relay2 terminal as negative logic, set the P2-01 to  $1 + 4 = 5$

Terminal Weight	Relay2	Relay1	DO1
	4	2	1

Positive logic: When the selected function of DO/Relay terminals is activated, the DO/Relay terminal outputs ON signal, else outputs OFF signal.

Negative logic: When the selected function of DO/Relay terminals is activated, the DO/Relay terminal outputs OFF signal, else outputs ON signal.

Par. No.	Name	Range	Unit	Default
P2-04	DI Filter Time	2~16	ms	4

It is used to set the software filter time of DI terminal status. If DI terminals are liable to interference and may cause malfunction, increase the value of this parameter to enhance the anti-interference capability. However, increase of DI filter time will reduce the response of DI terminals.

Par. No.	Name	Range	Unit	Default
P2-05	FWD Input Function Selection	0~51		10
P2-06	REV Input Function Selection	Same as P2-05		12
P2-07	DI Function Selection - Terminal D1	Same as P2-05		22
P2-08	DI Function Selection - Terminal D2	Same as P2-05		23
P2-09	DI Function Selection - Terminal D3	Same as P2-05		24

The parameters are used for selecting various functions in the drive. All digital inputs can be set to the following functions:

0: No function, no reaction to signals transmitted to the terminal;

1: Reset, reset the drive after a Trip/Alarm;

2: Coast to Stop (Negative Logic), disables output, leaving the motor coasting to stop. Terminal logic '0' => coasting stop;

3: Coast to Stop and Reset (Negative Logic), the drive resets leaving the motor coasting to stop. Terminal logic '0' => coasting stop;

4: Stop (Negative Logic), the drive stops according to selected ramp time. Terminal logic '0' => stop;

10: Run, run with a start a start/stop command. Terminal logic '1' = start, logic '0' = stop;

11: Forward/Reverse Selection, select the direction of motor shaft rotation. when start signal and running direction selection signal are active, the motor will start reverse; when start signal is active and running direction selection signal is inactive, the motor will start forward; when start signal is inactive, the motor will stop;

12: Run in Reverse Direction, start with a reverse direction;

13: Latched run forward, run the motor in forward direction with a start command if a valid signal is applied for min. 4ms(signal from OFF to ON, and keep ON state at least 4MS ). The motor stops when [4] Stop (Negative Logic) or [17] Latched stop is activated;

14: Latched run reverse, run the motor in reverse direction with a start command if a valid signal is applied for min. 4ms(signal from OFF to ON, and keep ON state at least 4MS ). The motor stops when [4] Stop (Negative Logic) or [17] Latched stop is activated;

15: Forward Jog, used for start in forward direction with jog speed, see P0-48;

16: Reverse Jog, used for start in reverse direction with jog speed, see P0-48;

17:Latched stop, the motor will stop when a valid is applied for min. 4ms(signal from OFF to ON, and keep ON state at least 4MS ).this function

usually cooperate with [13] latched run forward or [14] latched run reverse.

20: Forbid Forward, when this signal is active, start forward will be forbidden, but start reverse will be allowed;

21: Forbid Reverse, when this signal is active, start reverse will be forbidden, but start forward will be allowed;

22: Preset Value Command Bit 1, Preset Value Command Bit 1, bit2, bit3 enable a choice between one of the eight multi preset values (see P0-30~P0-37) according to the table below;

23: Preset Value Command Bit 2, same as [22];

24: Preset Value Command Bit 3, same as [22];

Preset Value Command Bit 3	Preset Value Command Bit 2	Preset Value Command Bit 1	Parameter selected
OFF	OFF	OFF	P0-30
OFF	OFF	ON	P0-31
OFF	ON	OFF	P0-32
OFF	ON	ON	P0-33
ON	OFF	OFF	P0-34
ON	OFF	ON	P0-35
ON	ON	OFF	P0-36
ON	ON	ON	P0-37

26: Ramp Time Selection Bit 1;

27: Ramp Time Selection Bit 2; ramp bit1, bit2 are used for selecting one of the four ramps;

Terminal of Ramp bit2	Terminal of Ramp bit1	Parameters selected
OFF	OFF	Ramp1 (P0-51, P0-52)
OFF	ON	Ramp2 (P0-54 P0-55)
ON	OFF	Ramp3 (P0-57, P0-58)
ON	ON	Ramp4 (P0-60, P0-61)

30: Speed Up, when the terminal is activated for less than 400 ms. the resulting reference will be increased by P0-46 Up/Down Value. If the terminal is activated for more than 400 ms, the resulting reference will ramp according to ramp 4 P0-60;

31: Speed Down, like [30] Up;

32: Counter A, to count the pulse number inputted into the terminal;

34: Reset counter A, to clear counter A to “0”;

35: Counter B, like [32] Counter A;

37: Reset counter B, to clear counter B to “0”;

40: Pulse input, select pulse input when using a pulse sequence as either reference or feedback. Scaling is done in par. group P2-5\*, the function is available for P2-10 Terminal DI4 only;

41: Switch Set Source, this function is used P0-10 Reference Source Selection option [3]-[5].

42: Switch Speed Mode/Torque Mode, when P0-01 Configuration Mode is set to [2] Torque open loop, torque open loop and speed open loop can be switched via digital input terminal. The terminal is in the OFF state, it is torque open loop; The terminal is in the ON state, it is speed open loop;

50: External Fault Input, when terminal is in ON state, the drive will run as P2-21 specified.

51: Freeze PID output, the Process PID is temporarily stopped and the drive maintains the current frequency.

Par. No.	Name	Range	Unit	Default
P2-21	Action for DI as External Fault Input	0~6		0

The parameter is used for selecting actions when External alarm input is in ON state.

0: No action;

2: stop and warning, when External alarm input is in ON state, Drive will stop and report warning “u.76”;

3: Jog and warning, when External alarm input is in ON state, Drive will run in Jog speed and report warning “u.76”;

4: Running in Max speed and warning, when External alarm input is in ON state, Drive will run in Maximum speed and report warning “u.76”;

5: Alarm Fault and Trip to stop, when External alarm input is in ON state, Drive will report alarm “A.76” and trip to stop;

6: Only warning, when External alarm input is in ON state, Drive will report warning “u.76”;

Par. No.	Name	Range	Unit	Default
P2-28	Relay Output Function Selection	0~44		10



Set the function which will trigger the Terminal DO1 output.

Terminal DO1 is a programmable multiplex terminal, it can be a high-speed pulse output terminal, also available as a collector's digital output terminal. If P2-60 = 0, DO1 is as a collector's digital output terminal; If P2-60 is not set to 0, DO1 is as a high-speed pulse output terminal.

If terminal DO1 is as collector's digital output terminals, their output function options are the same as relay output P2-28/P2-31.

0: No operation;

1: Drive ready, the drive control card has received supply voltage;

2: Remote control ready, the drive is ready and is in Remote mode;

3: Drive ready/stop, the drive is ready and the drive is not running;

4: Drive running, the drive is running;

5: Drive running/No warning, the drive is running and no warning is present;

6: Run in current range/No warning, the drive is running within the programmed current ranges set in P5-09 and P5-10. No warnings are present;

7: Run on reference/No warning, the drive runs at reference speed without warnings;

8: Reverse, the drive runs in counter clockwise;

10: Alarm, the drive alarms;

11: Alarm or warning, an alarm or warning occurs;

12: Thermal warning, a thermal warning occurs;

13: Ready, no thermal warning, the drive is ready for operation and no over-temperature warning is present;

14: Remote ready, no thermal warning, the drive is ready for operation in Remote mode, and no over-temperature warning is present;

15: Bus OK, local bus communication is normal;

20: Out of current range, output current is outside the range set in P5-09 and P5-10;

21: Below current low, output current is lower than set in P5-09;

22: Above current high, output current is higher than set in P5-10;

23: Out of frequency range, output frequency is outside the range set in P5-11 and P5-12;

24: Below frequency low, output frequency is lower than set in P5-11;

25: Above frequency high, output frequency is higher than set in P5-12;

26: Out of feedback range, feedback is outside the range set in P5-15 and P5-16;

27: Below feedback low, feedback is lower than set in P5-15;

28: Above feedback high, feedback is higher than set in P5-16;

29: Out of reference range, reference is outside the range set in P5-13 and P5-14;

30: Below reference low, reference is lower than set in P5-13;

31: Above reference high, reference is higher than set in P5-14;

40: Drive in Local mode;

41: Drive in Remote mode;

42: Mech. brake control, enter mechanical brake control signal, see P1-97/P1-98;

43: External alarm, the digital input terminal function [50] external alarm input is active;

44: Unbalance warning, unbalance occurs;

Par. No.	Name	Range	Unit	Default
P2-29	Relay on Delay Time - RL1	0.00~600.00	s	0.00
P2-30	Relay off Delay Time - RL1	0.00~600.00	s	0.00

These parameters are used to set the relay output turn-on and turn-off delay time, E.g:

When the relay 1 function is satisfied, it delays P2-29 time, then outputs ON.

When the relay 1 function is not satisfied, it delays P2-30 time, then outputs OFF.

Par. No.	Name	Range	Unit	Default
P2-46	Save DI Counter Value at Power down	0: Save None 1: Save Counter A 2: Save Counter B 3: Save Both Counter A and B		0

This parameter is used to control whether counter A/B's value is saved at power down.

### 3.2.4 Parameter Group 3: Analogue Terminal Functions

Par. No.	Name	Range	Unit	Default
P3-00	Signal Type - Terminal A11	0: Analogue Voltage 1: Analogue Current		0

Select the signal type to be present on analog input A11.

0: voltage signal, 0 ~ 10V voltage input

1: Current signal, 0 ~ 20mA current input

Par. No.	Name	Range	Unit	Default
P3-01	Terminal A11 Filter Time	0.01~10.00	s	0.01

Enter the terminal A11 filter time. This is a first-order digital low pass filter for suppressing electrical noise in terminal A11. A high time constant value improves dampening but also increases the time delay through the filter.

Par. No.	Name	Range	Unit	Default
P3-02	Zero Voltage Dead Band - Terminal A11	0.0~20.00	V/mA	0.00

Set the dead-band of A11 at 0 speed. When analog input A11 ref. low and ref. high have opposite signs, there must be a set point that corresponding to an analogue value equals 0. In order to prevent the set point jitter at zero point due to analog interference, this parameter should be set properly.

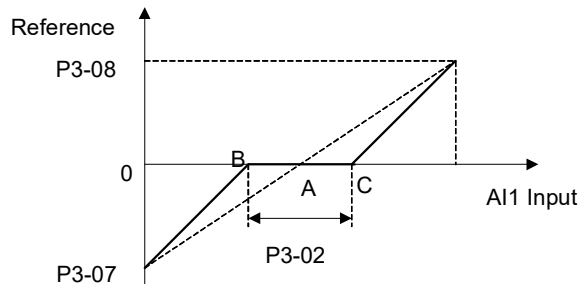

Point A as shown in the figure is the analog value that corresponds to a setpoint that equals 0. It is calculated via analog low, high values and low, high reference values. After set terminal A11 zero dead band,  $U_{AB}=U_{AC}=P3-02/2$ . If the A11 input is between B and C, the A11 reference is 0.

Par. No.	Name	Range	Unit	Default
P3-03	Min Input Voltage - Terminal A11	0.00~P3-04	V	0.00
P3-04	Max Input Voltage - Terminal A11	P3-03~10.00	V	10.00
P3-05	Min Input Current - Terminal A11	0.00~P3-06	mA	0.00
P3-06	Max Input Current - Terminal A11	P3-05~20.00	mA	20.00
P3-07	Set Value/Feedback Value Versus Min Input -Terminal A11	-200.00~200.00	%	0.00
P3-08	Set Value/Feedback Value Versus Max Input -Terminal A11	-200.00~200.00	%	100.00

P3-03 is used to set min voltage input; P3-05 is used to set min current input; The min voltage and current analog input corresponds to the set/feedback value set in P3-07.

P3-04 is used to set max voltage input; P3-06 is used to set max current input; The max voltage and current analog input corresponds to the set/feedback value set in P3-08.

There are 4 kinds of curves between terminal A11 input voltage/current and its corresponding set/feedback value:

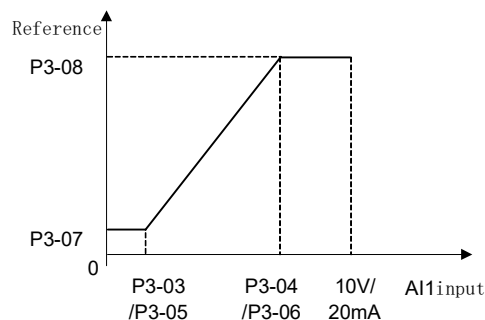

$$P3-07 < P3-08 \text{ and } P3-07 \geq 0$$

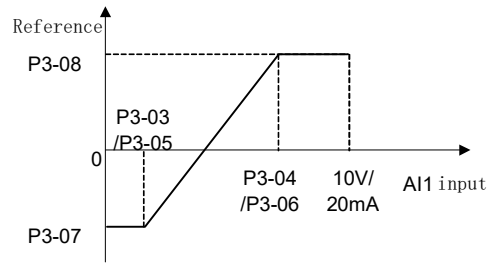

P3-07 < P3-08 and P3-07 < 0

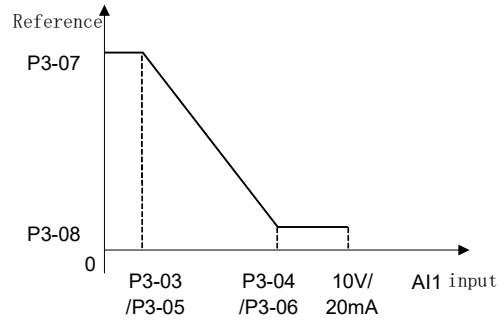

P3-07 > P3-08 and P3-08 >= 0

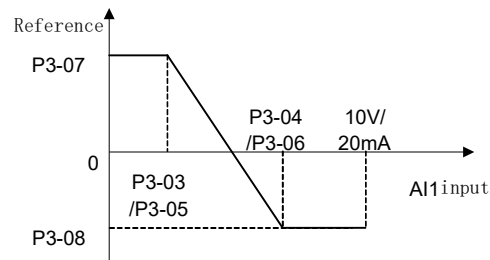

P3-07 > P3-08 and P3-08 < 0

Terminal AI1 set/feedback value calculated as follows:

If  $P3-03 \leq AI1 \text{ Input} \leq P3-04$ ,

AI1 set/feedback Value =  $((P3-08 - P3-07) \div (P3-04 - P3-03)) \times (AI1 \text{ input} - P3-03) + P3-07 \times P0-16$ ;

If  $AI1 \text{ Input} < P3-03$ , AI1 set/feedback Value =  $P3-07 \times P0-16$ ;

If  $AI1 \text{ Input} > P3-04$ , AI1 set/feedback Value =  $P3-08 \times P0-16$ ;

Note: Above formulas are for voltage input. If it is a current input, P3-03 and P3-04 use P3-05 and P3-06 instead respectively.

Par. No.	Name	Range	Unit	Default
P3-09	Signal Type - Terminal AI2	0: Analogue Voltage 1: Analogue Current		1
P3-10	Terminal AI2 Filter Time	0.01~10.00	s	0.01
P3-11	Zero Voltage Dead Band - Terminal AI2	0.0~20.00	V/mA	0.00
P3-12	Min Input Voltage - Terminal AI2	0.00~P3-13	V	0.00
P3-13	Max Input Voltage - Terminal AI2	P3-12~10.00	V	10.00
P3-14	Min Input Current - Terminal AI2	P3-15~19.99	mA	0.00
P3-15	Max Input Current - Terminal AI2	P3-14~20.00	mA	20.00
P3-16	Set Value/Feedback Value Versus Min Input -Terminal AI2	-200.00~200.00	%	0.00
P3-17	Set Value/Feedback Value Versus Max Input -Terminal AI2	-200.00~200.00	%	100.00

The usage of terminal AI2 is like terminal AI1.

Par. No.	Name	Range	Unit	Default
P3-48	Analogue Live Zero Timeout Time	1~99	s	10

Live Zero Time-out Function is used for analog input signal detection. To active the Live Zero Timeout Function, if voltage input is selected, then the low input voltage (P3-03, P3-12) settings must be greater than 1V; if current input is selected, the low input current (P3-05, P3-14) settings must be greater than 2mA or more. If the analog input signal is lower than 50% of the settings of parameters of P3-03, P3-05, P3-12, P3-14, and lasts longer than the settings of P3-48 Live Zero Timeout Time, this feature takes effect.

If the analog input signal is back to normal within the delay time, then reset the timer.

Diagram of Live Zero Timeout Function is shown below:

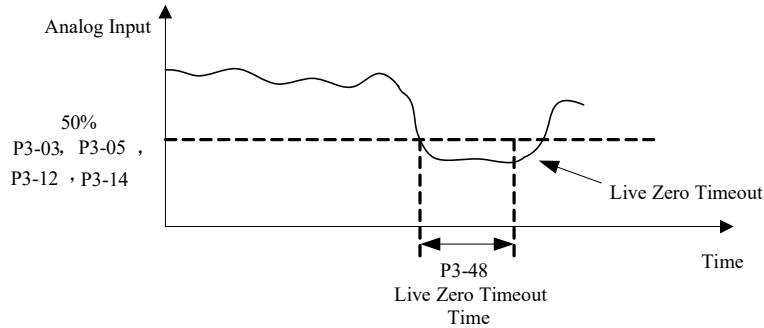

Par. No.	Name	Range	Unit	Default
P3-49	Live Zero Timeout Function	0: No Action 2: Stop and Warning 3: Jog and Warning 4: Run at Max Speed P5-03 and Warning 5: Alarm Fault and Trip to stop		0

Select the live zero time-out function.

- 0: No function;
- 2: Stop and warning, Drive stop and report warning “u.57”;
- 3: Jog and warning, Drive will run in Jog speed and report warning “u.57”;
- 4: Run at Max Speed P5-03 and Warning, Drive will run in P5-03 Maximum speed and report warning “u.57”;
- 5: Alarm Fault and Trip to stop, Drive will report alarm “A.57” and trip to stop.

Par. No.	Name	Range	Unit	Default
P3-50	Signal Type - Terminal AO1	0: 0-20mA 1: 4-20mA 3: 0-10V		3

Select the output signal type to be present on analog output AO1.

Par. No.	Name	Range	Unit	Default
P3-51	Output Function Selection- AO1	0~30		0

Select choices for the analog output AO1

Option	Function	Scale
0	No function	
1	Output frequency	In torque open loop: 0% = 0, 100% = P5-08 In speed open loop mode: 0% = 0, 100% = P0-16
2	Output current	0% = 0, 100% = P9-16
3	Output Power	0% = 0, 100% = P1-03
4	Motor Speed	0% = 0, 100% = P1-07
5	Output voltage	0% = 0, 100% = P1-04
10	Set Value	If P0-15 = 0, then 0% = 0, 100% = P0-16; If P0-15 = 1, then 0% = -P0-16, 100% = P0-16;
11	Feedback Value	
13	Set Value from Bus control	
14	Pulse input 1 input frequency	0% = P2-50, 100% = P2-51
15	Terminal AI1 input value	0% = P3-03 or P3-05, 100% = P3-04 or P3-06
16	Terminal AI2 input value	0% = P3-12 or P3-14, 100% = P3-13 or P3-15
20	DC link voltage	0% = 0V, 100% = 1000V

Par. No.	Name	Range	Unit	Default
P3-52	Value Versus Min Output - AO1	0.00~200.00	%	0.00
P3-53	Value Versus Max Output - AO1	0.00~200.00	%	100.00
P3-54	Min Output Voltage/Current - AO1	0.00~P3-55		0.00 /4.00
P3-55	Max Output Voltage/Current - AO1	P3-54~10.00/20.00		10.00 /20.00

Scale minimum/maximum output of selected analog signal at terminal AO1 as percentage of minimum/maximum signal value.

For example: In speed open loop mode, set P0-16 = 50.0, P3-50 = 3 (0~10V), P3-50 = 1 (Output frequency 0% = 0.0Hz, 100% = 50.0Hz), P3-52 = 0.00% (0.0Hz), P3-53 = 100.00% (50.0Hz), P3-54 = 2V, P3-55 = 8V, the relationship between the output frequency and AO1 output is shown below:

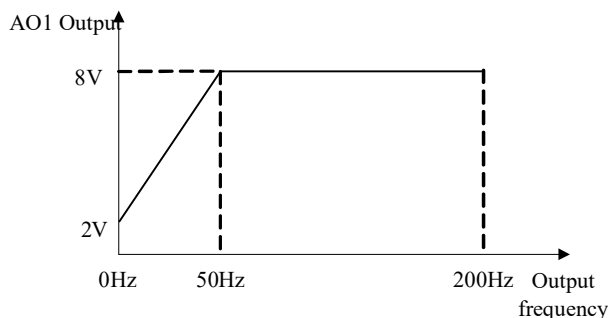

If P3-52 = 80.00% (40Hz), P3-53 = 10.00% (5Hz), then the relationship between the output frequency and AO1 output is shown below:

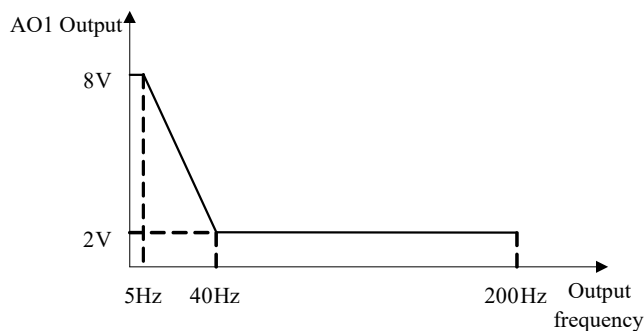

Par. No.	Name	Range	Unit	Default
P3-68	Min Set Value from Keypad	-200.00~200.00	%	0.00
P3-69	Max Set Value from Keypad	-200.00~200.00	%	100.00

These parameters are used to set the minimum/maximum set value from Keypad Up/Down key or potentiometer.

### 3.2.5 Parameter Group 4: Process PID and Other Controllers

Par. No.	Name	Range	Unit	Default
P4-00	Process PID Feedback Source	0: No function 1: Terminal AI1 2: Terminal AI2 20: Bus Communication		0

Select source of feedback signal.

Par. No.	Name	Range	Unit	Default
P4-01	Process PID Set Source	0: No function 1: Terminal AI1 2: Terminal AI2 5: Pulse input 1 10: Preset value 0+UP/DOWN 11: Multi preset value 20: Bus communication 30: Keypad		0

Select process PID reference source.

- 0: No function;
- 1: Terminal AI1, use analogy input AI1 as reference source, see P3-0\*;
- 2: Terminal AI2, use analogy input AI2 as reference source, see P3-1\*;
- 5: Pulse input 1, use pulse input DI4 as reference source, see P2-5\*;
- 10: Present value 0 + Up/Down, use present value 0 and Up/Down, see P0-30;
- 11: Multi present value, see P0-30~P0-45;
- 20: Bus communication, use bus reference as reference source;
- 30: Keypad, use Keypad Up/Down key or potentiometer as reference source, see P3-68/P3-69;

Par. No.	Name	Range	Unit	Default
P4-02	Fiducial Value for Process PID Set/Feedback	0.0~3000.0		50.0

This parameter is set as the fiducial value of 100% set or feedback for process PID control.

Par. No.	Name	Range	Unit	Default
P4-04	Process PID Control Logic: Positive/Negative	0: Positive; 1: Negative		0

- 0: Positive, reduce/increase the PID output if the feedback value is larger/lower than set value;
- 1: Negative, reduce/increase the PID output if the feedback value is lower/larger than set value;

Par. No.	Name	Range	Unit	Default
P4-05	Process PID Anti Windup	0: Disable; 1: Enable		0

In case the PID output has reaches the limit but the error between set value and feedback value still exists in same sign, if the integrator continues to work then the result of integrator will be very high. It will take very long time for the PID controller to response to the error sign change e.g. from positive to negative. This ruins the control performance in a lot of application. Customer can use this function to avoid the problem.

- 0: Disable, continue regulation of a given error even when the PID output reaches to its limit;
- 1: Enable, ceases regulation of a given error when the PID output reaches to its limit;

Par. No.	Name	Range	Unit	Default
P4-06	Cut-in Frequency for Process PID Speed Mode	0.0~200.0	Hz	0.0

Given a start command, the product will ramp from 0 to P4-06 in speed open control first. When the speed reaches to P4-06, the control will switch over to Process PID control. The principle is described as below:

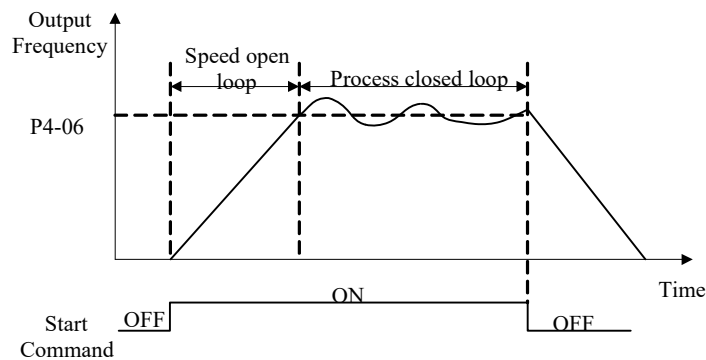

Par. No.	Name	Range	Unit	Default
P4-07	Proportional Gain - Process PID 1	0.00~10.00		0.01

Enter the PID proportional gain. The proportional gain multiplies the error between the set value and the feedback value.

Attention: This function is disabled when it is set to "0".

Par. No.	Name	Range	Unit	Default
P4-08	Integral Time - Process PID 1	0.01~655.35	s	655.35

Enter the PID integral time. The integrator provides an increasing gain at a constant error between the set value and the feedback value. The integral time is the time needed by the integrator to reach the same gain as the proportional gain.

Par. No.	Name	Range	Unit	Default
P4-09	Differentiating Time - Process PID 1	0.00~10.00	s	0.00

Enter the PID differentiation time. The differentiator does not react to a constant error, but provides a gain only when the error changes. The shorter the PID differentiation time, the stronger the gain from the differentiator.

Par. No.	Name	Range	Unit	Default
P4-13	Process PID Differential Limit	1.0~50.0		5.0

Enter a limit for the differentiator output.

Par. No.	Name	Range	Unit	Default
P4-14	Error Tolerance Limit to Enable Process PID	0.0~200.0	%	0.1

When the error between the set value and feedback value is less than the set value of this parameter, the process PID control stops. The way how PID control stops or restarts is controlled by P4-15.

Par. No.	Name	Range	Unit	Default
P4-15	Process PID Out/In Mode to Error Tolerance	0: Mode 0; 1: Mode 1; 2: Mode 2		0

0: Mode 0, if the absolute value of the error  $\geq$  P4-14, PID is enabled; if the absolute value of the deviation  $<$  P4-14, PID is disabled, PID output freezes;

1: Mode 1, if the absolute value of the error  $\geq$  P4-14, PID is enabled. If error  $>$  0, use error + P4-14 as error for PID calculation; If error  $<$  0, use error - P4-14 as error for PID calculation; if the absolute value of the error  $<$  P4-14, PID is enabled as normal;

2: Mode 2, if the absolute value of the error  $\geq$  P4-14, PID is enabled, but the output of I part is frozen; if the absolute value of the error  $<$  P4-14, PID is enabled as normal;

Par. No.	Name	Range	Unit	Default
P4-18	Process PID Output Low Limit	-100.00~100.00	%	0.00
P4-19	Process PID Output High Limit	-100.00~100.00	%	100.00

These parameters are used to set process PID controller output low/high limit, 100% corresponds to P5-03 in speed mode.

Par. No.	Name	Range	Unit	Default
P4-22	Process PID Integral Output Low Limit	-100.00~100.00	%	0.00
P4-23	Process PID Integral Output High Limit	-100.00~100.00	%	100.00

This group of parameters are used to set the process PID controller integral output high and low limits.

Par. No.	Name	Range	Unit	Default
P4-30	Speed PID Proportional Gain	0.000~1.000		0.010
P4-31	Speed PID Integral Time	2.0~2000.0	ms	8.0
P4-32	Speed PID Differentiation Time	0.0~200.0	s	30.0

Speed closed loop PID parameters.

Par. No.	Name	Range	Unit	Default
P4-52	Proportional Gain - Current Limit Controller	0~500	%	100
P4-53	Integration Time - Current Limit Controller	0.000~2.000	s	0.020
P4-54	Filter Time - Current Limit Control	0.1~100.0	ms	10.0

These parameters are used for the current limit controller which will be triggered if the motor current reaches to P5-07.

### 3.2.6 Parameter Group 5: Limitation, Protection and Failure Detection

Par. No.	Name	Range	Unit	Default
*P5-02	Motor Low Speed Limit	0.0~400.0	Hz	0.0
*P5-03	Motor High Speed Limit	0.0~400.0	Hz	65.0

P5-02 sets the low limit for Motor Speed. The Motor Low Speed Limit must not exceed the Motor Speed High Limit in P5-03. P5-03 sets the high limit for Motor Speed. The Motor High Speed Limit must exceed the Motor Low Speed Limit in P5-02. Please be noticed that, P5-02 and P5-03 are used to limit the set value.

Par. No.	Name	Range	Unit	Default
P5-07	Max Current Limit	0~300	%	*

This parameter is used to set the output current limit, 100% equals to P1-06 rated motor current. If the output current reaches the P5-07, the

product will report u.50 warning and current limit controllers start to function with the controller set in P4-5\*.

Par. No.	Name	Range	Unit	Default
*P5-08	Max Output Frequency Limit	0.0~400.0	Hz	65

Provides a final limit on the output frequency of the product. Please be aware of that this parameter limit the final stator frequency applied to the motor.

Par. No.	Name	Range	Unit	Default
P5-09	Threshold for Low Current Warning	0.00~P9-16	A	0.00
P5-10	Threshold for High Current Warning	0.00~ P9-16	A	*

When the motor current falls below P5-09 or exceeds P5-10, a signal can be produced on relays or terminal DO. See [20] Out of current range, [21] Below current low and [22] Above current high in P2-22/28/31.

Diagram of Warning Current Low and Warning Current High are shown below:

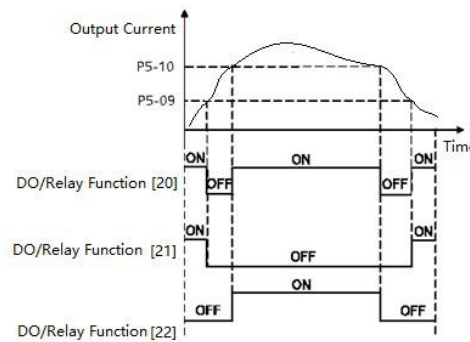

Par. No.	Name	Range	Unit	Default
P5-11	Threshold for Low Speed Warning	0.0~400.0	Hz	0.0
P5-12	Threshold for High Speed Warning	0.1~400.0	Hz	65.0

When the motor frequency falls below P5-11 or exceeds P5-12, a signal can be produced on relays or terminal DO. See [23] Out of frequency range, [24] Below frequency low and [25] Above frequency high in P2-22/28/31. Diagram of Warning Frequency Low and Warning Frequency High are shown below:

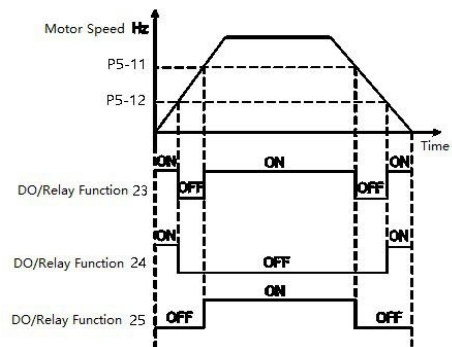

Par. No.	Name	Range	Unit	Default
P5-13	Threshold for Low Set Value Warning	-200.00~200.00	%	0.00
P5-14	Threshold for High Set Value Warning	-200.00~200.00	%	100.00

When the actual set value falls below P5-13 or exceeds P5-14, a signal can be produced on relays or terminal DO. 100% equals to value set in P0-16 in speed control mode, P1-08 in torque control mode. See functions [29], [30] and [31] in P2-20/31/40.

Note: These parameters work on the final set value decided by P0-11~P0-14, not on the set value for PID inputs.

Par. No.	Name	Range	Unit	Default
P5-15	Threshold for Low Feedback Warning	-200.00~200.00	%	0.00
P5-16	Threshold for High Feedback Warning	-200.00~200.00	%	100.00

When the feedback falls below P5-15 or exceeds P5-16, a signal can be produced on relays or terminal DO. 100% equals value set in P4-02. See function [26], [27] and [28] in P2-22/28/31.

Note: These parameters only work on the feedback for PID as selected by P4-00.



Par. No.	Name	Range	Unit	Default
*P5-17	Enable Motor Phase Loss Protection	0: Disable; 1: Enable		1

If select [0] disable the motor phase loss protection, in case there is the failure, the motor can only be possible to protect by over current protection. It may damage the motor and the customer get a wrong information. Normally it's not recommended to select [0]. But in case the product power size is much bigger than that of the motor and there is unbalance inside the motor, selecting [0] could avoid false alarm of motor phase loss.

Par. No.	Name	Range	Unit	Default
*P5-18	Enable Current Limit/Torque Limit Warning	0: Disable; 1: Enable		1

This parameter is used to control whether the drive reports u.50/u.51 warning or not when the motor torque exceeds P5-04/P5-05 or the output current exceeds P5-07.

Note: Even if you select disable the warning, current limit/torque limit controller still works.

Par. No.	Name	Range	Unit	Default
P5-26	Motor Thermal Protection Function	0: No Function 1: ETR Warning 2: ETR Alarm Fault 3: ETR Warning for Self-cooled Motor 4: ETR Alarm Fault for Self-cooled Motor		0

The product can afford thermal protection function via a calculation (ETR = Electronic Terminal Relay) of the thermal load of the motor. The calculated thermal load is based on the motor current and motor speed according to the set in P5-27 and P5-28.

0: No function, there is no motor thermal protection;

1: ETR warning, if calculated thermal load exceeds the upper limit, the product reports warning.49

2: ETR alarm fault, if calculated thermal load exceeds the upper limit, the product reports alarm A.49 and trip to stop

3: ETR warning (Self-cooling mode)

4: ETR trip (Self-cooling mode)

[3] and [4] are similar as [1] and [2], but [3] and [4] are for motors without cooling fan. And the calculated thermal load increases faster, more sensitive to motor speed and it takes longer time to clear the calculated thermal load when the current of the motor drops.

Par. No.	Name	Range	Unit	Default
P5-28	Threshold for Motor Overload Protection	100~160	%	150

When ETR function is used, if motor current exceeds P1-06 rated motor current \* P5-28 Threshold for Motor Overload Protection for duration exceeding P5-27 motor overload protection time, the product will trigger motor overload warning or alarm as defined in P5-26.

Motor overload protection is based on an inverse time integral calculation. The relationship between overload current and protection time (corresponding to P5-27) is described as below:

Motor current percent	Protection time(corresponding to P5-27)	Motor current percent	Protection time(corresponding to P5-27)
P5-28+0%	100%	P5-28+30%	20%
P5-28+6%	50%	P5-28+36%	18%
P5-28+12%	33%	P5-28+42%	17%
P5-28+18%	29%	P5-28+48%	16%
P5-28+24%	21%	P5-28+54%	14%

The table above assumes the motor runs at rated speed, below is the table for correction factor according to the motor speed (the real protection time should be divided by the correction factor).

Motor Speed (percent of P1-05)	Correction Factor	Motor Speed (percent of P1-05)	Correction Factor
0-12.5%	2.1	100%-112.5%	1
12.5%-25%	2.1	112.5%-125%	1.05
25%-37.5%	1.67	125%-137.5%	1.12
37.5%-50%	1.45	137.5%-150%	1.2
50%-62.5%	1.31	150%-162.5%	1.31
62.5%-75%	1.2	162.5%-175%	1.45
75%-87.5%	1.12	175%-187.5%	1.67
87.5%-100%	1.05	187.5%-Max.	2.1

For example, set P5-27 = 10, P5-28 = 120%, run at rated frequency, current is 132% rated motor current, protection time is  $10 \times 33\% = 3.3$

minutes. If the operating frequency is 30Hz (60% of rated frequency), the protection time is  $3.3 \div 1.31 = 2.52$  minutes.

Note: It is necessary to correctly set the P5-28 motor overload protection factor according to the actual overload capacity of the motor. If this parameter is set too large, it may happen that the motor is overloaded but the product cannot protect it in time!

Par. No.	Name	Range	Unit	Default
P5-29	Function at Mains Phase Loss	0: No Action 1: Only Warning 2: Trip to stop and Alarm Fault (Heavy Load) 3: Trip to stop and Alarm Fault (Mid Load) 4: Trip to stop and Alarm Fault (Light Load)		3

This parameter is used to select the action in case mains phase loss.

0: No action. The product will have no protection, it's not recommended normally

1: Only warning. The product will report warning u.26 in case mains phase loss with load applied and the product will continue to run.

2: Trip to stop and alarm fault (Heavy load). The product will report alarm A.26 and trip to stop. But the product can detect the mains phase loss only when the load is full and continues for certain period time (normally in minutes)

3: Trip to stop and alarm fault (Mid load). The product will report alarm A.26 and trip to stop. But the product can detect the mains phase loss only when certain percentage of rated load is applied (normally 30%~60%)

4: Trip to stop and alarm fault (Light load). The product will report alarm A.26 and trip to stop. In this option, the protection can be triggered very fast when the product starts to ramp the motor.

Par. No.	Name	Range	Unit	Default
P5-30	Alarm/Fault Lock Handling	0: Not Lock, Alarm/Fault Resettable without Re-Power On 1: Lock, Alarm/Fault Lock Resettable only after Re-Power On		1

In default setup, the locked alarms/faults (refer to 2.6.1) cannot be reset unless power-down and power-on cycle is implemented. In some special cases, customer wants to reset the locked alarms/faults with a power-down and power-up operation, then customer can set P5-30 to 0. Please be very careful to so and consider all the safety issues.

Par. No.	Name	Range	Unit	Default
P5-31	Delay Time to Alarm Current Limit Fault	0~60	S	60

When the output current reaches the current limit level set in P5-07, a warning u.50 is triggered. When the current limit warning has been continuously present for the period specified in this parameter, the product will trip to stop and report alarm A.50. If P5-31 = 60, the alarm and trip function is disabled.

Par. No.	Name	Range	Unit	Default
P5-33	Action at Warning	0: Trip to stop and Alarm Fault directly 1: Warning and Re-catch Motor after Failure Disappear		1

This parameter is to define the action when warning like over voltage, undervoltage and over current at which the product needs to coast the motor temporary but the failure can disappear and the product needs to recover the control of the motor.

0: Trip to stop and Alarm Fault directly, at failure, the warning will turn into alarm directly and trip to stop.

1: Warning and Re-catch Motor after Failure Disappear, at failure the product will report warning and coast the motor first, when the failure disappears, the product will try to re-control the motor.

Par. No.	Name	Range	Unit	Default
P5-34	Method to Re-catch Motor at Warning	0: Speed Track (IM/PM) and Angle Track (Fly start) 1: Direct Re-catch		0

This parameter defines how the product re-control the motor when P5-33 is set to [1]

0: Speed Track (IM/PM) and Angle Track (Fly start). The product will track the speed (for both IM and PM) and angle (only for PM) of the motor first and re-control the motor with the tracked speed/angle. If it fails to track the speed/angle, the it will start the motor from 0 speed.

1: Direct Re-catch. The product will assume there is no speed change in the motor during the coasted period, and re-control the motor based on the voltage command when the warning is triggered.

Note: [1] is only for IM motor. For PM motor, it will work as [0] no matter what is set in P5-34

### 3.2.7 Parameter Group 6: Keypad Operation and Display

Par. No.	Name	Range	Unit	Default
P6-03	Customer Defined Value for 0 Speed	0.0~6553.5		0.00
P6-04	Customer Defined Value for Max Speed	0.0~6553.5		100.00

It is possible to customize a readout value in the product. Custom readout value is linear proportional to speed, it is stored in parameter P9-48.

The calculation of Custom Readout Value (P9-48) is shown below:

$$P9-48 = (P6-04 - P6-03) \times P9-07 \div P5-03 + P6-03$$

Par. No.	Name	Range	Unit	Default
P6-05	Keypad Display Option	0~8191		0

The Keypad is fixed to display the output frequency, reference and motor current (switchable by short press “ENTER” key). This parameter is used to show other physical variable (also install in parameters P9-\*), each variable corresponds to a weight. For example, if you want to display the temperature and the terminal AI1 on Keypad. You can set

$$P6-05 = 8 + 128 = 136$$

Below is the list of the weights for all physical variables.

Weight	Parameter Selected	Physical Variable
1	P9-06	Motor Voltage
2	P9-04	Motor Speed
4	P9-11	DC-Voltage
8	P9-13	Temperature
16	P9-20	Feedback Value
32	P9-45	Counter A
64	P9-46	Counter B
128	P9-24	AI1 Input
256	P9-26	AI2 Input
512	P9-35	Pulse Input1
1024	P9-43	Pulse Output1
2048	P9-48	Variable Defined by Customer
4096	P9-05	Output Power

Par. No.	Name	Range	Unit	Default
P6-31	Local/Remote Mode Selection	0: Remote Mode 1: Local Mode		0

0: Remote Mode, “RUN” key will be disabled and customers also can not stop the drive by press “STOP” key.

1: Local Mode. Customers can press “RUN” key to run the drive, press “STOP” key to stop the drive .

The reset function of “STOP” key is still valid no matter which mode be selected. Customers can press “STOP” key to reset the Alarm When the drive report unlocked Alarm.

Par. No.	Name	Range	Unit	Default
P6-34	Lock Keypad for Parameter Edit	0: Disabled 1: Enabled and Lock		0

0: Disabled

1: Enabled and Lock, prevent unauthorized editing of parameters.

Attention: This function is only valid to keypad, not active to local bus.

### 3.2.8 Parameter Group 7: Auxiliary and Special Functions

Par. No.	Name	Range	Unit	Default
P7-00	Special Operation Function	0: No Function 9: Reset Parameters to Factory Defaults		0

0: No function

9: Reset parameters to factory defaults. Reset all the parameters except for information about the drive itself and the parameters recording running history plus communication parameters P0-80~P0-82 . And the operation procedure is :

Step1:Set parameter P7-00 = 9;

Step2:Power down the product fully and power on again, the keypad shows A.01

Step3:Press the “STOP” key to clear the A.01, then the parameters are reset.

Par. No.	Name	Range	Unit	Default
P7-01	Function at Re-Power (for Local Mode Only)	0: Resume with Set Value as Set before Re-power 1: Not Run, but Keep Set Value as Set before Re-power 2: Not Run and Clear Set Value		1

Selects the action upon reconnection of the drive to mains voltage after power down in Hand operation mode.

0: Resume with Set Value as Set before Re-power. Restart with the same local set value and the same start/stop settings as before the drive was powered down.

1: Not Run, but Keep Set Value as Set before Re-power. Keep to the stop status until a new start command is given. The set value set before the drive was powered down is saved and will be used if a new start command is given.

2: Not Run and Clear Set Value. Keep to stop status and clear the set value unit new commands are given.

Par. No.	Name	Range	Unit	Default
*P7-10	Min Switch Frequency	2~16: 2~16 kHz	kHz	2

Limit the permissible minimal switching frequency also for temperature auto tuning functions

Par. No.	Name	Range	Unit	Default
*P7-11	Over Modulation Coefficient	90.0~105.5	%	100.0

Increase this parameter can increase the ability to output higher voltage with same mains voltage. But increase the ability could result in more harmonic voltage/current on the motor.

Par. No.	Name	Range	Unit	Default
*P7-12	DC-Link Voltage PWM Compensation Function	0: Compensate Average DC voltage 2: Compensate DC Ripple Voltage		0

When DC voltage changes, the PWM signals need compensation to apply the right voltage to the motor. This parameter defines how the product compensate the voltage changes.

0: Compensate Average DC voltage. The product only compensates the changes of the average DC voltage discarding the rectifying ripple voltage.

2: Compensate DC Ripple Voltage. The product compensates the ripple voltage as well as the average voltage change. This function can reduce the harmonic torque but the effect will be limited if the mains voltage is too low.

Par. No.	Name	Range	Unit	Default
P7-13	DC-link Voltage PWM Compensation Disable at VF control	0: Disable; 1: Enable		1

This function is used to disable the compensation function at VF control mode. Normally this is used to improve the ramp down capability by dissipating the braking energy in the motor. But doing so is risky to damage the motor in case the mains voltage is high.

Par. No.	Name	Range	Unit	Default
P7-14	Dead Time Compensation Adjustment Coefficient	0~200	%	100

This parameter is used to adjust the dead time compensation due to the tolerance between ideal dead time and real deadtime. 100% means compensate based on ideal dead time, lower than 100% means compensate less than the ideal dead time, higher than 100% means compensate more than the ideal dead time.

Par. No.	Name	Range	Unit	Default
P7-17	Max Frequency for Dead Time Compensation	20~400	Hz	*

From frequency P7-17 and higher, the deadtime compensation coefficient will drop to 0 and the deadtime compensation function is disabled. From 0Hz to P7-17, the deadtime compensation coefficient drops from P7-14 to 0 linearly.

Par. No.	Name	Range	Unit	Default
P7-36	Method to Reset Alarm Fault	0: Reset by Command 1~10: Auto Reset for 1~10 Times 11: Auto Reset for Unlimited Times		0

Define how the alarm faults can be reset.

0: Reset by Command. The alarm faults can on be reset by a command, pressing the “STOP” key, the DI inputs or communication reset command

1~10: Auto reset for 1-10 times. The product can reset 1~10 times of alarm faults automatically after the alarms are triggered.

11: Auto Reset for Unlimited Times. The product will reset the alarm faults without limitation.

Note:

1. The product can only reset the alarm fault when the failure reason is cleared. Even if the product fails to reset the alarm fault, it will be counted in times.
2. This function works for locked alarm faults only if P5-30=0
3. The count of times will be cleared to 0 when the product is re-powered
4. This function does not work for warnings.

Par. No.	Name	Range	Unit	Default
P7-37	Alarm Auto Reset Waiting Time	0~600	s	10

Set the time interval from alarm faults to perform the automatic reset function. This parameter is active only when P7-12 set to [1] ~ [10].

Par. No.	Name	Range	Unit	Default
*P7-38	VT Function Level	40~90	%	90

Enter the level of motor magnetization at low speed. Selection of a low value reduces energy loss in the motor, but also reduces load capability, especially for start.

Par. No.	Name	Range	Unit	Default
P7-46	Threshold Voltage for OVC Function	Grid Voltage Dependent	V	*

When the DC link voltage exceeds the value of P7-46, over-voltage control defined in P7-47 is activated.

The following table is the Over-voltage Control Threshold Voltage's range and default value depending on P1-01 Grid Type:

Grid Type	Range	Default
200~240V	360~395V	385V
380~440V	680~780V	710V
440~480V	750~780V	780V

Par. No.	Name	Range	Unit	Default
P7-47	OVC Function	0: Disable 1: Enable		0

Over-voltage control (OVC) can limit the voltage in DC link when ramp down the motor by limiting the ramp down speed. It is not suitable for application with continuous potential energy feedback, e.g. lift.

Note: If the resistance braking threshold voltage is lower than the overvoltage control threshold voltage, the resistance braking will take effect first. If the overvoltage control threshold voltage is set lower than the resistance braking threshold voltage, the overvoltage control will take effect first.

Par. No.	Name	Range	Unit	Default
P7-48	OVC Integral Time	0.01~0.10	s	*
P7-49	OVC Proportional Gain	0~200	%	*

Define the controller used in OVC control.

Note: These parameters are only active when selecting [2] Mode 1 or [3] Mode 2 in P7-47.

Par. No.	Name	Range	Unit	Default
P7-50	Bypass Speed Start 1	0.0 ~ 400.0	Hz	0.0
P7-51	Bypass Speed End 1	0.0 ~ 400.0	Hz	0.0
P7-52	Bypass Speed Start 2	0.0 ~ 400.0	Hz	0.0
P7-53	Bypass Speed End 2	0.0 ~ 400.0	Hz	0.0
P7-54	Bypass Speed Start 3	0.0 ~ 400.0	Hz	0.0
P7-55	Bypass Speed End 3	0.0 ~ 400.0	Hz	0.0

These parameters are used to define 3 ranges of speed in which the motor should not stay to avoid the mechanical resonance. If the speed is set within the range, the set speed will be move to the closest start point or end point of the bypass speed range.

### 3.2.9 Parameter Group 8: Basic and Running Information

Par. No.	Name	Range	Unit	Default
P8-00	PU SW Version			

View the software version of the Power Unit.

Par. No.	Name	Range	Unit	Default
P8-30	Total Days with Power On	0~9999	d	

View how many days the drive has been power on. This value can't be reset.

Par. No.	Name	Range	Unit	Default
P8-31	Total Running Hours	0~60000	h	

View how many hours the motor has run. Reset the value to 0 by P8-37 Reset Running Hours Counter.

Par. No.	Name	Range	Unit	Default
P8-32	Total Energy Consumed	0~65535	kWh	

View the total power consumed. Reset the the value to 0 by P8-36 Reset Consumed Energy Counter.

Par. No.	Name	Range	Unit	Default
P8-33	Number of Power Ups	0~65535		

View the number of times the drive has been powered up. This parameter can't be reset.

Par. No.	Name	Range	Unit	Default
P8-34	Number of Over-Temperatures	0~65535		

View the number of that how many over-temperature faults have occurred. This parameter can't be reset.

Par. No.	Name	Range	Unit	Default
P8-35	Number of Over-Voltages	0~65535		

View the number of that how many over-voltage faults have occurred. This parameter can't be reset.

Par. No.	Name	Range	Unit	Default
P8-36	Reset Consumed Energy Counter	0: Not Reset; 1: Reset		0

0: Not reset;

1: Reset. Reset the counter to zero (see P8-32);

Attention: This parameter can't be set via bus communication.

Par. No.	Name	Range	Unit	Default
P8-37	Reset Running Hours Counter	0: Not Reset; 1: Reset		0

0: Not reset;

1: Reset, running hours counter is reset to zero (see P8-31);

Attention: This parameter can't be set via bus communication.

Par. No.	Name	Range	Unit	Default
P8-40~P8-49	Alarm Log			

These are the 10 latest occurred Alarm Log.

Par. No.	Name	Range	Unit	Default
P8-50~P8-59	Warning Log			

This is the 10 latest occurred Warning Log.

### 3.2.10 Parameter Group 9: Real Time Running Status Monitoring

Par. No.	Name	Range	Unit	Default
P9-00	Control Word	0~65535		
P9-01	Status Word	0~65535		
P9-02	Set Value	-4999.0~4999.0		
P9-04	Motor Speed	0~24000	rpm	
P9-05	Output Power	0.000~655.35	kW	
P9-06	Output Voltage	0.0~6553.5	V	
P9-07	Output Frequency	0.0~590.0	Hz	
P9-08	Output Current	0.00~655.35	A	
P9-09	Output Torque	-200.0~200.0	%	
P9-10	Motor Thermal Load Status	0~100	%	
P9-11	DC Link Voltage	0~65535	V	
P9-13	Heatsink or IGBT Temperature	-128~127	°C	
P9-14	Inverter Thermal Load Status	0~255	%	
P9-15	Nominal Inverter Current	0.0~6553.5	A	
P9-16	Max Inverter Current	0.0~6553.5	A	

Par. No.	Name	Range	Unit	Default
P9-17	Power Board Temperature	-128~127	°C	
P9-18	Rectifier Temperature	-128~127	°C	
P9-19	PID Set Value	-200.0~200.0	%	
P9-20	PID Feedback Value	-200.0~200.0		
P9-21	PID Output	-200.0~200.0	%	

These parameters are used to view the running status of the product.

Par. No.	Name	Range	Unit	Default
P9-22	Digital Input	0~65535		

View the status of the digital input. Each digital input terminal corresponds to a weight, as shown in the following table. If the drive detects that the digital input terminal is valid, it has a weight, otherwise it does not, and the weight value is added to the parameter value.

For example: REV and DI2 are valid, P9-22 = 2 + 8 = 10.

Terminal Weight	DI4	DI3	DI2	DI1	REV	FWD
	32	16	8	4	2	1

Par. No.	Name	Range	Unit	Default
P9-23	AI1 Analogue Input Type	0: 0~10V 1: 0~20mA		
P9-24	AI1 Input Value	0.00-20.00	V/mA	
P9-25	AI2 Analogue Input Type	0: 0~10V 1: 0~20mA		
P9-26	AI2 Input Value	0.00-20.00	V/mA	

Par. No.	Name	Range	Unit	Default
P9-39	Relay Output Status	0~1		

View the status of the relay output. Each relay output terminal corresponds to a weight, as shown in the following table. If a relay output terminal is valid, it has a weight, otherwise it does not, and the weight value is added to the parameter value. For example: Relay1 is valid, P9-39 = 1.

Par. No.	Name	Range	Unit	Default
P9-40	AO1 output	0.00-20.00	V/mA	

Par. No.	Name	Range	Unit	Default
P9-45	Counter A Value	0~65535		
P9-46	Counter B Value	0~65535		
P9-47	Set Value from Bus Communication	-32768~32767		
P9-48	Variable Defined by Customer	0~6553.5		

### 3.2.11 Parameter Group 19: Simple PLC

Par. No.	Name	Range	Unit	Default
P19-00	SPLC control mode	0 : once running then keep running 1 : once running then stop 2 : cycle running		0

0: once running then keep running. it will keep running the last step speed after inverter finished all steps.

1: once running then stop.it will stop after inverter finished all steps.

2: cycle running, it will cycle again after inverter finished all steps.

Par. No.	Name	Range	Unit	Default
P19-01	SPLC store selection	0 : No function 1 : save at Stop 2 : save at Power down		0

0: No function. do not save current running step and speed when inverter stop or power down.

1: save at Stop. it will save current running step and speed when inverter stop.

2: save at Power down. it will save current running step and speed when inverter power down or stop.

Attention: If inverter saved running step and speed, inverter will start running from saved step and speed when inverter run again. If inverter do not save running step and speed, inverter will start running from step0 and speed 0HZ when inverter run again.

Par. No.	Name	Range	Unit	Default
P19-10~P19-25	SPLC multi-speed0~ SPLC multi-speed15	-100.00%~100.00%	%	0

P19-10~P19-25: 16 steps speed , 0.00% is corresponding to 0HZ, 100% is corresponding to P0-16

Par. No.	Name	Range	Unit	Default
P19-26~P19-41	SPLC step 0 ramp time ~ SPLC step 15 ramp time	0.0~6000.0	S	0

P19-26~P19-41: 16 steps ramp time(the time from former step speed ramp to current step speed).Example: if P19-27(step 1 ramp time)=5S, it means it need 5 seconds from step 0 speed(P19-10) ramp to step 1 speed(P19-11).

Par. No.	Name	Range	Unit	Default
P19-42~P19-57	SPLC step 0 running time~ SPLC step 15 running time	0.0~6000.0	S	0

P19-42~P19-57:16 steps running time. please refer the picture below about the ramp time and running time detail description .

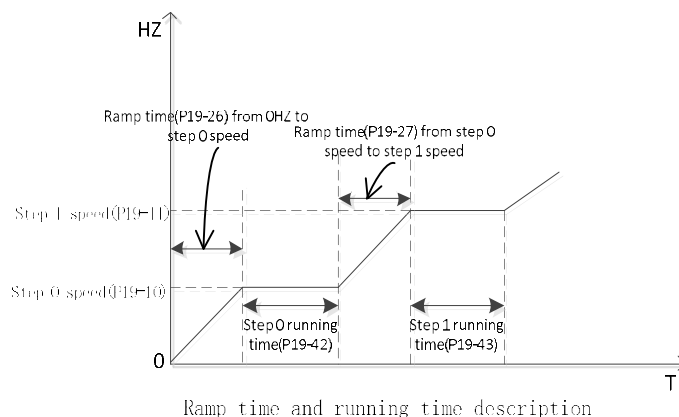

Attention: If step X ramp time and running time are 0S, then all steps after X will be disabled. Example: set P19-29(step3 ramp time)=0 and P19-45(step3 running time)=0, then from step3 to step15 will be disabled.

Par. No.	Name	Range	Unit	Default
P19-80	Average Speed	0~65535	RPM	

This parameter is Read only, it is used to monitor the one cycle average speed.

Par. No.	Name	Range	Unit	Default
P19-81	Current Running step	0~15		

This parameter is Read only, it is used to monitor the Current Running step.

Par. No.	Name	Range	Unit	Default
P19-82	Current Running step time	0.0~6553.5	S	

This parameter is Read only, it is used to monitor the Current Running step time.

Par. No.	Name	Range	Unit	Default
P19-83	Reset times	0.0~65535	S	

This parameter is used to monitor the SPLC reset times

Attention: SPLC function use steps:

- a. Set P0-03=2 (enable SPLC function)
- b. Set one DI terminal function (P2-05~P2-10)to 64
- c. Set parameters Group 19 based on application request.
- d. Ensure Drive is in remote mode, set DI terminal( which function set to 64) to active, then SPLC start running.

### 3.2.12 Parameter Group 20: Pump application

Par. No.	Name	Range	Unit	Default
P20-00	pump control mode	0 : pressure mode		0



0: Pressure close loop mode, it will automatically change relative parameters.P0-11=21(The main speed source is Process PID), P4-00=1(the pressure feedback source is AI1,default is 0~10V voltage input),P4-01=11(set object pressure by P0-30)

Par. No.	Name	Range	Unit	Default
P20-01	minimum output frequency	0.00~P20-02	%	40
P20-02	maximum output frequency	P20-01~100.00	%	100

Running speed range: 0.00% is corresponding to 0HZ,100% is corresponding to P0-16.

Par. No.	Name	Range	Unit	Default
P20-60	Sleep enable selection	0 : disable 1 : enable		0

0: sleep function disable

1: enable sleep function

Par. No.	Name	Range	Unit	Default
P20-61	Sleep frequency threshold	0.00~100.00	%	2

If output frequency < P20-01+P20-61, sleep frequency condition satisfied.

Par. No.	Name	Range	Unit	Default
P20-62	Sleep pressure threshold	0.00~100.00	%	2

If feedback pressure > object pressure - P20-62, sleep pressure condition satisfied.

Par. No.	Name	Range	Unit	Default
P20-63	Sleep detection time	0.0~300.0	S	10

If inverter satisfy sleep frequency and pressure condition more than detection time P20-63, then inverter will enter sleep state.

Par. No.	Name	Range	Unit	Default
P20-64	minimum sleep time	0.0~1800.0	S	300

When inverter enter sleep state, it will sleep at least time P20-64,then inverter will try to check wake up condition.

Par. No.	Name	Range	Unit	Default
P20-65	wake up pressure threshold	0.00~100.00	%	10
P20-66	wake up detection time	0.0~60.0	S	1

If feedback pressure < object pressure - P20-65 more than detection time P20-66,then inverter will wake up and run again.

About the detail speed and wake up logic, please refer the picture below:

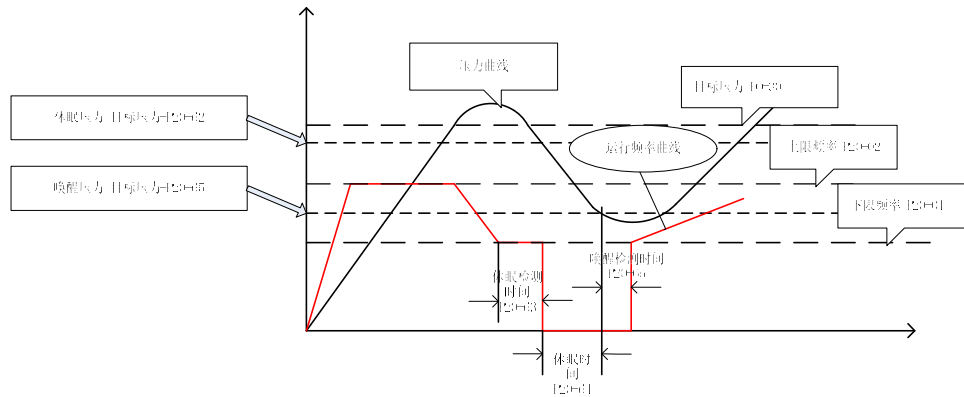

Sleep and wake up description

Attention: pump application use steps:

- Set P0-03=1 (enable Pump function).
- Set one DI terminal function (P2-05~P2-10)to 64
- Set parameters Group 20 based on application request. If customer want use sleep function, please set P20-60=1.
- Ensure Drive is in remote mode, set DI terminal( which function set to 64) to active, then Pump function start running
- Pressure unit description: all the pressure relative parameter (P0-30,P20-62,P20-65) units are percent(%),100%=the pressure sensor maximum feedback. Example : if the pressure sensor signal is 4~20MA,and the measure range is 0~1Mpa, first you need set AI2 as pressure feedback source(P4-00=2) and change AI2 input range(P3-14=4 and P3-15=20),then if you set P0-30=40%,it means the object pressure is 0.4Mpa.
- About the sleep and wake up condition details, please refer picture above: only two sleep conditions(output frequency and feedback pressure) are satisfied, then sleep state can be active.

## Chapter 4 The introduction of Keypad KP00

The keypad built in can be used for parameter set/read, control and monitoring etc. Below shows the appearance of the keypad.

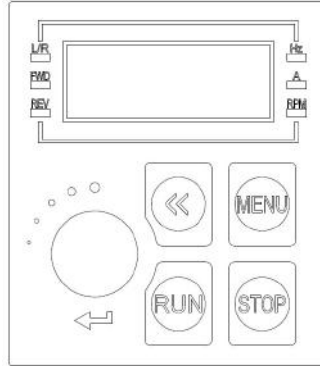

The product can be set by P6-31 to two different running modes: Local Mode and Remote Mode.

**Local Mode:** The product is controlled by keypad, including start/stop and target frequency set etc.

**Remote Mode:** The product is controlled by I/O terminals or communication Bus, keypad is only for monitoring and parameter setup.

Description of the lights on keypad

L/R Light: To indicate the mode of the product, Always On --- Remote Mode, Flashing --- Local Mode.

FWD、REV Lights:

FWD	REV	Status
On	Off	Running in Forward Direction
Off	On	Running in Reverse Direction
Off	Off	Stopped

LED lights of “Hz”, “A”: Used to indicate the physical meaning of the values shown on the key pad, please refer to the section 3.2.2

The five digits LED display can show the reference frequency, parameter number or value, alarm/warning code etc.

### 4.1 Introduction of the keys:

Key Name	Function
<<	In home display, press to switch the physical variables shown for monitoring; In parameter number selection, press to switch the digit place of the parameter number to be modified; In parameter value modification, press to switch the digit place of parameter value to be modified
STOP	Press to control the product stop when product is in Local Mode or reset the fault (if there is alarm)
MENU	Press to enter the menu for parameter setup or exit the menu
ENTER/Potential meter	1. Press to confirm the parameter number selection and enter the parameter value displaying/modification, or press to confirm the parameter value and back to the Parameter number selection menu. 2. Turn the potential meter to change the reference in home display of local mode, or to adjust the parameter number or to adjust the parameter value in parameter setup
RUN	Press to run the motor when product is in Local Mode.

### 4.2 Setting of the parameters

Take changing the parameter P1-06 “rated motor current” to 9.6A as an example:

1. From home display, press the “MENU” key to enter the parameter number selection display;
2. Press the “<<<” key to select the digit place of parameter number you want to change and turn the potential meter to adjust the parameter number to “P1-06”
3. Press the potential meter to confirm the parameter number selection and enter the parameter value modification display.

4. Press the “<<” key to select the digit place of parameter value you want to change and turn the potential meter to adjust the parameter value to “9.6”
5. Press the potential meter to confirm the parameter value input and back to the parameter number selection display, parameter number “P1-07” will be shown.
6. Repeat the operation steps 2 to 5 if more parameters need to be changed. press the “MENU” key back to the home display

Note: In parameter number selection or parameter value modification, if no operation for certain period, the keypad will jump back to the home display automatically

### 4.3 Monitor the Product Status

In the default setup, the keypad will only show one of the motor frequencies, set value and motor current in home display (switchable by “<<” key). If more physical variables need to be shown in the home display, you can set the parameter P6-05. You can use the “<<” key to switch and select one of the variables defined in P6-05 and show it in the home display.

Blow table shows the meaning and how them will be shown for the main physical variables which can be defined in P6-05.

Physical Variable	Monitoring Parameter	Indication Character	LED lights Status
Output Frequency	P9-07	T	“Hz” Always On
Set Value	P9-02	N/A	“Hz” Always On "A" Always ON
Motor Current	P9-08	A	"A" Always On
Motor Voltage	P9-06	N/A	“Hz” Always On “RPM” Always On
Motor Speed	P9-04	N/A	“RPM” Always On
DC Voltage	P9-11	N/A	"A" Always On “RPM” Always On
Inverter Temperature	P9-13	N/A	“RPM” Flashing
Feedback Value	P9-20	N/A	“Hz” Always On “RPM” Flashing
Analogue Inputs	P9-24 or P9-26	N/A	“Hz” Flashing “RPM” Flashing

### 4.4 Check the Fault Log (Warning or Alarm Log)

The keypad will show the fault code when any fault is triggered. The product can log 10 latest warnings and 10 latest alarms. You can check the latest warning information via parameters P8-40~P8-49 and alarms via parameters P8-50~P8-59.

#### 4.5 Comparison Table for Character Displaying

0	1	2	3	4	5	6	7	8	9
0	1	2	3	4	5	6	7	8	9
A	B	C	D	E	F	G	H	I	J
A	B	C	D	E	F	G	H	I	J
K	L	M	N	O	P	Q	R	S	T
	L		n	o	p	q	r	s	t
U	V	W	X	Y	Z	-	+	.	=
U	U			y	z	-	+	.	=
a	b	c	d	e	f	g	h	i	j
A	B	C	D	E	F	G	H	I	J
k	l	m	n	o	p	q	r	s	t
	L		n	o	p	q	r	s	t
u	v	w	x	y	z				
u	u			y	z				

# Chapter 5 Fault Handling and Maintenance

## 5.1 Fault Handling

### 5.1.1 Fault codes and Handling

AD80 classify the Faults into 3 categories: Warning, Alarm and Error and they can be shown on the keypad with defined codes.

Warning is for faults close to design limit or parameter set limit, but with which the product can continue to work under a designed control or the product can suspend and recover automatically when the anomaly disappears. Customer can monitor the specific warning information via keypad or communication bus. On an LED keypad, the warning will be shown as ‘u.XX’. ‘u’ means warning, ‘XX’ represents the code of the fault.

Alarm is for faults which could damage the product or other equipment in short time so that the product must be disabled from the system immediately. When an alarm is triggered, a ‘reset’ operation must be taken by a command from keypad or from the upper controller before the product can run again. On an LED keypad, the alarm will be shown as ‘A.XX’. ‘A’ means alarm, ‘XX’ represents the code of the fault. To eliminate some of the faults, customers must power down the product and do debug or test on part of the circuits. For this type of faults, AD80 affords lock function and when the fault is triggered it will be locked. The locked fault cannot be reset until a power down-power on cycle is operated and the reason for fault is cleared. This type of faults is called locked-fault. All locked-fault will be treated as ‘alarm’ as well. Customer can disable the lock function for some of the locked-fault by setting P5-30=0. Doing this, the customer must be very careful and be responsible for the safety.

Error is for mis-operation from the customer, e.g. trying to change a parameter value via Keypad which is not allowed to change. An Error will be shown as ‘Er. XX’ on an LED keypad. The product will continue to run and the Error will not be logged.

Below is the list for all the faults:

Warning	Alarm	Error	Fault Name	Reason Description	Suggested Handling
	A.01		Factory Reset	Parameters reset to factory defaults without confirmation	Press "STOP "key to Confirm
	A.02*		Internal Fault		Contact our local support or SSInverter Company
u.03	A.03*		Motor control/IO communication time out	Motor control board Failed to communicate with IO board	1.Power off, then confirm the installation of IO board 2.Contact our local support or SSInverter Company
	A.04*		Power Board 24V Error	Internal Hardware fault	1. Confirm no problem in external load to 24v 2. Contact our local support or SSInverter Company
	A05*		Gate drive voltage fault	Internal Hardware fault	
u.07	A.07*		Fan Fault	Too much dust on the fan or the fan is aged	Clean or replace the fan
	A.16*		Short Circuit	Short circuit between phases of motor	Check the motor cable and motor insulation status
u.17	A.17*		Earth fault	Flashover or short circuit between output phases and ground	1.Check cable or motor phase to ground insulation status 2.Replace cable or motor
u.19	A.19*		Brake resistor short-circuit	Brake resistor is short circuit (22kW and below)	Check the wire of brake resistor or Replace Brake resistor
u.20	A.20*		Brake transistor short-circuit	Brake transistor is damaged (22kW and below)	Contact our local support or SSInverter Company to repair
u.21	A.21*		Brake Detect	Brake resistor is not connected or working.	Check the Brake resistor or replace suitable Brake resistor
u.23	A.23		Over Current at low voltage	Over current due to that power supply voltage dips too much	Check the Power supply
u.24	A.24		Under Voltage	Power supply voltage dips too much, or high load to too low power supply voltage	Check the Power supply
u.25	A.25		Overload at low voltage	High load at continuous low power supply voltage	Check the Power supply
u.26	A.26*		Mains Phase Loss	Missing phase on supply side	1.Check the Power supply

Warning	Alarm	Error	Fault Name	Reason Description	Suggested Handling
u.27	A.27		KEB fault	KEB function triggered but failed to hold the DC voltage at power supply voltage drop, due to too less inertia or too long time for power supply voltage drop.	1.Check the Power supply 2.Set suitable KEB Threshold voltage
	A.28*		Motor phase U missing	1.motor phase imbalance 2.motor cable loose	Check the motor phase cable and motor.
	A.29*		Motor phase V missing		
	A.30*		Motor phase W missing		
u.36	A.36		Over Voltage	1. The input voltage is too high; 2. The motor works in generator mode; 3. The deceleration time is too short; 4. The braking unit and braking resistor are not installed.	1. Check the power supply 2. Use brake resistor or energy feedback unit to consume or use up the generate energy 3. Adjust relative parameters to avoid the motor working in generator mode
u.37	A.37		IGBT Over Temperature	Too high load or the cooling condition beyond the specification	1. Check the load 2. Check the cooling condition, include to clean the airduct or replace the fan
u.43	A.43		Power Board Over Temperature	Too high load or too high ambient temperature	1. Check the load 2. Check the cooling condition, include to clean the airduct or replace the fan
u.45	A.45		Over Current	1. Motor parameters and/or motor control parameters are not set appropriately; 2. The power size of inverter is too small comparing to the motor or the load 3. The power supply voltage is too low; 4. The inverter failed to catch a spinning motor at fly	1.Adjust relevant parameters 2.Select inverter with higher power rating 3.Check the power supply voltage 4.Contact our local support or SSI Company
u.46	A.46		Drive Overload	1. Too heavy load or too low power supply voltage 2. The power size of inverter is too small comparing to the motor or the load 3. Motor parameters and/or motor control parameters are not set appropriately;	1.Correctly set relevant parameters especially the motor parameters 2.Select inverter with high power rating. 3. Contact the local distributor or SSI Company
u.48	A.48		Motor Over Temperature	1. Too heavy load on the motor 2. Cooling condition for the motor is not good enough 3. Thermistor for motor temperature sensing is not used correctly	1.Check selection/installation of the thermistor for motor temperature sensing 2.Check the cooling conditions for motor 3. Check the load versus rated power of the motor
u.49	A.49		Motor Overload	1. Motor parameters and/or motor control parameters are not set appropriately; 2. Too heavy load on the motor	1. Correctly set relevant parameters especially the motor parameters 3. Check the load versus rated power of the motor
u.50	A.50		Current Limit	Current exceeds the parameter set max. current (P5-07) due to: 1. Too heavy load comparing to the power size of the inverter 2. Too fast ramp with inertia 3. Too low power supply voltage 4. Motor parameters and/or motor control parameters are not set appropriately;	Adjust P5-07 or try A.45 solution

Warning	Alarm	Error	Fault Name	Reason Description	Suggested Handling
u.51	A.51		Torque Limit	Torque exceeds the parameter set max. torque (P5-04/P5-05).	Adjust P5-04/P5-05 or try A.45 solution
u.57	A.57		Analogue input terminals Error	1. Wire connection problem 2. The parameters for AI1/AI2 live zero are not correctly set	1. Check the wire connection 2. Adjust the relevant parameter setup
u.62	A.62		Communication Timeout	Drive communication timeout (with external controller PC/PLC/HMI etc.) 1. External controller abnormal 2. communication line connection problem 3. communication Parameters(P0-8X) incorrect. 4.EMC problem.	1.Check external controller PC, PLC, HMI etc. 2.Check communication line connection 3.Correctly set communication parameters(P0-8X) 4. Wiring the communication cables correctly, including shielding and grounding 5.Contact our local support or SSInverter Company
u.66			Motor Loss	Motor cable connection or motor problems;	Check motor cable or motor phase
	A.69		Mechanic Brake Current Low	Actual motor current cannot exceed release brake current (P1-97~P1-98) within start delay time.	Correctly set mechanical brake parameters(P1-97~P1-98)
u.75			Drive License Timeout	Drive License Timeout function activated	Contact our local support or SSInverter Company
u.76	A.76		External alarm	DI terminals select external alarm function	Check external alarm source
		Er.90	Keypad communication Timeout	Keypad Failed to communicate with inverter	1.Power off, then confirm the installation of the keypad 2.Contact our local support or SSInverter Company
		Er.93	Parameter change disabled	The parameter cannot be changed when Drive running	Change the parameter after Drive stop
	A.99		AMA Error	Failed to finish the motor parameter auto tuning	Correctly set motor parameters according to motor nameplate

Note: The Alarms marked with '\*\*' are locked-faults.

### 5.1.2 How to Get the Fault Info

The customer can get the fault information from the keypad display or get the fault information via the RS485

## 5.2 Maintenance

The parts of product could be impacted by the environment temperature, humidity, vibration, salt mist, dust etc. Proper maintenance of the product during storage and running is important to keep the product from failure and life reduction.

### 5.2.1 Routine Inspection

Below items should be suggested for routine inspection:

Any abnormal sound from the motor during running?

Any abnormal vibration from the motor during running?

Is there any special change in the installation environment?

Are the cooling fans running ok?

Check the temperatures inside the product via the parameter group 9

Check the motor voltage, current and frequency

Is there any special dust, e.g. metal dust or corrosive liquid?

### 5.2.2 Maintenance

According to the application, customer can check the product at a regular interval, e.g. every 3~6 months to clear the hidden problem.

Items for Maintenance	Measures
Control terminals loose?	Fasten the screws with a torque-controlled screw driver if loose
Power terminals loose	Fasten the screws with a torque-controlled screw driver or socket wrench if loose
PE terminals loose?	Fasten the screws with a torque-controlled screw driver or socket wrench if loose
Fixation of the product loose?	Fasten the screws with a torque-controlled screw driver or socket wrench if loose
Control wire or power cable worn?	Replace the wire or cable
Air duct blocked?	Clean the air duct
Fan speed too low or blocked?	Clean or replace the fan

Caution:

Please power off the product and wait for enough time to ensure safety before maintenance;

Avoid dropping any screws, wire lead and other metal materials inside the product, otherwise it could be damaged when power on;

It is forbidden to do any change inside the product.

### 5.2.3 The storage and transportation of product

The product should be stored inside the package before installation. Below items are demanded for storage:

In a dust free and dry environment;

Storage temperature: -25°C~65°C;

Storage humidity: 5%-95% and no condensing;

Storage in environment without corrosive gas or liquid;

Put on shelf away from the ground with package;

Transportation ambient temperature: -25°C~70°C;

Transportation ambient humidity: below 95%

Caution: It's inadvisable to store the product for longtime due to electrolytic capacitors inside. If you DO need to store the product for long time please follow bellow rules:

Power the product every 6 months for more than 5 hours in a special way

Power the product before the first time running in a special way

The special way to power the product means to power the product with a voltage and current controlled supply and increase the voltage slowly, normally with a voltage regulator.

Power the product directly to high voltage after long time storage could explode the electrolytic capacitors.

### 5.2.4 Scrapping of the product

Materials used in the product are recyclable to save resource and protect the environment. For example, the package material is biodegradable and recyclable. All the metal parts can be recycled as well as the plastic and rubber. Scrapping the Printed Circuit Board and electrolytic capacitor should follow standards IEC62635. All the handling for scrapping of the product should follow the local regulations.



## Chapter 6 SSI80 Basic Application Guide

This chapter describes the basic operations via keypad or control terminals. Operation via communication buses is similar by sending control commands to the SSI80 and/or setting the parameters (Please refer to Appendix) of SSI80.

### 6.1 Control with Keypad

1. Ensure the product is working in Local Mode (L/R light flashing), or set P6-31=1 to switch to Local Mode.
2. Adjust the set frequency by turning the potential meter.
3. Press the “RUN” key to start the motor, and adjust the motor speed by turning the potential meter.
4. Press the “STOP” key to stop the motor.

Note: In Local Mode, the product only receives commands from the keypad. Normally Local Mode is for system debugging.

### 6.2 Control with Terminals

1. Ensure the product is working in Remote Mode (L/R light always ON). If not, switch the product to the Remote Mode by set P6-31=0. The product is default in Remote Mode.
2. Control in default parameter setup: In default, the DI terminal named as “FWD” is set to function of start/stop (P2-05=10), the DI terminal named as “REV” is set to function of reverse run (P2-06=12), and the main set value source is set to AII terminal (P0-11 = 1), and the AII terminal is set as analogue voltage input (P3-00=0). In the default parameter setup, you can start the motor forward direction by enabling the signal to terminal “FWD” (short circuit the “FWD” terminal to “GND”) and stop the motor by disconnecting the terminal “FWD” from terminal “GND”. You can start the motor reverse direction by connecting the terminal “REV” to “GND” and stop the motor by disconnecting the terminal “REV” from terminal “GND”. You can change the motor speed by adjusting the voltage on terminal AII.
3. Control with Preset multi-stage value: Based on the default parameter setup, you need to change the main set value source to preset multi-stage value (P0-11=11) and keep the function of terminals “DI1”~“DI3” as default (P2-07~P2-10 = 22~24), and set the preset values in parameters P0-30~P0-37 to the speeds you expect. Then you can change the motor speed to preset value by changing the logic status of terminals “DI1” ~ “DI3”.

### 6.3 Reset the parameters to Factory Defaults

1. Set parameter P7-00 = 9;
2. Power down the product fully and power on again, the keypad shows A.01
3. Press the “STOP” key to clear the A.01, then the parameters are reset to factory defaults except for the parameter group 8 and group 9.

### 6.4 Reset the Faults (Alarms)

For non-locked faults, press “STOP” key to reset the fault.

For locked faults:

If parameter P5-30 = 0, press “STOP” to reset the fault;

If parameter P5-30 = 1, you need to power down and power on first, then press “STOP” key to reset the fault.

You can also set a DI terminal function to reset fault (set one of the parameters from P2-05 to P2-09 equals 1), and use DI signal to reset the fault.

## 6.5 Motor Parameters Auto Tuning

Correct motor parameters help to ensure the control performance. Motor parameter auto tuning function can identify the motor parameters (parameters from P1-14 to P1-27) automatically. If you did not run the motor parameter auto tuning operation, the control will use default motor parameters or use the parameters you set manually.

1. Ensure the motor is standstill
2. Set Parameters from P1-02 to P1-07 as the nameplate of the motor
3. Set parameter P1-13 to value 1 or 2 or 3 or 4 or 5 depending on your demands (Refer to description of parameter P1-13 in 3.3.2). After you confirm the parameter P1-13 value, the keypad will show “PUSH” “RUN”. Then press the “RUN” key, the product starts the motor parameter auto tuning function
4. Wait the until the keypad shows “PUSH” “Ent”, then press the “ENTER” key. The motor parameter auto tuning function finished and the motor parameters are updated.

Note: You can stop the motor parameter auto tuning function by press the “STOP” key.

# Appendix A. Modbus Communication Guidance

The AD80 drive provide RS485 communication interface. It adopts international standard Modbus communication protocol to perform master-slave communication. The user can realize centralized control through PC/PLC to adapt specific application requirements.

## 1. Application Mode

### 1.1 Interface Mode

The communication interface is RS485. RS485 works on semi duplex and its data signal applies differential transmission which is called balance transmission too.

### 1.2 Networking Mode

The drive has two networking modes: single master/multiple slaves networking and single master/single slave networking.

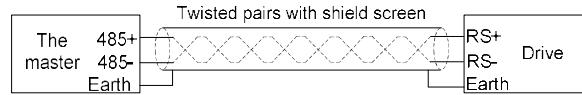

Single master/single slave networking diagram

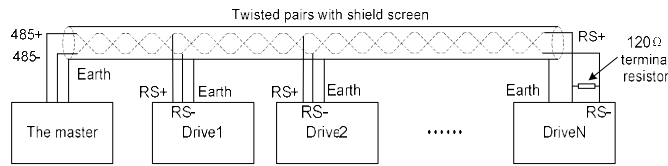

Single master/multiple slaves networking diagram

Specification:

1. No matter which mode, the drive is used as a slave in communication. When master sends commands using broadcast address, the slave does not respond;
2. It is recommended to use shield cables in multiple connection. The basic parameter of the devices, such as baud rate and digital check bit in RS485 should be the same as slave device's and there should be no repeated addresses in slave devices.

## 2. Protocol Format

Modbus protocol only support RTU mode.

RTU data frame format is shown as the figure below:

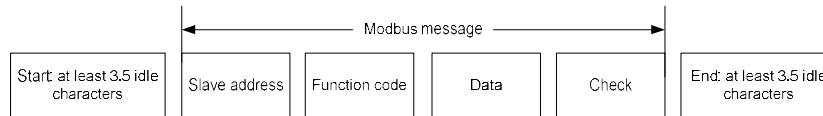

Specification:

Start		At least 3.5 idle characters	
Slave address	Address: 0-127(0 is broadcast address)		
Function code	Modbus function code		
Data (N-1)	2 * N data		
Data (N-2)			
...			
Data 0			
CRC CHK high-8-bit	CRC check		
CRC CHK low-8-bit			
End	at least 3.5 idle characters		

## 3. Function Code

Function code supported by AD80 drive Modbus protocol are as shown in the table below:

Function code	Description	Meaning
0x03	Read Holding Registers	Read drive functional parameters and running status parameters
0x06	Preset Single Register	Over-write individual drive functional parameters
0x10	Preset Multiple Regs	Over-write multiple Registers

## 4. Register Address Definition

All the following register addresses are started from 0.

### 4.1 The Rules of Register Address of the Parameter Number

The parameters can be mapping to register address. The rules of register address of the parameter number are shown below:

Register address = PNU – 1

For example: The register address of P0-30 is 30 - 1 = 29 (0x001D)

The register address of P9-11 is 911 - 1 = 910(0x038E)

Attention: Parameters Group 8 and 9 are Read-only.

The Drive don't support write or read multiple parameters at a time.

## 4.2 Other Register Addresses Specification

In addition to parameter is mapped to Modbus registers, there are some additional registers within the drive which can be used to control the drive, monitor the drive's status. These registers can support write or read maximum 10 registers at a time.

Register address	Specification	R/W
9999*	Control command	W
10000*	Frequency command	W
10099*	State	R
10100*	Warning/Alarm code	R
10101	Output frequency (0~Fmax, unit: 0.1Hz)	R
10102	Output current (unit: 0.01A)	R
10103	Output voltage (unit: 1V)	R
10104	Output power (unit: 0.01kW)	R
10105	Motor speed (unit: 1rpm)	R
10106	DC bus voltage (unit: 1V)	R
10107	Reference	R
10108	Process PID Feedback	R

\* Reg. 9999 specification

Bit	Specification
Bit 7~0(run/stop control etc.)	0x00: No function 0x01: Run forward 0x02: Reverse 0x03: Jog 0x04: Jog reverse 0x05: Stop 0x06: Coast 0x07: Reset
Bit 11~8(Preset value select)	0000B:P0-30(Preset Value 0) 0001B: P0-31(Preset Value1) ... 1111B: P0-45(Preset Value 15)
Bit 13~12(Ramp time select)	00B: Ramp 1 01B: Ramp 2 10B: Ramp 3 11B: Ramp 4
Bit 14	Reserved
Bit 15	1B: Enable Bit8~13 function; 0B: Disable Bit8~13 function

\* Reg. 10000 specification

When using communication to control the drive, you can set the frequency directly by writing register 10000 . The register value is in the range of 0.00 ~ P5-08, unit 0.01Hz.

\* Reg. 10099 specification

Bit	Specification
Bit 0	0B: None; 1B: Warning
Bit 1	0B: None; 1B: Alarm
Bit 3~2	00B: Stop 01B: Run forward 10B: Reverse 11B: Reserved
Bit 7~4	Reserved
Bit 11~8	0000B: Using Preset Value 0 0001B: Using Preset Value 1 ... 1111B: Using Preset Value 15
Bit 15~12	Reserved

\* Reg. 10100specification

Register 10100 is used to read the drive warning/alarm code. For example: When the drive occurs A.48 alarm, the value of register 10100 is 48.

When the drive occurs u.24 warning, the value of register 10100 is 24.

## 5. Communication ratio values

The Communication data is expressed by hexadecimal in actual application and there is no radix point in hexadecimal. For example, if you want to set P5-08 = 61.5, 61.5 can be magnified by 10 times into 615. So hex 0x0267 (615) can be used to express 61.5.

A non-integer can be timed by a multiple to get an integer and the integer can be called communication ratio values.

The communication ratio values are referred to the radix point of the setting range of default value in the functional parameter list. If there are radix point n, then the communication ratio value m is  $10^n$ .

## 6. Error message

There may be errors in the communication process, for example, some parameters are read-only, but the PC/PLC sends a written directive, the drive will return an error message.

Error message data frame format is shown as the figure below:

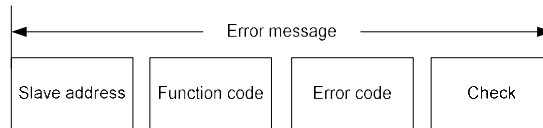

Error message function code = requirements function code + 0x80

Error code	Specification
0x01	Function code error, the drive does not support this kind of function code.
0x02	The register address is invalid.
0x03	The value exceeds the upper limit of the parameter
0x04	Operation error.

## 7. Examples

### 7.1 Read Holding Registers (0x03)

#### 7.1.1 Read Motor speed

Read parameter P9-04(Reg 903) to get the Motor speed.

Transmit: 01 03 03 87 00 01 34 67 (Hexadecimal)

Receive: 01 03 02 05 DC BA 8D (Hexadecimal)

Transmit data specification:

Field	Description
01	Address
03	Function
03 87	Register address: 903(0x0387)
00 01	The number of read registers is 1

Receive data specification:

Field	Description
01	Address
03	Function
02	The byte number of received data
05 DC	0x05DC converts to decimal number is 1500. So, the value of P9-04 is 1500RPM

#### 7.1.2 Read Drive Status, warning/alarm code and output frequency

Read multiple Registers 10099、10100、10101 to get all information.

Transmit: 01 03 27 73 00 03 FE A4 (Hexadecimal)

Receive: 01 03 06 00 04 00 00 01 F4 D0 A2 (Hexadecimal)

Transmit data specification:

Field	Description
01	Address
03	Function
2773	Register address: 10099(0x2773)
00 03	The number of read registers is 3
FE A4	CRC check

Receive data specification:

Field	Description
01	Address
03	Function
06	The byte number of received data
00 04 00 00 01 F4	The value of Reg. 10099 is 0x0004. Note: Bit 0 is 0B, that is No warning; Bit 1 is 0B, that is No Alarm; Bit 3~2 is 01B, that is Run forward; Bit 11~8 is 0000B, that is Using Preset Value 0; The value of Reg. 10100 is 0x0000(0). The drive doesn't have warning/ alarm, so it is 0. The value of Reg. 10101 is 0x01F4(500). So, the drive output frequency is 500/10=50.0Hz.

## 7.2 Write Single Register (0x06)

Set motor rated speed to 1430RPM.

Write P1-07(Reg 106)=1430.

Transmit: 01 06 00 6A 05 96 2A E8 (Hexadecimal)

Receive: 01 06 00 6A 05 96 2A E8 (Hexadecimal)

Transmit data specification:

Field	Description
01	Address
06	Function
00 6A	Register address of P1-07 is :107-1= 106(0x006A)
05 96	The value wants to set to P1-07 is 0x0596(1430)

Receive data specification:

Field	Description
01	Address
06	Function
00 6A	Register address of P1-07 is :107-1= 106(0x006A)
05 96	The value of P1-07 is 0x0596(1430)

## 7.3 Write Multiple Registers (0x10)

Start the drive and set Drive output frequency.

Write register 9999 to control the drive running and write register 10000 to set the drive output frequency.

Transmit: 01 10 27 0F 00 02 04 00 01 09 C4 5A 1D (Hexadecimal)

Receive: 01 10 27 0F 00 02 7B 7F (Hexadecimal)

Transmit data specification:

Field	Description
01	Address
10	Function
27 0F	Register address: 9999(0x270F)
00 02	The number of write registers is 2
04	The byte number of write data is 4
00 01 09 C4	Reg. 9999= 0x0001 Note: Bit 7~0 is 0x01, that is Run forward; Bit 11~8 is 0000B, that is Using Preset Value 0; Bit 13~12 is 00B, that is Using ramp 1; Bit 15 is 0B, that is Disable bit 13~8; Reg. 10000= 0x09C4(2500, So the Reference frequency is 2500 / 100 = 25.00Hz)

Receive data specification:

Field	Description
01	Address
10	Function
27 0F	Register address: 9999(0x270F)
00 02	The number of write registers is 2
01	Address