

TPD32-EV

DC SYSTEM DRIVES



GEFRAN
نماینده رسمی جفران ایتالیا در ایران

THE EXPERIENCE IN DC MOTOR CONTROL

000_827708

GEFRAN
BEYOND TECHNOLOGY

GEFRAN

BEYOND TECHNOLOGY

Over fifty years of experience, an organisation highly focused on the customer's needs and constant technological innovation make Gefran a benchmark in the design and production of sensors and components for industrial process automation and control.

Expertise, flexibility and process quality are the factors that distinguish Gefran in the production of integrated tools and systems for specific applications in various industrial fields, with consolidated know-how in the plastics, mobile hydraulics, heating and lift sectors.

Technology, innovation and versatility represent the catalogue's added value in addition to the ability to create specific application solutions in association with the world's leading machine manufacturers.

GEFRAN

نماینده رسمی جفران ایتالیا در ایران





Overview 4
 Introduction 4
 Identification Code..... 6

General Features..... 8
 Standard supply configuration..... 8
 Integrated System Technology 8
 Options..... 8
 Accessories..... 8
 Environmental conditions 8
 Standards and Marks..... 8
 Conditions d'environnement 10

Software..... 14

Converter Selection 18
 TPD32 EV-.../...-... Compact Case 18
 TPD32 EV-.../...-... External Bridge..... 19
 TPD32 EV-FC-..... 20
 TPD32-EV-CU-..... 20
 TPD32 EV-.../...-12P 21
 TPD32 EV-.../...-12S 21



Typical Connection Scheme..... 22
 TPD32 EV-..... 22
 TPD32 EV-FC 23
 TPD32 EV-CU 24
 Block diagram of exciter with external bridge 25
 12 Pulses DC Drives - TPD32 EV-...-12P and TPD32 EV-...-12S 26

Technical Specification..... 28
 Dimensions and Weights 28
 Converter Dissipation and Fan Flow 38

Ordering codes..... 40
 TPD32 EV - European Drive Rating 40
 TPD32 EV - European Drive Rating 41
 TPD32 EV-...-2B • American Drive Rating, UL compliant..... 42
 TPD32 EV-...-4B • American Drive Rating, UL compliant 43
 TPD32 EV-FC-... • Special versions for inductive loads, NOT UL compliant..... 44
 TPD32 EV-CU... • Control Unit for External bridge, UL compliant..... 44
 TPD32 EV-...-12P • 12 pulses DC drives , NOT UL compliant 45
 TPD32 EV-...-12S • 12 pulses DC drives , NOT UL compliant 45
 Power side fuses 46
 TPD32-EV-FC, Power side fuses 52
 Input Chokes 53
 EMC Filters..... 58
 Options 64
 Field Bus Interface 66
 Accessories..... 68
 Fuse holder 70



Introduction

Introduzione - Introduction - Einleitung - Introducción

 The TPD32 EV series of digital DC drive is a product of the ever growing technological demands of modern industrial systems, and draws on GEFran's years of experience in the field of DC motor speed control.

TPD32 EV is available in a wide range of motor power ratings and power supply types for solutions using both 2 quadrant and 4 quadrant operation.

Designed to minimise user system requirements, the TPD32 EV offers a range of functions and dedicated application packages to cover the most complex requirements of modern industrial automation systems.

A 12-impulse version of the converter is also available. This has two 6-impulse bridges with two different configurations: parallel (TPD32-EV-...-12P) or serial (TPD32-EV-...-12S).

• Serie TPD32 EV-...-2B

The power supply of the armature circuit is performed via a totally controlled three-phase Graetz bridge, while the field power supply uses a semi-controlled single-phase Graetz bridge.

This converter can therefore be used for 2 quadrant working and also allows performance of control in case of field weakening.

The field regulator allows a constant torque/power function.

• Serie TPD32 EV-...-4B

The power supply of the armature circuit is performed via a non-parallel totally controlled three-phase double Graetz bridge, while the field power supply uses a semi-controlled single-phase Graetz bridge.

This converter can therefore be used for 4 quadrant functioning and also allows performance in the case of field weakening control.

• Serie TPD32 EV-FC

Series of converters designed to supply highly inductive loads such as electromagnets, chokes, synchronous motor excitation circuits, galvanic applications, etc.

 La serie di convertitori digitali TPD32 EV nasce da un'esigenza sempre più tecnologica dei moderni sistemi industriali, mantenendo allo stesso tempo inalterata la pluriennale esperienza maturata da GEFran nel campo del controllo di velocità per i motori in corrente continua.

Studiato con l'obiettivo di razionalizzare al massimo le richieste di sistema dell'utenza, il TPD32 EV rende disponibili una serie di funzioni e pacchetti applicativi dedicati, in grado di coprire le più complesse esigenze dei moderni sistemi di automazione industriale.

Il convertitore è disponibile anche in versione a 12 impulsi, composto da due ponti a 6 impulsi collegati in due differenti configurazioni: parallelo (modello TPD32-EV-...-12P) o serie (TPD32-EV-...-12S).

• Serie TPD32 EV-...-2B

L'alimentazione del circuito di armatura è realizzata tramite un ponte di Graetz trifase totalcontrollato, mentre l'alimentazione del campo utilizza un ponte di Graetz monofase semicontrollato.

Questo convertitore è quindi utilizzabile per un funzionamento biquadrante e consente il controllo con indebolimento di campo.

Il regolatore di campo permette il funzionamento coppia/potenza costante.

• Serie TPD32 EV-...-4B

L'alimentazione del circuito di armatura è realizzata tramite un doppio ponte di Graetz trifase totalcontrollato in antiparallelo, mentre l'alimentazione del campo utilizza un ponte di Graetz monofase semicontrollato.

Questo convertitore è quindi utilizzabile per un funzionamento tetraquadrante e consente il controllo con indebolimento di campo.

Il regolatore di campo permette il funzionamento coppia/potenza costante.

• Serie TPD32 EV-FC

Serie di convertitori dedicata per alimentare carichi fortemente induttivi quali elettromagneti, induttanze, circuito di campo di eccitazione motori sincroni, applicazioni galvaniche, ecc.

 La série de convertisseurs numériques TPD32 EV est l'aboutissement d'une exigence encore plus technologique des systèmes industriels modernes, tout en conservant l'extraordinaire expérience que possède GEFran dans le secteur du contrôle des moteurs à courant continu.

Disponible dans une vaste gamme tant pour les puissances moteur que pour les tensions d'alimentation, ainsi que pour des applications fonctionnant à deux quadrants ou à quatre quadrants.

Étudié dans le but de rationaliser au maximum les exigences du système de l'utilisateur, le TPD32 EV offre une série de fonctions et d'applications spéciales, permettant de répondre aux exigences les plus complexes des systèmes modernes d'automatisation industrielle.

Le convertisseur est également disponible dans la version à 12 impulsions, constituée de deux ponts à 6 impulsions branchés dans deux configurations différentes : en parallèle (modèle TPD32-EV-...-12P) ou en série (TPD32-EV-...-12S).

• **Série TPD32 EV-...-2B**

L'alimentation du circuit d'armature est réalisée par un pont de Graetz triphasé totalement contrôlé, tandis que l'alimentation du champs utilise un pont de Graetz monophasé semi-contrôlé.

Ce convertisseur peut donc être utilisé pour un fonctionnement à deux quadrants et permet le contrôle avec affaiblissement de champ.

Le régulateur de champ permet le fonctionnement couple/puissance constant.

• **Série TPD32 EV-...-4B**

L'alimentation du circuit d'armature est réalisée par un double pont de Graetz triphasé totalement contrôlé en antiparallèle, tandis que l'alimentation du champ utilise un pont de Graetz monophasé semi-contrôlé. Ce convertisseur peut donc être utilisé pour un fonctionnement à quatre quadrants et permet le contrôle avec affaiblissement de champ.

Le régulateur de champ permet le fonctionnement couple/puissance constant.

• **Série TPD32 EV-FC**

Série de convertisseurs dédiée pour alimenter des charges fortement inductives telles que : électroaimants, inductances, circuit de champ d'excitation des moteurs synchrones, applications galvaniques, etc.

 Die Digitalstromrichterserie TPD32 EV entstand aus den ständig wachsenden technologischen Ansprüchen in modernen, industriellen Anlagen und setzt die langjährige Erfahrung von GEFran auf dem Gebiet der Drehzahlregelung von Gleichstrommotoren fort.

Erhältlich ist eine umfangreiche Produktpalette für ein weites Spektrum von Motorleistungen und Spannungsversorgungen, sowohl für Zwei- als auch für Vierquadrantbetrieb.

Die Serie TPD32 EV wurde mit dem Ziel entwickelt, die Anforderungen der Anwender so weit wie möglich zu integrieren.

Sie bietet zahlreiche Funktionen und spezielle Anwendungspakete, die den komplexesten Anwendungen moderner Automationssysteme für die Industrie gerecht werden.

Der Stromrichter ist auch in der Ausführung mit 12 Impulsen verfügbar, bestehend aus zwei Brücken mit 6 Impulsen, die in zwei unterschiedlichen Konfigurationen verbunden sind: parallel (Modell TPD32-EV-...-12P) oder Reihenschaltung (TPD32-EV-...-12S).

• **Série TPD32 EV-...-2B**

Die Speisung des Ankerkreises erfolgt über eine dreiphasige, komplett gesteuerte Graetzsche Brücke, während die Speisung des Feldes eine einphasige, halbgesteuerte Graetzsche Brücke verwendet. Dieser Stromrichter kann für den Zwei-Quadrantbetrieb eingesetzt werden und ermöglicht die Steuerung mit Feldabschwächung.

Der Feldregler ermöglicht den Betrieb mit konstantem Drehmoment/Leistung.

• **Série TPD32 EV-...-4B**

Die Speisung des Ankerkreises erfolgt über eine doppelte, dreiphasige Graetzsche Brücke, komplett gesteuert und in antiparalleler Schaltung, während die Speisung des Feldes eine einphasige, halbgesteuerte Graetzsche Brücke verwendet. Dieser Stromrichter ist daher für den Vierquadrantbetrieb verwendbar und ermöglicht die Steuerung mit Feldabschwächung.

Der Feldregler ermöglicht den Betrieb mit konstantem Drehmoment/Leistung.

• **Série TPD32 EV-FC**

Stromrichterserie zur Versorgung stark induktiver Lasten wie Elektromagneten, Drosseln, Erregungsfeld-Stromkreise, Synchronmotoren, galvanische Anwendungen usw.

 La serie de convertidores digitales TPD32 EV surge debido a la creciente exigencia tecnológica de los modernos sistemas industriales, manteniendo al mismo tiempo inalterada la gran experiencia de GEFran en el campo del control de velocidad para los motores de corriente continua.

Disponible en una amplia gama tanto de potencias de motor como de tensiones de alimentación, y para soluciones en funcionamiento a dos y a cuatro cuadrantes.

Estudiado con el objetivo de racionalizar al máximo las prestaciones del sistema, el TPD32 EV ofrece una serie de funciones integradas y paquetes de aplicaciones dedicadas, con el fin de cubrir las más complejas exigencias de los modernos sistemas de automatización industrial.

El convertidor también está disponible en una versión de 12 impulsos, que consta de puentes de 6 impulsos conectados en dos configuraciones diferentes: en paralelo (modelo TPD32-EV-...-12P) o en serie (TPD32-EV-...-12S).

• **Série TPD32 EV-...-2B**

La alimentación del circuito potencia se realiza mediante un puente de Graetz trifásico controlado totalmente, mientras que la alimentación del inducido emplea un puente de Graetz monofásico semicontrolado.

Así pues, este convertidor se puede utilizar para un funcionamiento con dos cuadrantes y permite el control con shuntaje del inducido.

El regulador del inducido permite el funcionamiento par/potencia constante.

• **Série TPD32 EV-...-4B**

La alimentación del estator se realiza mediante un doble puente de Graetz trifásico controlado totalmente en antiparalelo, mientras que la alimentación del rotor emplea un puente de Graetz monofásico semicontrolado.

Por lo tanto, este convertidor se puede utilizar para un funcionamiento con cuatro cuadrantes y permite el control con shuntaje de campo.

El regulador de campo permite el funcionamiento par/potencia constante.

• **Série TPD32 EV-FC**

Una serie específica de convertidores para cargas altamente inductivas como las electromagnéticas, inductancias, circuito de campo de excitación de motores síncronos, aplicaciones galvanicas, etc.

Identification Code

Codice di Identificazione
Code d'Identification
Identifikationscode
Siglas Identificación Producto

TPD32-EV

TPD32-EV -XXX / XXX -XX -XB -X -NA

	UL compliant	Conforme alla normativa UL	Conforme à la norme UL	UL-konform	De acuerdo con la normativa UL
	Frame: A, B, C, D, E	Forma costruttiva: A, B, C, D, E	Forme de construction : A, B, C, D, E	Bauform: A, B, C, D, E	Estructura: A, B, C, D, E
	Operation mode: 2B = 2 quadrant operation; 4B = 4 quadrant operation	Quadranti di funzionamento: 2B = biquadrante; 4B = tetraquadrante	Quadrants de fonctionnement: 2B = deux quadrants; 4B = quatre quadrants	Betriebsquadranten: 2B = Zweiquadrant, 4B = Vierquadrant	Cuadrantes de funcionamiento: 2B = bicuadrante; 4B = tetracuadrante
	Output rated current [A]	Corrente nominale in uscita [A]	Courant nominal de sortie [A]	Ausgangsstrom [A]	Corriente nominal de salida [A]
	Output rated continuous voltage [VDC]	Tensione continua nominale in uscita [VDC]	Tension continue nominale à la sortie [VDC]	Nenn-Gleichspannung im Ausgang [VDC]	Tensión continua nominal de salida [VDC]
	Input rated alternated voltage [VAC]	Tensione alternata nominale in ingresso [VAC]	Tension alternée nominale à l'entrée [VAC]	Nenn-Wechselspannung im Eingang [VAC]	Tensión alterna nominal de entrada [VAC]
	Converter type	Tipo di convertitore	Type de convertisseur	Stromrichter Typ	Tipo de convertidor

Esempio · Example · Exemple · Beispiel · Ejemplo

TPD32-EV -500 / 520 -1400 -4B -E

	Frame: E	Forma costruttiva: E	Forme de construction : E	Bauform: E	Estructura: E
	Operation mode: 4 quadrant operation	Quadranti di funzionamento: tetraquadrante	Quadrants de fonctionnement: quatre quadrants	Betriebsquadranten: Vierquadrant	Cuadrantes de funcionamiento: tetracuadrante
	Output rated current [A]	Corrente nominale in uscita [A]	Courant nominal de sortie [A]	Ausgangsstrom [A]	Corriente nominal de salida [A]
	Output rated continuous voltage [VDC]	Tensione continua nominale in uscita [VDC]	Tension continue nominale à la sortie [VDC]	Nenn-Gleichspannung im Ausgang [VDC]	Tensión continua nominal de salida [VDC]
	Input rated alternated voltage [VAC]	Tensione alternata nominale in ingresso [VAC]	Tension alternée nominale à l'entrée [VAC]	Nenn-Wechselspannung im Eingang [VAC]	Tensión alterna nominal de entrada [VAC]
	Converter type	Tipo di convertitore	Type de convertisseur	Stromrichter Typ	Tipo de convertidor

TPD32-EV-...-12P/12S

TPD32-EV -FC -XXX / XXX -XX -XB -X -XB

	Configuration (both includes two converters, master and slave unit): 12P = 12-Pulses Parallel configuration 12S = 12-Pulses Series configuration	Configurazioni (entrambe includono due convertitori: una unità master e una slave): 12P = Configurazione 12-Impulsi Parallelo 12S = Configurazione 12-Impulsi Serie	Configurations (toutes deux incluent deux convertisseurs : une unité master et une unité slave): 12P = Configuration 12-Impulsions en parallèle 12S = Configuration 12-Impulsions en série	Konfigurationen (beide umfassen zwei Stromrichter: eine Master- und eine Slave-Einheit): 12P = Konfiguration 12-Impulse Parallel 12S = Konfiguration 12-Impulse Serie	Configuraciones (ambas incluyen dos convertidores: una unidad maestra y una esclava): 12P = Configuración de 12 impulsos en paralelo 12S = Configuración de 12 impulsos en serie
	Frame: E	Forma costruttiva: E	Forme de construction : E	Bauform: E	Estructura: E
	Operation mode: 2B = 2 quadrant operation; 4B = 4 quadrant operation	Quadranti di funzionamento: 2B = biquadrante; 4B = tetraquadrante	Quadrants de fonctionnement: 2B = deux quadrants; 4B = quatre quadrants	Betriebsquadranten: 2B = Zweiquadrant, 4B = Vierquadrant	Cuadrantes de funcionamiento: 2B = bicuadrante; 4B = tetracuadrante
	Output rated current (A) for each power bridge	Corrente nominale in uscita per ogni ponte [A]	Courant nominal de sortie pour chaque pont [A]	Ausgangsstrom für jede Brücke [A]	Corriente nominal de salida para cada puente [A]
	Output rated continuous voltage [Vdc] for each power bridge	Tensione continua nominale in uscita per ogni ponte [VDC]	Tension continue nominale à la sortie pour chaque pont [VDC]	Nenn-Gleichspannung im Ausgang für jede Brücke [VDC]	Tensión continua nominal de salida para cada puente [VDC]
	Input rated alternated voltage [VAC]	Tensione alternata nominale in ingresso [VAC]	Tension alternée nominale à l'entrée [VAC]	Nenn-Wechselspannung im Eingang [VAC]	Tensión alterna nominal de entrada [VAC]
	Special converter for inductive loads	Convertitore speciale per carichi induttivi	Convertisseur spécial pour charges inductives	Spezialstromrichter für induktive Lasten	Convertidor especial para cargas inductivas

TPD32-EV-FC

TPD32-EV-FC -XXX / XXX -XX -XB -X

Frame: A, B	Forma costruttiva: A, B	Forme de construction : A, B	Bauform: A, B	Estructura: A, B
Operation mode: 2B = 2 quadrant operation; 4B = 4 quadrant operation	Quadranti di funzionamento: 2B = biquadrante; 4B = tetraquadrante	Quadrants de fonctionnement: 2B = deux quadrants; 4B = quatre quadrants	Betriebsquadranten: 2B = Zweiquadrant, 4B = Vierquadrant	Cuadrantes de funcionamiento: 2B = bicuadrante; 4B = tetracuadrante
Output rated current [A]	Corrente nominale in uscita [A]	Courant nominal de sortie [A]	Ausgangsstrom [A]	Corriente nominal de salida [A]
Output rated continuous voltage [Vdc]	Tensione continua nominale in uscita [Vdc]	Tension continue nominale à la sortie [Vdc]	Nenn-Gleichspannung im Ausgang [Vdc]	Tensión continua nominal de salida [Vdc]
Input rated alternated voltage [VAc]	Tensione alternata nominale in ingresso [VAc]	Tension alternée nominale à l'entrée [VAc]	Nenn-Wechselspannung im Eingang [VAc]	Tensión alterna nominal de entrada [VAc]
Special converter for inductive loads	Convertitore speciale per carichi induttivi	Convertisseur spécial pour charges inductives	Spezialstromrichter für induktive Lasten	Convertidor especial para cargas inductivas

Esempio · Example · Exemple · Beispiel · Ejemplo

TPD32-EV-FC -500 / 600 -20 -2B -A

Frame: A	Forma costruttiva: A	Forme de construction : A	Bauform: A	Estructura: A
Operation mode: 2B = 2 quadrant operation.	Quadranti di funzionamento: 2B = biquadrante.	Quadrants de fonctionnement: 2B = deux quadrants.	Betriebsquadranten: 2B = Zweiquadrant.	Cuadrantes de funcionamiento: 2B = bicuadrante.
Output rated current [A]	Corrente nominale in uscita [A]	Courant nominal de sortie [A]	Ausgangsstrom [A]	Corriente nominal de salida [A]
Output rated continuous voltage [Vdc]	Tensione continua nominale in uscita [Vdc]	Tension continue nominale à la sortie [Vdc]	Nenn-Gleichspannung im Ausgang [Vdc]	Tensión continua nominal de salida [Vdc]
Input rated alternated voltage [VAc]	Tensione alternata nominale in ingresso [VAc]	Tension alternée nominale à l'entrée [VAc]	Nenn-Wechselspannung im Eingang [VAc]	Tensión alterna nominal de entrada [VAc]
Special converter for inductive loads	Convertitore speciale per carichi induttivi	Convertisseur spécial pour charges inductives	Spezialstromrichter für induktive Lasten	Convertidor especial para cargas inductivas

نماینده رسمی جفران ایتالیا در ایران

TPD32-EV-CU

TPD32-EV-CU -XXX / XXX -THYX -XX

Field Output current : 20A, 40A	Corrente di campo in uscita: 20A, 40A	Courant de champ de sortie : 20A, 40A	Ausgangsfeldstrom: 20A, 40A	Corriente de campo de salida: 20A, 40A
External bridge control: THY1 = single SCR per branch THY2 = 2 parallel SCRs	Controllo ponte esterno: THY1 = singolo SCR per ramo THY2 = 2 SCR in parallelo	Contrôle du pont extérieur : THY1 = 1 SCR par branche THY2 = 2 SCR en parallèle	Steuerung externe Brücken: THY1 = ein einzelner SCR pro Zweig THY2 = 2 SCR in Parallelschaltung	Control puente externo: THY1 = un solo SCR por ramo THY2 = 2 SCR en paralelo
Output rated continuous voltage [Vdc]	Tensione continua nominale in uscita [Vdc]	Tension continue nominale à la sortie [Vdc]	Nenn-Gleichspannung im Ausgang [Vdc]	Tensión continua nominal de salida [Vdc]
Input rated alternated voltage [VAc]	Tensione alternata nominale in ingresso [VAc]	Tension alternée nominale à l'entrée [VAc]	Nenn-Wechselspannung im Eingang [VAc]	Tensión alterna nominal de entrada [VAc]
External bridge control unit	Unità di controllo Ponti Esterni	Unité de contrôle des ponts extérieurs	Steuereinheit Externe Brücken	Unidad de control puentes externos

Esempio · Example · Exemple · Beispiel · Ejemplo

TPD32-EV-CU -230 / 500 -THY1 -40

Field Output current : 40A	Corrente di campo in uscita: 40A	Courant de champ de sortie : 40A	Ausgangsfeldstrom: 40A	Corriente de campo de salida: 40A
External bridge control: THY1 = single SCR per branch	Controllo ponte esterno: THY1 = singolo ponte	Contrôle du pont extérieur : THY1 = 1 SCR par branche	Steuerung externe Brücken: THY1 = ein einzelner SCR pro Zweig	Control puente externo: THY1 = un solo SCR por ramo
Output rated continuous voltage [Vdc]	Tensione continua nominale in uscita [Vdc]	Tension continue nominale à la sortie [Vdc]	Nenn-Gleichspannung im Ausgang [Vdc]	Tensión continua nominal de salida [Vdc]
Input rated alternated voltage [VAc]	Tensione alternata nominale in ingresso [VAc]	Tension alternée nominale à l'entrée [VAc]	Nenn-Wechselspannung im Eingang [VAc]	Tensión alterna nominal de entrada [VAc]
External bridge control unit	Unità di controllo Ponti Esterni	Unité de contrôle des ponts extérieurs	Steuereinheit Externe Brücken	Unidad de control puentes externos

 General Features

Three-phase power circuit (U/V/W)

TPD32 EV-500/... :

- 230 VAC ±10%, 50/60Hz ±5%
- 400 VAC ±10%, 50/60Hz ±5%
- 440 VAC ±10%, 50/60Hz ±5%
- 460 VAC ±10%, 50/60Hz ±5%
- 480 VAC ±10%, 50/60Hz ±5%
- 500 VAC ±10%, 50/60Hz ±5%
- 2 quadrant (...-2B): from 20A up to 3300A
- 4 quadrant (...-4B): from 20A up to 3300A

TPD32 EV-575/... (*):

- 230 VAC ±10%, 50/60Hz ±5%
- 400 VAC ±10%, 50/60Hz ±5%
- 440 VAC ±10%, 50/60Hz ±5%
- 460 VAC ±10%, 50/60Hz ±5%
- 480 VAC ±10%, 50/60Hz ±5%
- 500 VAC ±10%, 50/60Hz ±5%
- 575 VAC ±10%, 50/60Hz ±5%
- 2 quadrant (...-2B): from 280A up to 2300A
- 4 quadrant (...-4B): from 280A up to 2300A

TPD32 EV-690/... (*):

- 230 VAC ±10%, 50/60Hz ±5%
- 400 VAC ±10%, 50/60Hz ±5%
- 440 VAC ±10%, 50/60Hz ±5%
- 460 VAC ±10%, 50/60Hz ±5%
- 480 VAC ±10%, 50/60Hz ±5%
- 500 VAC ±10%, 50/60Hz ±5%
- 575 VAC ±10%, 50/60Hz ±5%
- 690 VAC ±10%, 50/60Hz ±5%
- 2 quadrant (...-2B): from 560A up to 3300A
- 4 quadrant (...-4B): from 560A up to 3300A

TPD32 EV-CU-230/500-...:

- 230 VAC ... 500 VAC ±10%, 50/60Hz ±5%

TPD32 EV-CU-575/690-...:

- 575 VAC ... 690 VAC ±10%, 50/60Hz ±5%

TPD32 EV-FC-200/...:

- 60 VAC ... 200 VAC ±10%, 50/60Hz ±5%

TPD32 EV-FC-500/...:

- 230 VAC ... 500 VAC ±10%, 50/60Hz ±5%

Single-phase field circuit (U1/V1) (*)

- 230 VAC ±10%, 50/60Hz ±5%
- 400 VAC ±10%, 50/60Hz ±5%
- 460 VAC ±10%, 50/60Hz ±5%

Single-phase regulation circuit (U2/V2)

- 115 VAC ±15%, 50/60Hz ±5%
- 230 VAC ±15%, 50/60Hz ±5%

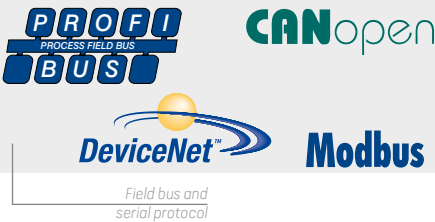

Standard supply configuration

- Speed feedback via tachogenerator and/or digital or sinusoidal encoder;
- Digital I/O logic control in PNP and/or NPN configuration;
- Analog inputs: 3 Differential, 12 programmable Bits, selectable for ±10 VDC, 0-20mA, 0-10 VDC, 4-20mA;
- 2 Analog outputs (±10Vdc);
- 2 encoder inputs: sinusoidal (power supply at 5 V) and digital (power supply at 5V or 24 V);
- 1 Tachogenerator input;
- 8 Digital inputs (4 fixed + programmable);
- 4 programmable digital outputs;
- Relay outputs: 1 Drive OK normally closed contact, 1 programmable normally closed contact;
- 1 Motor thermistor input;
- RS485 Serial line (Modbus RTU protocol);
- Programmable overload up to 200%;
- Interfacing with fieldbus protocol as: ProfibusDP, CANopen and DeviceNet;
- LED diagnostics module.

Integrated System Technology

- Quick start up;
- Autotuning of the speed and current (*) regulators ;
- 5 Independent programmable Multi-ramps;
- Programmable Linear and "S" shaped ramps;
- Seven Programmable Multispeeds;
- Independent regulation of the Min/Max speed for each direction sense of rotation;
- Current limitation in accordance with the speed;
- Adaptive gains of the speed regulator;
- Independent management of the integral gain at zero speed;
- Programmable overload control;
- Jog function;
- Motorpotentiometer function;
- I²t motor protection;
- PID function block;
- Servodiameter control function;
- "Speed Draw" function;
- "Autocapture" function (Flying restart);
- "Droop" function.

Options

- Programming keypad KB;
- I/O expansion card TBO-32;
- Profibus interface SBI-PDP-32;
- DeviceNet interface SBI-DN;
- CANopen interface SBI-COP;
- Programmable application card APC300;
- Supplementary encoders management DEII.

Accessories

- Dedicated EMC filters (in accordance with EN61800-3);
- Input choke (standardised for the whole line);
- Programming remote keypad kit;
- RS485 serial line kit for direct PC communication.

Environmental conditions

- Protection degree: IP20 up to 1000A (...-2B) and 1050A (...-4B), IP20/IP00 for bigger powers.
- Operating temperature: From 0°C (32°F) to 40°C (104°F), from + 40°C (104°F) to +50°C (122°F) with derating.
- Storage temperature: -25°C...+55°C (13°F to 131°F), Class 1K4 - EN50178
- Humidity: From 5% to 85%, relative humidity (without condensation) or ice formation (Class 3K3 under EN50178).
- Altitude: Up to 1000 metres above sea level; above this level the current must be reduced by 1.2% per 100 metre increase.

Attention: The DC drive is suitable for use under the environmental service conditions (climate, mechanical, pollution, etc.) defined as usual service conditions according to EN61800-1.

Standards and Marks

- CE: Complies with the EC directive concerning low voltage equipment (Directives LVD 2014/35/EU, EMC 2014/30/EU, RoHs 2011/65/EU)
- UL, cUL: Complies with directives for the American and Canadian market (for TPD32-EV, TPD32-EV-...-NA, TPD32-EV-CU and TPD32-EV-FC models. Frame E, sizes TPD32-EV-690/... and TPD32-EV_12P/12S not included).
- EMC: Complies with the EC directive - EN 61800-3 concerning electromagnetic compatibility with the use of optional filters.

(*) Except the TPD32-EV-FC-... series

Caratteristiche Generali

Circuito di potenza (U/V/W) – Trifase

TPD32 EV-500/... :

230 VAC ±10%, 50/60Hz ±5%
 400 VAC ±10%, 50/60Hz ±5%
 440 VAC ±10%, 50/60Hz ±5%
 460 VAC ±10%, 50/60Hz ±5%
 480 VAC ±10%, 50/60Hz ±5%
 500 VAC ±10%, 50/60Hz ±5%
 - biquadrante (...-2B): da 20A a 3300A
 - tetraquadrante (...-4B): da 20A a 3300A

TPD32 EV-575/... (*) :

230 VAC ±10%, 50/60Hz ±5%
 400 VAC ±10%, 50/60Hz ±5%
 440 VAC ±10%, 50/60Hz ±5%
 460 VAC ±10%, 50/60Hz ±5%
 480 VAC ±10%, 50/60Hz ±5%
 500 VAC ±10%, 50/60Hz ±5%
 575 VAC ±10%, 50/60Hz ±5%
 - biquadrante (...-2B): da 280A a 2300A
 - tetraquadrante (...-4B): da 280A a 2300A

TPD32 EV-690/... (*) :

230 VAC ±10%, 50/60Hz ±5%
 400 VAC ±10%, 50/60Hz ±5%
 440 VAC ±10%, 50/60Hz ±5%
 460 VAC ±10%, 50/60Hz ±5%
 480 VAC ±10%, 50/60Hz ±5%
 500 VAC ±10%, 50/60Hz ±5%
 575 VAC ±10%, 50/60Hz ±5%
 690 VAC ±10%, 50/60Hz ±5%
 - biquadrante (...-2B): da 560A a 3300A
 - tetraquadrante (...-4B): da 560A a 3300A

TPD32 EV-CU-230/500-... :

230 VAC ... 500 VAC ±10%, 50/60Hz ±5%

TPD32 EV-CU-575/690-... :

575 VAC ... 690 VAC ±10%, 50/60Hz ±5%

TPD32 EV-FC-200/... :

60 VAC ... 200 VAC ±10%, 50/60Hz ±5%

TPD32 EV-FC-500/... :

230 VAC ... 500 VAC ±10%, 50/60Hz ±5%

Circuito di campo (U1/V1) – Monofase (*)

230 VAC ±10%, 50/60Hz ±5%
 400 VAC ±10%, 50/60Hz ±5%
 460 VAC ±10%, 50/60Hz ±5%

Circuito della regolazione (U2/V2) – Monofase

115 VAC ±15%, 50/60Hz ±5%
 230 VAC ±15%, 50/60Hz ±5%

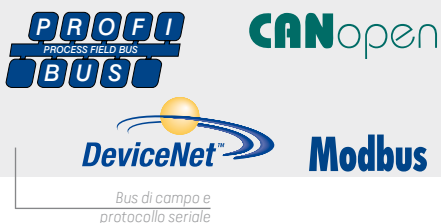

Configurazione Standard

- Retroazione di velocità tramite dinamo tachimetrica e/o encoder digitale o sinusoidale;
- Comandi I/O digitali in logica PNP e/o NPN;
- Ingressi analogici: 3 Differenziali, 12 Bit programmabili, selezionabili per ±10 VDC, 0 - 20 mA, 0 - 10 VDC, 4 - 20 mA;
- 2 Uscite analogiche ±10Vdc;
- 2 Ingressi encoder: sinusoidale (alimentazione 5 V) e digitale (alimentazione 5V o 24 V);
- 1 Ingresso dinamo tachimetrica;
- 8 Ingressi digitali (4 fissi + 4 programmabili);
- 4 Uscite digitali programmabili;
- Uscite a relè: 1 contatto per drive OK (normalmente chiuso), 1 contatto programmabile normalmente chiuso;
- 1 Ingresso termistore motore;
- Linea seriale RS485 (protocollo Modbus RTU);
- Sovraccarico programmabile fino al 200%;
- Interfacciamento ai più comuni bs di campo: ProfibusDP, CANopen e DeviceNet;
- Modulo di diagnostica a led.

Tecnologia di sistema integrata

- Autotaratura dell'anello di corrente (*) e velocità;
- 5 Rampe indipendenti e programmabili;
- Rampa Lineare e "S" programmabile;
- 7 Multi velocità programmabili;
- Limiti di velocità Min/Max con regolazioni indipendenti per ogni direzione di velocità;
- Limitazione corrente in funzione della velocità;
- Guadagni adattativi del regolatore di velocità;
- Gestione indipendente del guadagno integrale a velocità zero;
- Controllo programmabile del sovraccarico;
- Funzione di marcia Jog;
- Arresto controllato e ripartenza automatica motore;
- Funzione Motopotenziometro;
- Protezione I²t motore;
- Funzione PID;
- Funzione Servodiametro;
- Funzione "Speed Draw";
- Funzione "Autocapture" (riaggancio al volo);
- Funzione "Droop".

Opzioni

- Tastierino di programmazione KB
- Espansione Ingressi/Uscite TBO-32
- Interfaccia Profibus SBI-PDP-32
- Interfaccia DeviceNet SBI-DN
- Interfaccia CANopen SBI-COP
- Scheda applicativa programmabile APC300
- Scheda per gestione encoder supplementari DEII

Accessori

- Filtri EMC dedicati (in conformità con la Direttiva Europea EN 61800-3);
- Induttanze di Ingresso (normalizzate tutta la gamma);
- Kit per l'installazione a distanza della tastiera di programmazione;
- Kit linea seriale RS485 per collegamento con PC.

Condizioni Ambientali

- Alloggiamento: IP20 fino a 1000A (...-2B) e 1050A (...-4B), IP20/IP00 per taglie superiori.
 Temperatura di esercizio: Da 0°C a 40 °C, da + 40 °C a +50 °C con derating.
 Temperatura di immagazzinaggio: -25°C...+55°C (Classe 1K4 - EN50178).
 Umidità: Da 5% a 85%, umidità relativa (senza condensa) o formazione di ghiaccio (classe 3K3 in accordo a EN50178).
 Altitudine: Fino a 1000 metri s.l.m.; oltre a questo valore, la corrente deve essere ridotta del 1,2% ogni 100 metri di incremento.

Importante: Il convertitore opererà sotto le condizioni di servizio ambientali (clima, meccaniche, inquinamento, ...) definite nella EN61800-1 per quanto riguarda le "usual service conditions".

Norme e Marchi

- CE: Conforme alla direttiva CE sugli apparecchi a bassa tensione (Direttive LVD 2014/35/EU, EMC 2014/30/UE, RoHs 2011/65/EU).
- UL, cUL: Conforme alle direttive per il mercato Americano e Canadese (per i modelli TPD32-EV, TPD32-EV-...-NA, TPD32-EV-CU e TPD32-EV-FC. Non inclusi frame E, TPD32-EV-690/... e TPD32-EV_12P/12S).
- EMC: Conforme alla direttiva CE - EN 61800-3, sulla compatibilità elettromagnetica con l'impiego dei filtri opzionali.

(*) Esclusa serie TPD32-EV-FC-...

Circuit de puissance (U/V/W) – Triphasé

TPD32 EV-500/... :

230 VAC ±10%, 50/60Hz ±5%
 400 VAC ±10%, 50/60Hz ±5%
 440 VAC ±10%, 50/60Hz ±5%
 460 VAC ±10%, 50/60Hz ±5%
 480 VAC ±10%, 50/60Hz ±5%
 500 VAC ±10%, 50/60Hz ±5%
 - deux quadrants (...-2B): de 20A à 3300A
 - quatre quadrants (...-4B): de 20A à 3300A

TPD32 EV-575/... (*) :

230 VAC ±10%, 50/60Hz ±5%
 400 VAC ±10%, 50/60Hz ±5%
 440 VAC ±10%, 50/60Hz ±5%
 460 VAC ±10%, 50/60Hz ±5%
 480 VAC ±10%, 50/60Hz ±5%
 500 VAC ±10%, 50/60Hz ±5%
 575 VAC ±10%, 50/60Hz ±5%
 - deux quadrants (...-2B): de 280A à 2300A
 - quatre quadrants (...-4B): de 280A à 2300A

TPD32 EV-690/... (*) :

230 VAC ±10%, 50/60Hz ±5%
 400 VAC ±10%, 50/60Hz ±5%
 440 VAC ±10%, 50/60Hz ±5%
 460 VAC ±10%, 50/60Hz ±5%
 480 VAC ±10%, 50/60Hz ±5%
 500 VAC ±10%, 50/60Hz ±5%
 575 VAC ±10%, 50/60Hz ±5%
 690 VAC ±10%, 50/60Hz ±5%
 - deux quadrants (...-2B): de 560A à 3300A
 - quatre quadrants (...-4B): de 560A à 3300A

TPD32 EV-CU-230/500-... :

230 VAC ... 500 VAC ±10%, 50/60Hz ±5%

TPD32 EV-CU-575/690-... :

575 VAC ... 690 VAC ±10%, 50/60Hz ±5%

TPD32 EV-FC-200/... :

60 VAC ... 200 VAC ±10%, 50/60Hz ±5%

TPD32 EV-FC-500/... :

230 VAC ... 500 VAC ±10%, 50/60Hz ±5%

Circuit de champs (U1/V1) – Monophasé (*)

230 VAC ±10%, 50/60Hz ±5%
 400 VAC ±10%, 50/60Hz ±5%
 460 VAC ±10%, 50/60Hz ±5%

Circuit de la régulation (U2/V2) – Monophasé

115 VAC ±15%, 50/60Hz ±5%
 230 VAC ±15%, 50/60Hz ±5%



Configuration en fourniture standard

- Retour de vitesse par dynamo tachymétrique et/ou codeur digital ou sinusoïdal;
- Commande par E/S numériques à logique PNP et/ou NPN;
- Entrées analogiques: 3 Différentiels, 12 Bits programmables, sélectionnables pour ±10 VCC, 0-20 mA, 0-10 Vcc, 4-20 mA;
- 2 Sorties analogiques ±10Vcc;
- 2 Entrées codeur: sinusoïdal (alimentation 5 V) et digital (alimentation 5V ou 24 V);
- 1 Entrée dynamo tachymétrique;
- 8 Entrées digitales (4fixes + 4 programmables);
- 4 sorties digitales programmables;
- Sorties à relais: 1 contact pour variateur OK (normalement fermé), 1 contact programmable normalement fermé;
- 1 Entrée sonde thermique moteur;
- Liaison série RS485 (protocole Modbus RTU);
- Surcharge programmable jusqu'à 200%;
- Interface avec les bus de terrain les plus utilisés: ProfibusDP, CANopen et DeviceNet;
- Module de diagnostic à led.

Technologie système intégrée

- Calibrage automatique de la boucle de courant (*) et de vitesse ;
- 5 Rampes indépendantes et programmables ;
- Rampe Linéaire et en "S" programmable ;
- 7 Multi vitesses programmables ;
- Limites de vitesse Mini/Maxi avec régulations indépendantes pour chaque direction de vitesse;
- Limitation du courant en fonction de la vitesse;
- Gains d'adaptation du régulateur de vitesse;
- Gestion indépendante du gain intégral à vitesse zéro;
- Contrôle programmable de la surcharge;
- Fonction de marche Jog;
- Arrêt contrôlé et redémarrage automatique du moteur;
- Fonction Moto-potentiomètre;
- Protection I²t moteur;
- Fonction PID;
- Fonction Servo-diamètre;
- Fonction "Speed Draw";
- Fonction "reprise à la volée";
- Fonction "Droop".

Options

- Clavier de paramétrage KB;
- Carte d'extension des entrées/sorties TBO-32;
- Interface Profibus SBI-PDP-32;
- Interface DeviceNet SBI-DN;
- Interface CANopen SBI-COP;
- Carte d'application programmable APC300;
- Carte de gestion des codeurs supplémentaires DEII.

Accessoires

- Filtrés CEM dédiés (conformes aux Directives Européennes EN61800-3) ;
- Inductances d'entrée (normalisées pour toute la gamme) ;
- Kit pour installation à distance de la console de programmation ;
- Kit ligne série RS485 pour raccordement avec un ordinateur (PC).

Conditions d'environnement

Degré de protection: IP20 jusqu'à 1000A (...-2B) et 1050A (...-4B), IP20/IP00 pour les calibres supérieurs.
 Température de service : De 0°C à 40 °C, de + 40 °C à +50 °C avec déclassement.
 Température de stockage : -25°C...+55°C (Classe 1K4 - EN50178).
 Humidité : De 5% à 85%, humidité relative (sans condensation) ou formation de glace (classe 3K3 conformément à la norme EN50178).
 Altitude : Jusqu'à 1000 mètres au-dessus du niveau de la mer ; au-delà de cette valeur, le courant doit être diminué de 1,2% tous les 100 mètres supplémentaires.

Important Le drive fonctionnera dans les conditions de service ambiantes (climatiques, mécaniques, pollution, etc.) définies dans la section de la norme EN61800-1 traitant des « Conditions de service habituelles ».

Normes et marques

CE: Conformes à la directive CE sur les appareils en basse tension (Directives LVD 2014/35/EU, EMC 2014/30/EU, RoHS 2011/65/EU).
 UL, cUL: Conformes aux directives pour le marché Américain et Canadien (Pour modèles TPD32-EV, TPD32-EV-...-NA, TPD32-EV-CU et TPD32-EV-FC. Forme de construction E, grandeurs TPD32-EV-690/... et TPD32-EV_12P/12S non incluses).
 EMC: Conformes à la directive CE - EN 61800-3, concernant la compatibilité électromagnétique avec l'utilisation des filtres en option.

(*) Série TPD32-EV-FC-... exclue

 Allgemeine Merkmale

Leistungskreis (U/V/W) - dreiphasig

TPD32 EV-500/... :

230 VAC ±10%, 50/60Hz ±5%
 400 VAC ±10%, 50/60Hz ±5%
 440 VAC ±10%, 50/60Hz ±5%
 460 VAC ±10%, 50/60Hz ±5%
 480 VAC ±10%, 50/60Hz ±5%
 500 VAC ±10%, 50/60Hz ±5%
 - Zweiquadrant (...-2B): von 20A bis 3300A
 - Vierquadrant (...-4B): von 20A bis 3300A

TPD32 EV-575/... (*) :

230 VAC ±10%, 50/60Hz ±5%
 400 VAC ±10%, 50/60Hz ±5%
 440 VAC ±10%, 50/60Hz ±5%
 460 VAC ±10%, 50/60Hz ±5%
 480 VAC ±10%, 50/60Hz ±5%
 500 VAC ±10%, 50/60Hz ±5%
 575 VAC ±10%, 50/60Hz ±5%
 - Zweiquadrant (...-2B): von 280A bis 2300A
 - Vierquadrant (...-4B): von 280A bis 2300A

TPD32 EV-690/... (*) :

230 VAC ±10%, 50/60Hz ±5%
 400 VAC ±10%, 50/60Hz ±5%
 440 VAC ±10%, 50/60Hz ±5%
 460 VAC ±10%, 50/60Hz ±5%
 480 VAC ±10%, 50/60Hz ±5%
 500 VAC ±10%, 50/60Hz ±5%
 575 VAC ±10%, 50/60Hz ±5%
 690 VAC ±10%, 50/60Hz ±5%
 - Zweiquadrant (...-2B): von 560A bis 3300A
 - Vierquadrant (...-4B): von 560A bis 3300A

TPD32 EV-CU-230/500-... :

230 VAC ... 500 VAC ±10%, 50/60Hz ±5%

TPD32 EV-CU-575/690-... :

575 VAC ... 690 VAC ±10%, 50/60Hz ±5%

TPD32 EV-FC-200/... :

60 VAC ... 200 VAC ±10%, 50/60Hz ±5%

TPD32 EV-FC-500/... :

230 VAC ... 500 VAC ±10%, 50/60Hz ±5%

Feldkreis (U1/V1) - einphasig (*)

230 VAC ±10%, 50/60Hz ±5%
 400 VAC ±10%, 50/60Hz ±5%
 460 VAC ±10%, 50/60Hz ±5%

Steuerkreis (U2/V2) - einphasig

115 VAC ±15%, 50/60Hz ±5%
 230 VAC ±15%, 50/60Hz ±5%

Konfiguration Standardlieferung

- Drehzahlrückführung über Tacho-Dynamo und/oder Digital- oder Sinusencoder;
- Digitale I/O-Befehle mit PNP- und/oder NPN-Logik;
- Analogeingänge: 3 Differentiale, 12 Bit programmierbar, wählbar für ±10 VDC, 0...10 VDC, 4...20 mA;
- 2 Analogausgänge ±10 VDC;
- 2 Encodereingänge: Sinusencoder (Speisung 5 V) und Digitalencoder (Speisung 5V oder 24 V);
- 1 Tacho-Dynamo-Eingang;
- 8 Digitaleingänge (4 fixe + 4 programmierbare);
- 4 Digitalausgänge, programmierbar;
- Relaisausgänge: 1 Kontakt für Antrieb OK (Öffner), 1 programmierbarer Kontakt (Öffner);
- 1 Motorthermistor-Eingang;
- Serielle RS485 Leitung (Modbus RTU-Protokoll);
- Bis 200 % programmierbare Überlast;
- Anschluss an die gebräuchlichsten Feldbusse: ProfibusDP, CANopen und DeviceNet;
- LED-Diagnosemodul.

Integrierte Systemtechnologie

- Selbstadaption von Strom- (*) und Drehzahlregelkreis;
- 5 unabhängige, programmierbare Rampen;
- Programmierbare lineare und "S"-förmige Rampe;
- 7 programmierbare Drehzahlen;
- Min/Max Drehzahlbegrenzungen für jede Drehzahlrichtung;
- Strombegrenzung als Funktion der Drehzahl;
- Bereichsweise Anpassung der Drehzahlreglerverstärkungen;
- Separate Integralverstärkung bei Nulldrehzahl;
- Programmierbares Überlastverhalten;
- Funktion Tippbetrieb;
- Gesteuerter Motorhalt und automatischer Wiederanlauf;
- Funktion Motorpotentiometer;
- I²t Motorschutz;
- PID-Funktion zusätzlich frei programmierbar;
- Funktion Wicklerregelung;
- "Speed Draw" Funktion (Streckung von Material);
- "Autocapture" Funktion (Aufschalten auf drehenden Motor);
- "Droop" Funktion (bei mechanisch gekoppelten Motoren).

Optionen

- Programmier-Bedieneinheit KB;
- Erweiterung Eingänge/Ausgänge TBO-32;
- Profibus-Schnittstelle SBI-PDP-32;
- DeviceNet-Schnittstelle SBI-DN;
- CANopen-Schnittstelle SBI-COP;
- Programmierbare Anwendungskarte APC300;
- Erweiterungskarte für zusätzliche Encoder DEII.

Zubehör

- Spezielle EMV-Filter (gemäß EG-Richtlinie - EN61800-3);
- Eingangsnetzdröseln (für die gesamte Produktpalette genormt);
- Montagesatz für externe Installation der Programmier-Bedieneinheit;
- Montagesatz serielle RS485 Leitung für PC-Anschluss.

Umgebungsbedingungen

- Schutzgrad: IP20 bis 1000 A (...-2B) und 1050 A (...-4B), IP20/IP00 für größere Geräte.
 Betriebstemperatur: Von 0° C bis 40° C , von + 40° C bis +50° C mit Leistungsreduktion.
 Lagerungstemperatur: -25° C...+55° C (Klasse 1K4 - EN50178).
 Feuchtigkeit: Von 5 % bis 85 %, relative Feuchtigkeit (ohne Betauung) oder Eisbildung (Klasse 3K3 entsprechend EN50178).
 Installationshöhe: Bis zu 1000 Metern ü.d.M.; über diesem Wert muss der Strom pro 100 Höhenmeter um 1,2 % verringert werden.

Wichtig: Der Stromrichter arbeitet unter den laut EN61800-1 in Bezug auf die "usual service conditions" festgelegten Umgebungsbedingungen für den Betrieb (Klima, mechanische Bedingungen, Verschmutzung, ...).

Normen und Marken

- CE: Entspricht der EG-Richtlinie über Geräte mit Niederspannung (Richtlinien LVD 2014/35/EU, EMC 2014/30/EU, RoHS 2011/65/EU).
 UL, cUL: Entspricht den Richtlinien für den amerikanischen und kanadischen Markt (Für Modelle TPD32-EV, TPD32-EV-...-NA, TPD32-EV-CU und TPD32-EV-FC. Bauform E, Baugrößen TPD32-EV-690/... und TPD32-EV_12P/12S nicht inklusive).
 EMC: Entspricht der EG-Richtlinie - EN 61800-3 über die elektromagnetische Verträglichkeit mit dem Einsatz optionaler Filter.

(*) Unter Ausnahme der Serie TPD32-EV-FC-...





Circuito de potencia (U/V/W) – Trifásico

TPD32 EV-500/... :

230 VAC ±10%, 50/60Hz ±5%
 400 VAC ±10%, 50/60Hz ±5%
 440 VAC ±10%, 50/60Hz ±5%
 460 VAC ±10%, 50/60Hz ±5%
 480 VAC ±10%, 50/60Hz ±5%
 500 VAC ±10%, 50/60Hz ±5%
 - dos cuadrantes (...-2B): de 20A a 3300A
 - cuatro cuadrantes (...-4B): de 20A a 3300A

TPD32 EV-575/... (*):

230 VAC ±10%, 50/60Hz ±5%
 400 VAC ±10%, 50/60Hz ±5%
 440 VAC ±10%, 50/60Hz ±5%
 460 VAC ±10%, 50/60Hz ±5%
 480 VAC ±10%, 50/60Hz ±5%
 500 VAC ±10%, 50/60Hz ±5%
 575 VAC ±10%, 50/60Hz ±5%
 - dos cuadrantes (...-2B): de 280A a 2300A
 - cuatro cuadrantes (...-4B): de 280A a 2300A

TPD32 EV-690/... (*):

230 VAC ±10%, 50/60Hz ±5%
 400 VAC ±10%, 50/60Hz ±5%
 440 VAC ±10%, 50/60Hz ±5%
 460 VAC ±10%, 50/60Hz ±5%
 480 VAC ±10%, 50/60Hz ±5%
 500 VAC ±10%, 50/60Hz ±5%
 575 VAC ±10%, 50/60Hz ±5%
 690 VAC ±10%, 50/60Hz ±5%
 - dos cuadrantes (...-2B): de 560A a 3300A
 - cuatro cuadrantes (...-4B): de 560A a 3300A

TPD32 EV-CU-230/500-...:

230 VAC ... 500 VAC ±10%, 50/60Hz ±5%

TPD32 EV-CU-575/690-...:

575 VAC ... 690 VAC ±10%, 50/60Hz ±5%

TPD32 EV-FC-200/...:

60 VAC ... 200 VAC ±10%, 50/60Hz ±5%

TPD32 EV-FC-500/...:

230 VAC ... 500 VAC ±10%, 50/60Hz ±5%

Circuito de campo (U1/V1) – Monofásico (*)

230 VAC ±10%, 50/60Hz ±5%
 400 VAC ±10%, 50/60Hz ±5%
 460 VAC ±10%, 50/60Hz ±5%

Circuito de la regulación (U2/V2) – Monofásico

115 VAC ±15%, 50/60Hz ±5%
 230 VAC ±15%, 50/60Hz ±5%



Standard supply configuration

- Realimentación de velocidad a través de dinamo taquimétrica y/o encoder digital o sinusoidal
- Lógica de los comandos E/S digitales PNP y/o NPN;
- Entradas analógicas: 3 diferenciales, 12 bits programables, seleccionables para ±10 VDC, 0 - 20 mA, 0 - 10 VDC, 4 - 20 mA;
- 2 Salidas analógicas ±10Vdc;
- 2 entradas encoder: sinusoidal (alimentación 5 V) y digital (alimentación 5V o 24 V);
- 1 Entrada de dinamo taquimétrica;
- 8 Entradas digitales (4 fijas + 4 programables);
- 4 salidas digitales programables;
- Salidas de relé: 1 contacto por unidad OK (normalmente cerrado), 1 contacto programable normalmente cerrado;
- 1 Entrada termistor motor;
- Línea serie RS485 (protocolo Modbus RTU);
- Sobrecarga programable hasta el 200%;
- Interfaz para los buses de campo más comunes: ProfibusDP, CANopen e DeviceNet;
- Módulo de diagnóstico por leds.

Tecnología de sistema integrada

- Autocalibración del bucle de corriente (*) y velocidad;
- 5 Rampas independientes y programables;
- Rampa Lineal y en "S" programables;
- 7 Multivelocidades programables;
- Límites de velocidad Mín./Máx. con regulación: independiente para cada dirección de la velocidad;
- Limitación de corriente en función de la velocidad;
- Ganancias adaptativas del regulador de velocidad;
- Gestión independiente de la ganancia integral a velocidad;
- Control programable de la sobrecarga;
- Función de marcha Jog;
- Parada controlada y rearmado automático del motor;
- Función Motopotenciómetro;
- Protección I²t del motor;
- Función PID;
- Función Servodiámetro;
- Función "Speed Draw";
- Función "Autocapture" (reenganche al vuelo);
- Función "Droop".

Opciones

- Teclado de programación KB;
- Ampliaciones Entrada/Salida TBO-32;
- Interfaz Profibus SBI-PDP-32;
- Interfaz DeviceNet SBI-DN;
- Interfaz CANopen SBI-COP;
- Placa aplicativa programable APC300;
- Placa para la gestión del encoder suplementario DEII.

Accesorios

- Filtros EMC dedicados (en cumplimiento de la Directiva Europea EN 61800-3);
- Inductancia de Entrada (normalizada en toda la gama);
- Kit para teclado de programación remota;
- Kit línea serie RS485 para conexión con PC.

Condiciones ambientales

Grado de protección: IP20 hasta 1000A (...-2B) y 1050A (...-4B), IP20/IP00 para cortes superiores.
 Temperatura de ejercicio: De 0°C a 40 °C, de + 40 °C a +50 °C con reducción.
 Temperatura de almacenamiento: -25°C...+55°C (Clase 1K4 - EN50178).
 Humedad: Del 5% al 85%, humedad relativa (sin condensación) o formación de hielo (clase 3K3 en cumplimiento de la normativa EN50178).
 Altura: Hasta 1000 metros s.l.m.; para otros valores, la intensidad debe reducirse en 1,2% por cada 100 metros de aumento.

Importante: el convertidor funcionará bajo las condiciones de servicio ambientales (clima, mecánica, contaminación...) definidas en la EN61800-1 con respecto a las "usual service conditions".

Normas y marcas

CE: De acuerdo con la directiva CE en los equipos de baja tensión (Directivas LVD 2014/35/EU, EMC 2014/30/EU, RoHS 2011/65/EU).
 UL, cUL: En cumplimiento de las directivas para el mercado Americano y Canadiense (para los modelos TPD32-EV, TPD32-EV-...-NA, TPD32-EV-CU y TPD32-EV-FC. Modelo de construcción E, modelos TPD32-EV-690/... y TPD32-EV_12P/12S no incluidos).
 EMC: De acuerdo con la directiva CE - EN 61800-3, sobre la compatibilidad electromagnética con el empleo de filtros opcionales.

(*) Excluyendo la serie TPD32-EV-FC-...



Applications

- Parameter configuration of Gefran devices (Instruments, Drives, Sensors)
- Tuning of control parameters with on-line tests and trends
- Management of parameter archive for multiple configuration

Features

- Guided product selection
- Simplified settings
- Multiple languages
- Parameter printout
- Creation and storing of recipes
- Network autoscan

GF_eXpress is the software used to configure the parameters of the automation components, drives and sensors in the Gefran catalogue.

The procedures for selecting and configuring parameters are easy and intuitive, thanks to the graphic interface and devices are grouped according to product type and functions.

Product searches are performed by means of a context search and a visual selection from among actual images of the products.

This makes it possible to have a single library of devices for all Gefran products.

All details for configuration of each single device are set out in XML format to facilitate expansion of the catalogue and parameters.

The selected product can be configured as follows:

- using a sub-set of predefined parameters,
- using a guided graphic interface with context menus.

“GF_eXpress” PC Configuration Tool



The creation of custom parameter menus with a limited sub-set of data is envisaged, to enable better and more effective device configuration.

GF_eXpress is based on HTML technology. The graphic layout and content are intuitive and easy to use.

The interface and descriptions of the configuration parameters are available in multi-language format.

The use and support of UNICODE format, for multi-language management, enables the inclusion of languages that use special characters (Chinese, Korean, Russian, etc.).

GF_eXpress also offers the following functions:

Autoscan

Device connection parameters can be configured manually or using the Autoscan function.

The Autoscan function automatically searches for the device connected to the development PC, sending serial commands to identify the type and parameters of communication.

Monitor Window

When the device is connected, the configuration pages display the value of the single parameter in real-time.

Besides displaying the value the Monitor Window also enables parameters to be modified in real-time.

Recipes

Saving and archiving a list of parameters. This function is used to manage same configurations on different devices or the transfer of configurations between different users.

Oscilloscope

Simultaneous monitoring of up to 8 curves. The reference value for the curve being displayed can be selected from among all the variables that are available for the selected device.

Print

Prints the variables that are displayed or selected. The Print function also includes the preview.

Technical data

Windows © 2000, XP, Vista, 7.

Minimum PC requirements:

- Pentium class CPU
- 512 MB of RAM
- Free space of > 200MB
- Graphic card min. VGA (1024x768)
- 1 RS232 or USB serial port
- 1 Ethernet port (for other Gefran devices, e.g. Geflex).

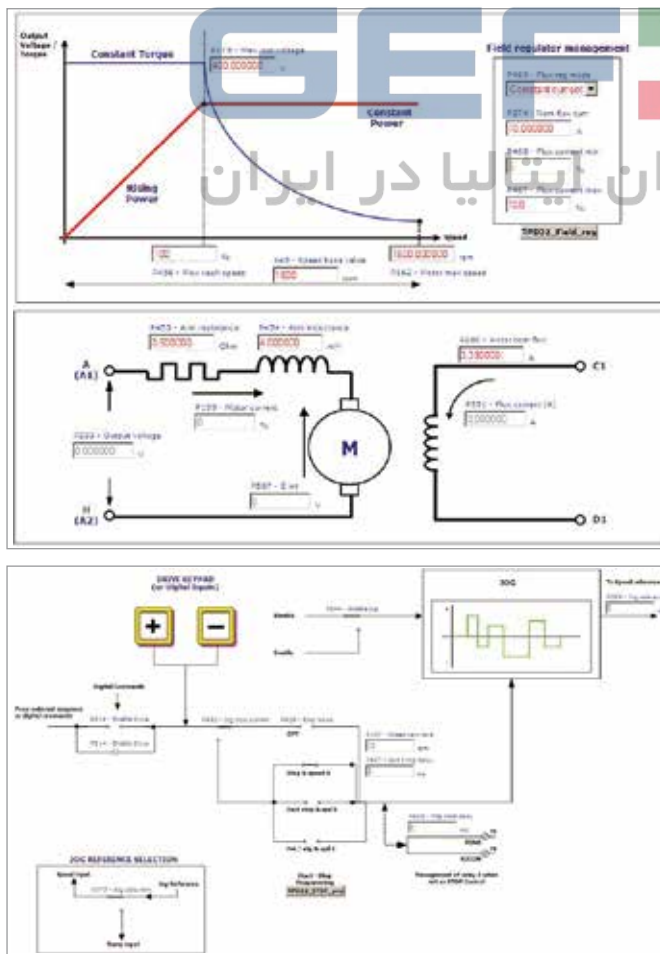

Applicazioni

- Parametrizzazione dispositivi Gefran (Strumentazione, Drive, Sensori)
- Sintonizzazione parametri di regolazione con test on-line e Trend
- Gestione archivio parametri per configurazione multiple

Caratteristiche

- Selezione guidata dei prodotti
- Impostazione semplificata
- Multilingua
- Stampa parametri
- Creazione e salvataggio di ricette
- Autoscan della rete

GF_eXpress è il software di configurazione / parametrizzazione di componenti, automazione, drive e sensori del catalogo Gefran.

La selezione e la parametrizzazione dello strumento è facile e intuitiva grazie ad una interfaccia grafica, con una divisione di dispositivi per tipologie di prodotti e funzionalità.

La scelta del prodotto da parametrizzare avviene attraverso un menu contestuale e con selezione visiva attraverso immagini reali del prodotto.

Questa gestione permette di avere una unica libreria di dispositivi per tutti i prodotti Gefran.

L'adozione del formato XML per la descrizione delle informazioni di configurazione di tutti i singoli dispositivi facilita l'espansione del catalogo e dei suoi parametri.

"GF_eXpress", Tool di Configurazione per PC



La configurazione del prodotto selezionato può avvenire:

- sfruttando un "sub-set" di parametri predefiniti,
- utilizzando un'interfaccia grafica guidata con menu contestuali.

Per migliorare e rendere più efficace la configurazione dei dispositivi, è prevista la creazione di menu di parametrizzazione custom con un limitato sub-set di dati. GF_eXpress si basa sulla tecnologia HTML e, dal punto di vista grafico e dei contenuti, è intuitivo e di facile utilizzo.

È previsto il supporto multilingue per quanto riguarda l'interfaccia e la descrizione dei parametri di configurazione.

L'utilizzo e il supporto del formato UNICODE, nella gestione multilingua, permette di integrare anche lingue che prevedono l'utilizzo di particolari caratteri (cinese, coreano, russo, etc.).

In GF_eXpress sono anche disponibili le seguenti funzioni:

Autoscan

La configurazione dei parametri di collegamento al dispositivo, per la connessione, può avvenire manualmente oppure con funzione Autoscan.

La funzione di Autoscan ricerca automaticamente il dispositivo collegato al PC di sviluppo, inviando comandi seriali che ne identificano il tipo e parametri di comunicazione.

Monitor Window

Attivando la connessione con il dispositivo, è possibile all'interno delle pagine di configurazione, visualizzare in tempo reale il valore del singolo parametro.

La funzione Monitor Window oltre che alla visualizzazione del valore permette la modifica dei parametri in tempo reale.

Ricette

Salvataggio e archiviazione di una lista di parametri. Questa funzione permette la gestione di configurazioni uguali su diversi dispositivi o il passaggio di configurazioni tra diversi utenti.

Oscilloscopio

Monitoraggio fino ad 8 curve in contemporanea. La selezione del valore di riferimento alla curva visualizzata può avvenire tra tutte le variabili disponibili nel dispositivo selezionato.

Stampa

Stampa delle variabili visualizzate oppure selezionate. La funzione di Stampa include anche il preview.

Dati Tecnici

Sistemi operativi: Windows © 2000, XP, Vista, 7.

Configurazione minima PC:

- CPU classe Pentium
- RAM 512 MB
- Spazio libero su disco > 200 MB
- Scheda grafica min. VGA (1024x768)
- N. 1 Porta seriale RS232 o USB
- N. 1 Porta Ethernet (per altri dispositivi Gefran, es. Geflex).

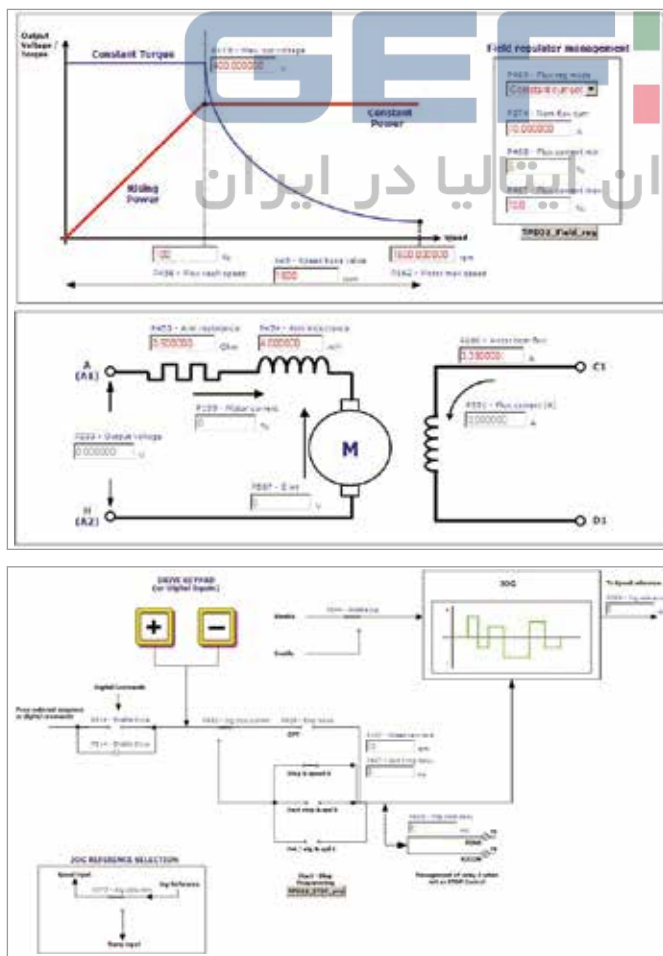



Applications

- Paramétrage des dispositifs Gefran (Instruments, Drives, Capteurs)
- Réglage des paramètres de régulation avec test en-ligne et Courbe
- Gestion de l'archive des paramètres pour configurations multiples

Caractéristiques

- Sélection guidée des produits
- Paramétrage simplifié
- Multilingages
- Impression des paramètres
- Création et enregistrement des recettes
- Autocan du réseau

GF_eXpress est le logiciel de configuration / paramétrage des composants, de l'automatisation, des drives et capteurs du catalogue Gefran.

La sélection et le paramétrage du variateur est facile et intuitive grâce à une interface graphique, avec une séparation des dispositifs par type de produits et fonctionnement.

Le choix du produit à paramétrer s'effectue par un menu contextuel et avec une sélection visuelle à l'aide d'images réelles du produit.

Cette gestion permet d'avoir une seule bibliothèque de dispositifs pour tous les produits Gefran.

L'adoption du format XML pour la description des informations de configuration de tous les dispositifs facilite l'expansion du catalogue et des ses paramètres.

"GF_eXpress" Outil de Configuration pour PC



La configuration du produit sélectionné peut se faire:

- en utilisant un "sub-set" de paramètres prédéfinis,
- en utilisant une interface graphique guidée avec des menus contextuels.

Pour améliorer et rendre plus efficace la configuration des dispositifs, il est prévu la création de menus de paramétrage custom avec une limite sub-set de données.

GF_eXpress se base sur la technologie HTML et, du point de vue graphique et des contenus, il est intuitif et facile à utiliser.

Il est prévu avec un support multi-langues pour ce qui concerne l'interface et la description des paramètres de configuration.

L'utilisation et le support du format UNICODE, dans la gestion multi-langues, permet également d'incorporer les langues qui prévoient l'utilisation de caractères particuliers (chinois, coréen, russe, etc.).

Dans GF_eXpress on trouve également les fonctions suivantes:

Autoscan

La configuration des paramètres de raccordement au dispositif, pour la connexion, peut se faire manuellement ou par la fonction Autoscan.

La fonction Autoscan recherche automatiquement le dispositif relié au PC de développement, en lui envoyant des commandes port série qui en identifient le type et les paramètres de communication.

Moniteur Window

En activant la connexion avec le dispositif, il est possible, à l'intérieur des pages de configuration, de visualiser en temps réel la valeur du paramètre.

La fonction Moniteur Window permet également de visualiser la valeur et d'en permettre la modification en temps réel.

Recettes

Enregistrer et archiver une liste des paramètres. Cette fonction permet la gestion de configurations identiques sur différents dispositifs ou le passage de configurations à différents utilisateurs.

Oscilloscope

Monitoring jusqu'à 8 courbes en même temps. La sélection de la valeur de référence à la courbe visualisée peut se faire pour toutes les variables disponibles dans le dispositif sélectionné.

Impression

Impression des variables visualisées ou sélectionnées. La fonction d'impression comprend également la fonction pour pré-visualiser.

Caractéristiques techniques

Systèmes d'exploitation: Windows® 2000, XP, Vista, 7.

Configuration minimum du PC:

- CPU classe Pentium
- RAM 512 MO
- Spazio libero su disco > 200 MB
- Carte graphique mini. VGA (1024x768)
- N. 1 Port série RS232 ou USB
- N. 1 Port Ethernet (pour d'autres dispositifs Gefran, ex. Geflex).

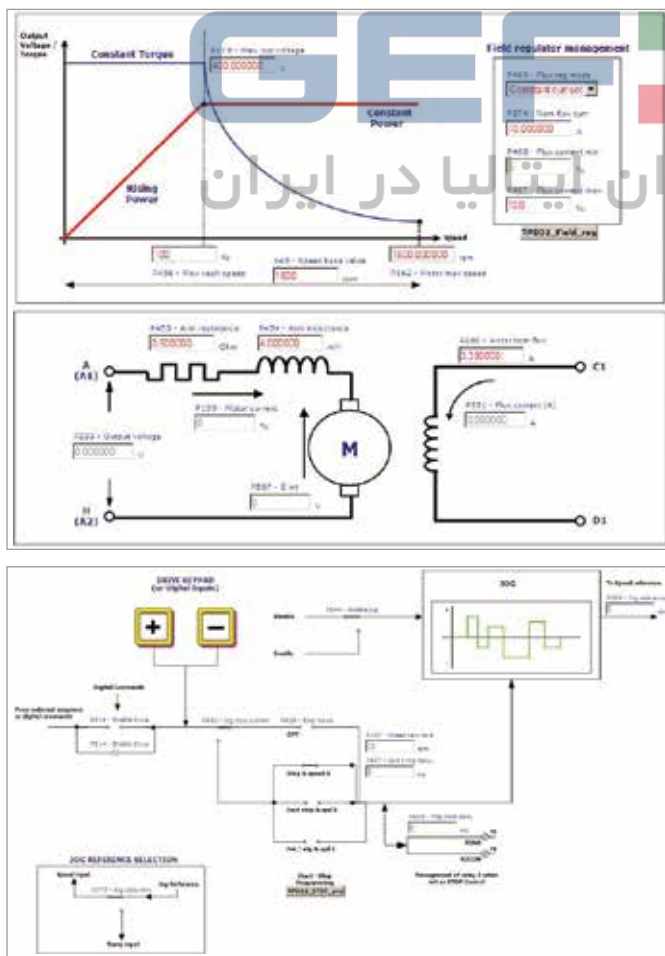



Anwendungen

- Parametrierung der Gefran-Geräte (Instrumente, Antriebe, Sensoren)
- Abstimmung der Regelparameter mit Online-Tests und Trends
- Verwaltung Parameterarchiv für Mehrfachkonfigurationen

Merkmale

- Geführte Produktauswahl
- Vereinfachte Einstellung
- Mehrsprachig
- Parameterausdruck
- Rezepterstellung und -speicherung
- Netzwerk-Selbstscanning

GF_eXpress ist die Konfigurations-/Parametrierungssoftware für Instrumente, Automation, Antriebe und Sensoren aus dem Gefran-Katalog.

Die Auswahl und Parametrierung des Gerätes ist dank einer graphischen Schnittstelle einfach und logisch, die Geräte sind nach Produkttypen und Funktionen unterteilt.

Die Wahl des zu parametrierenden Produkts erfolgt über ein Kontextmenü und mittels visueller Auswahl über echte Produktbilder.

Diese Art der Verwaltung ermöglicht es, mit einer einzigen Gerätebibliothek über alle Gefran-Produkte zu verfügen.

Die Verwendung des XML-Formats für die Beschreibung der Konfigurationsinformationen zu allen einzelnen Geräten vereinfacht die Erweiterung des Katalogs und seiner Parameter.

“GF_eXpress” PC-Konfigurationstool



Die Konfiguration des gewählten Produkts kann folgendermaßen erfolgen:

- Nutzung eines “Subsets” vordefinierter Parameter,
- Verwendung einer geführten graphischen Schnittstelle mit Kontextmenüs.

Um die Konfiguration der Geräte zu vereinfachen und wirksamer zu gestalten, ist die Erzeugung von Kunden-Parametrierungsmenüs mit einem beschränkten Daten-Subset vorgesehen.

GF_eXpress basiert auf HTML-Technologie und ist in graphischer und inhaltlicher Hinsicht logisch und einfach anzuwenden.

Die Schnittstelle und die Beschreibung der Konfigurationsparameter sind mehrsprachig erhältlich.

Die Verwendung und Unterstützung des UNICODE-Formats bei der mehrsprachigen Verwaltung ermöglicht es, auch Sprachen zu integrieren, die Sonderzeichen verwenden (chinesisch, koreanisch, russisch, usw.).

GF_eXpress bietet auch folgende Funktionen:

Autoscan

Die Konfiguration der Verbindungs-Parameter beim Anschluss eines Gerätes kann manuell oder über die Autoscanning-Funktion erfolgen.

Die Autoscanning-Funktion sucht automatisch das an den PC angeschlossene Gerät, indem sie serielle Befehle sendet, mit denen Geräte-Typ und Kommunikationsparameter identifiziert werden.

Monitorfenster

Durch die Aktivierung der Verbindung mit dem Gerät kann der Wert des einzelnen Parameters auf den Konfigurationsseiten in Echtzeit angezeigt werden.

Die Funktion Monitorfenster ermöglicht nicht nur die Anzeige des Werts sondern auch die Parameteränderung in Echtzeit.

Rezepte

Speicherung und Ablage einer Parameterliste. Diese Funktion ermöglicht die Verwaltung gleicher Konfigurationen auf verschiedenen Geräten oder die Konfigurationsweitergabe zwischen verschiedenen Benutzern.

Oszilloskop

Überwachung von bis zu 8 Kurven gleichzeitig. Die Auswahl des Sollwerts für die angezeigte Kurve kann unter allen verfügbaren Variablen des gewählten Gerätes erfolgen.

Ausdruck

Ausdruck der angezeigten oder gewählten Variablen. Die Ausdruckfunktion schließt auch die Vorschau mit ein.

Technische Daten

Betriebssysteme: Windows © 2000, XP, Vista, 7.

PC-Mindestkonfiguration:

- CPU Klasse Pentium
- RAM 512 MB
- Freier Speicherplatz auf der Festplatte > 200 MB
- Graphikkarte mind. VGA (1024x768)
- 1 Serieller Anschluss RS232 oder USB
- 1 Ethernet-Anschluss (für andere Gefran-Geräte, z.B. Geflex).

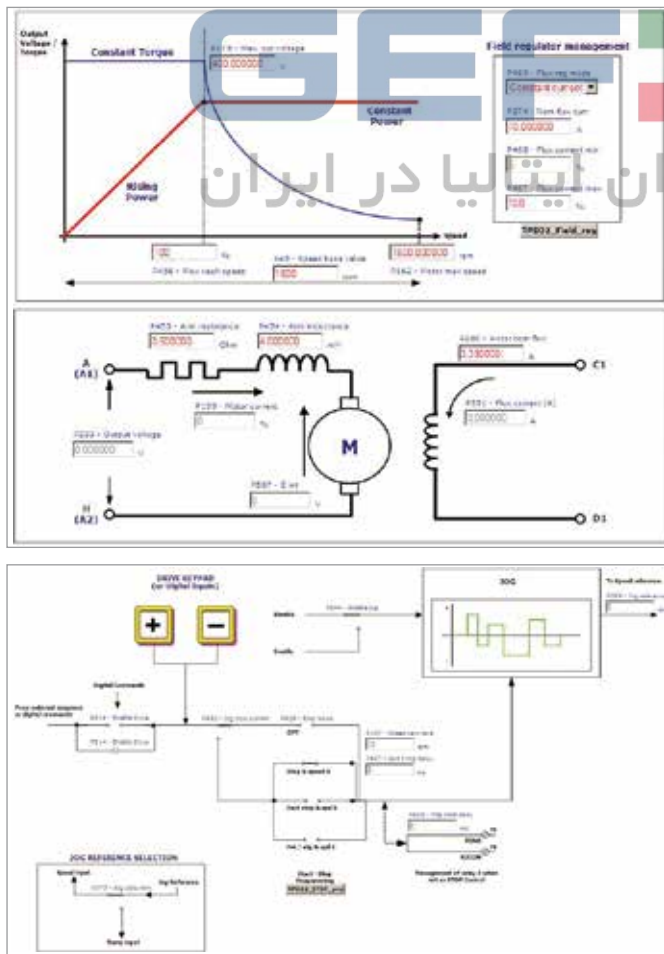



Aplicaciones

- Parametrización de dispositivos Gefran (Instrumentación, Convertidor, Sensores)
- Sintonización parámetros de regulación con test on-line y Trend
- Gestión archivo parámetros para configuración múltiple

Características

- Selección guiada de los productos
- Ajuste simplificado
- Multilingüe
- Impresión parámetros
- Creación y almacenamiento de fórmulas
- Autoexploración de la red

GF_eXpress es el software de configuración/parametrización de componentes, automatización, convertidores y sensores del catálogo Gefran.

La selección y la parametrización del instrumento es fácil e intuitivo gracias a un interface gráfico, con una clasificación de los dispositivos por tipologías de productos y funcionalidad.

La selección del producto de parametrización se lleva a cabo mediante un menú contextual y con la selección visual mediante imágenes reales del producto.

Esta gestión permite tener una biblioteca única de dispositivos para todos los productos Gefran.

La adopción del formato XML para la descripción de las informaciones de configuración de todos los dispositivos individuales facilita la ampliación del catálogo y de sus parámetros.

“GF_eXpress” Herramienta de configuración para PC



La configuración del producto seleccionado se puede efectuar:

- aprovechando un “sub-grupo” de parámetros predefinidos,
- utilizando un interface gráfico asistido por menús contextuales.

Para mejorar y hacer más eficaz la configuración de los dispositivos, está prevista la creación de menús de parametrización personalizados con un subgrupo de datos limitado.

GF_eXpress está basado en la tecnología HTML y, desde el punto de vista gráfico y de contenido, resulta intuitivo y fácil de utilizar.

Está previsto el soporte multilingüe por lo que se refiere al interface y a la descripción de los parámetros de configuración.

El uso y el soporte del formato UNICODE, en la gestión multilingüe, permite integrar también idiomas que incluyan el uso de caracteres particulares (chino, coreano, ruso, etc.).

En el GF_eXpress también están disponibles las siguientes funciones:

Autoexploración

La configuración de los parámetros de conexión al dispositivo, para la activación, se puede realizar manualmente o con la función de Autoexploración.

La función de Autoexploración busca automáticamente el dispositivo conectado al PC operativo, enviando comandos en serie que identifican el tipo y los parámetros de comunicación.

Ventana Monitor

Activando la conexión con el dispositivo, es posible visualizar, en el interior de las páginas de configuración, el valor de cada parámetro a tiempo real.

La función de la ventana Monitor, además de la visualización del valor permite la modificación de los parámetros a tiempo real.

Fórmulas

Almacenamiento y archivado de una lista de parámetros. Esta función permite la gestión de configuraciones iguales en varios dispositivos o la transferencia de configuraciones entre varios usuarios.

Osciloscopio

Monitorización de hasta 8 curvas simultáneamente. La selección del valor de referencia en la curva visualizada se puede efectuar entre todas las variables disponibles en el dispositivo seleccionado.

Impresión

Impresión de las variables visualizadas o seleccionadas. La función de impresión incluye también la vista previa.

Datos técnicos

Sistemas operativos: Windows © 2000, XP, Vista, 7.

Configuración mínima PC:

- CPU clase Pentium
- RAM 512 MB
- Espacio libre en disco > 200 MB
- Tarjeta gráfica mín. VGA (1024x768)
- 1 puerto serie RS232 o USB
- 1 puerto Ethernet (para otros dispositivos Gefran, por ej. Geflex).

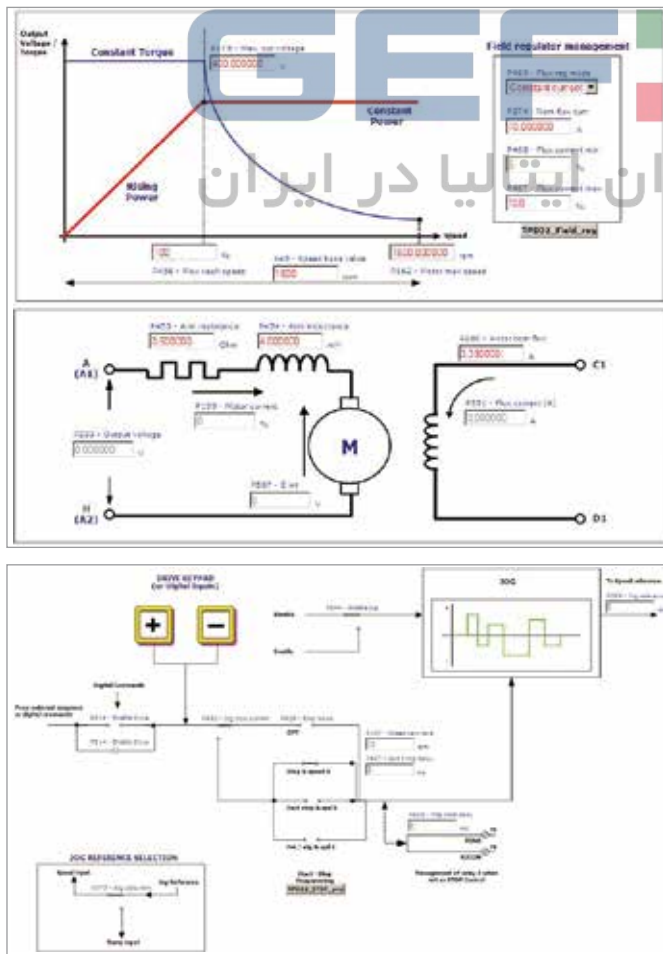

TPD32 EV-.../...-...-... Compact Case

Input and Output data
Dati in Uscita e in Ingresso
Caractéristiques de Sortie et
d'Entrée

Ausgangsdaten und Eingangsdaten
Datos de Salida y Entrada

TPD32 EV European Drive Rating	TPD32 EV-...-NA American Drive Rating	2 quadrant : 2B	4 quadrant : 4B	Frame	ULN AC Input Voltage			AC Input Frequency	IDN Rated Output Current European	IDN Rated Output Current American (1)	IOLVD Output Current Overload	UDN DC Output Voltage						AC Input Voltage for Field Circuit	UFN DC Field Voltage (0.85 * ULN)	IFN Field Current @ 40°C	AC Input Voltage of regulation part
					TPD32 EV-500	TPD32 EV-575	TPD32 EV-690					TPD32 EV-500		TPD32 EV-575		TPD32 EV-690					
					230 ... 500Vac ± 10%, 3ph	230 ... 575Vac ± 10%, 3ph	230 ... 690Vac ± 10%, 3ph					2B	4B	2B	4B	2B	4B				
[VAC]	[VAC]	[VAC]	[Hz]	[A]	[A]	[A]	[VAC]	[VDC]	[A]	[VAC]											
20	17	.	.	A1	.			20	17										10		
40	35	.	.	A1	.			40	35										10		
70	56	.	.	A2	.			70	56										10		
110	88	.	.	A3	.			110	88										14		
140	112	.	.	A3	.			140	112										14		
185	148	.	.	A3	.			185	148										14		
280	224	.	.	B1	.	.		280	224										20		
350	280	.	.	B1	.	.		350	280										20		
420	336	.	.	B1	.	.		420	336										20		
500	400	.	.	B1	.	.		500	400										20		
560	360	.	.	C	.	.		560	360										25		
650	450	.	.	B2	.	.		650	450										20		
700	490	.	.	C	.	.		700	490										25		
770	560	.	.	C	.	.		770	560										25		
900	650	.	.	C	.	.		900	650										25		
1000	750	.	.	C	.	.		1000	750										25		
1050	750	.	.	C	.	.		1050	750										25		
1000	800	.	.	C	.	.		1000	800										25		
1050	850	.	.	C	.	.		1050	850										25		
1300	920	.	.	D	.	.		1300	920										40		
1300	980	.	.	D	.	.		1300	980										40		
1300	980	.	.	D	.	.		1300	980										40		
1400	1000	.	.	D	.	.		1400	1000										40		
1600	1200	.	.	D	.	.		1600	1200										40		
1900	1450	.	.	D	.	.		1900	1450										40		
2000	1500	.	.	D	.	.		2000	1500										40		
2100	1650	.	.	D	.	.		2100	1650										70		
2300	1800	.	.	D	.	.		2300	1800										70		
2400	1850	.	.	D	.	.		2400	1850										70		

(1): 150% Overload factory settings.
 Impostazione di fabbrica sovraccarico 150%.
 Configuration en usine surcharge 150%.
 150% überlast Werkseinstellung.
 Ajuste de fábrica sobrecarga 150%.

TPD32 EV-.../...-...-... External Bridge

Input and Output data
Dati in Uscita e in Ingresso
Caractéristiques de Sortie et
d'Entrée

Ausgangs und Eingangsdaten
Datos de Salida y Entrada

TPD32 EV European Drive Rating	TPD32 EV-...-NA American Drive Rating	2 quadrant : 2B	4 quadrant : 4B	Frame	ULN AC Input Voltage		AC Input Frequency	IDN Rated Output Current European	IDN Rated Output Current American (1)	IOVLD Output Current Overload	UDN DC Output Voltage				AC Input Voltage for Field Circuit	UFN DC Field Voltage (0.85 * ULN)	IFN Field Current @ 40 °C	AC Input Voltage of regulation part
					TPD32 EV-500	TPD32 EV-690					TPD32 EV-500		TPD32 EV-690					
					[VAC]	[VAC]					2B	4B	2B	4B				
1200	1000	•		E	230 VAC ... 500 VAC ±10%, 3-phase		50/60 Hz±5%	1200	1000	Programmable IDN up to 200%	600 Vdc	520 Vdc						40
1500	1300	•	•	E				1500	1300									40
1700	1350		•	E				1700	1350									40
1800	1400	•		E				1800	1400									40
2000	1500	•	•	E				2000	1500									40
2400	1800	•	•	E				2400	1800									70
2700	2000	•	•	E				2700	2000									70
2900	2200	•		E				2900	2200									70
3300	2350	•	•	E				3300	2350									70
1010	900	•	•	E				230 VAC ... 690 VAC ±10%, 3-phase										1010
1400	1150	•	•	E	1400	1150	40											
1700	1350	•	•	E	1700	1350	40											
2000	1500	•	•	E	2000	1500	40											
2400	1800	•	•	E	2400	1800	70											
2700	2000	•	•	E	2700	2000	70											
3300	2350	•	•	E	3300	2350	70											

(1): 150% Overload factory settings.
 Impostazione di fabbrica sovraccarico 150%.
 Configuration en usine surcharge 150%.
 150% überlast Werkseinstellung.
 Ajuste de fábrica sobrecarga 150%.

TPD32 EV-FC-...

Input and Output data
Dati in Uscita e in Ingresso

Caractéristiques de Sortie et d'Entrée
Ausgangsdaten und Eingangsdaten
Datos de Salida y Entrada

TPD32 EV-FC Drive Rating	2 quadrant : 2B (TPD32-EV-FC-500/... only)	4 quadrant : 4B	Frame	ULN AC Input Voltage	AC Input Frequency	IDN Rated Output Current European	UDN DC Output Voltage		AC Input Voltage of regulation part
				[VAC]	[Hz]	[A]	2B	4B	[VAC]
20	•	•	A1	TPD32-EV-FC-200/...: 60...200 VAC ±10%, 3 ph	50/60 Hz ±5%	20	600 Vdc	TPD32-EV-FC-200/...: 210 Vdc	115 VAC ±15% or 230 VAC ±15%, single-phase, 50/60Hz ±5%
40	•	•	A1			40			
70	•	•	A2			70			
110	•	•	A3			110			
140	•	•	A3			140			
185	•	•	A3			185			
280	•	•	B1			280			
350	•	•	B1			350			
420	•	•	B1			420			
500	•	•	B1			500			
650	•	•	B2	650	TPD32-EV-FC-500/...: 230 VAC ... 500 VAC ±10%, 3 ph	TPD32-EV-FC-500/...: 520 Vdc			

GEFIRAN

نماینده رسمی جفران ایتالیا در ایران

Converter Selection

TPD32-EV-CU-...

Input and Output data
Dati in Uscita e in Ingresso

Caractéristiques de Sortie et d'Entrée
Ausgangsdaten und Eingangsdaten
Datos de Salida y Entrada

TPD32-EV-CU models	2 quadrant / 4 quadrant	Frame	ULN AC Input Voltage	AC Input Frequency	IDN Rated Output Current (selectable)	Iovld Output Current Overload	UDN DC Output Voltage	AC Input Voltage for Field Circuit	UDN DC Field Voltage (0.85 * ULN)	IFN Field Current @ 40°C	AC Input Voltage of regulation part
			[VAC]	[Hz]	[A]	[A]	[Vdc]	[VAC]	[Vdc]	[A]	[VAC]
TPD32-EV-CU-230/500-THY1-40	•	A1	230 ... 500 Vac ±10%, 3-phase	50/60 Hz ±5%	4 ... 20000 A	Programmable IDN up to 200%	520/600 Vdc	230 Vac ±15% or 400 Vac ±15% or 460 Vac ±10%, single-phase, 50/60Hz ±5%	Fixed or adjustable: 200 Vdc (for 230 Vac) or 310 Vdc (for 400 Vac) or 360 Vdc (for 460 Vac)	40	115 VAC ±15% or 230 VAC ±15%, single-phase, 50/60Hz ±5%
TPD32-EV-CU-230/500-THY2-40	•	A1								40	
TPD32-EV-CU-230/500-THY1-70	•	A1								70	
TPD32-EV-CU-230/500-THY2-70	•	A1	70								
TPD32-EV-CU-575/690-THY1-40	•	A1	575 ... 690 Vac ±10%, 3-phase	720/810 Vdc	230 Vac ±15% or 400 Vac ±15% or 460 Vac ±10%, single-phase, 50/60Hz ±5%	Fixed or adjustable: 200 Vdc (for 230 Vac) or 310 Vdc (for 400 Vac) or 360 Vdc (for 460 Vac)	40				
TPD32-EV-CU-575/690-THY2-40	•	A1					40				
TPD32-EV-CU-575/690-THY1-70	•	A1					70				
TPD32-EV-CU-575/690-THY2-70	•	A1					70				

TPD32 EV-.../...-...-12P

Input and Output data
Dati in Uscita e in Ingresso
Caractéristiques de Sortie et
d'Entrée

Ausgangs und Eingangsdaten
Datos de Salida y Entrada

TPD32 EV-...-12P European Drive Rating	2 quadrant : 2B	4 quadrant : 4B	Frame	ULN AC Input Voltage	AC Input Frequency	IDN Total Rated Output Current	IovLD Output Current Overload	UoN DC Output Voltage		AC Input Voltage for Field Circuit	UFN DC Field Voltage (0.85 * ULN)	IFN Field Current @ 40°C	AC Input Voltage of regulation part
				[VAC]				[Hz]	[A]				
1010	•	•	E	TPD32-EV-690-... 230 VAC ... 690 VAC ± 10%, 3-phase TPD32-EV-1000-... 400 VAC ... 1000 VAC ± 10%, 3-phase	50/60 Hz ± 5%	2000	Programmable IDN up to 200%	TPD32-EV-690-...: 810 VDC TPD32-EV-1000-...: 1200 VDC	TPD32-EV-690-...: 720 VDC TPD32-EV-1000-...: 1000 VDC	230 VAC ± 15% or 400 VAC ± 15% or 460 VAC ± 10%, single-phase, 50/60Hz ± 5%	Fixed or adjustable: 200 VDC (for 230 VAC) or 310 VDC (for 400 VAC) or 360 VDC (for 460 VAC)	40	115 VAC ± 15% or 230 VAC ± 15%, single-phase , 50/60Hz ± 5%
1400	•	•	E			2800						40	
1700	•	•	E			3400						40	
2000	•	•	E			4000						40	
2400	•	•	E			4800						70	
2700	•	•	E			5400						70	
3300	•	•	E			6600						70	

TPD32 EV-.../...-...-12S

Input and Output data
Dati in Uscita e in Ingresso
Caractéristiques de Sortie et
d'Entrée

Ausgangs und Eingangsdaten
Datos de Salida y Entrada

TPD32 EV-...-12S European Drive Rating	2 quadrant : 2B	4 quadrant : 4B	Frame	ULN AC Input Voltage	AC Input Frequency	IDN Total Rated Output Current	IovLD Output Current Overload	UoN DC Output Voltage		AC Input Voltage for Field Circuit	UFN DC field Voltage (0.85 * ULN)	IFN Field Current @ 40°C	AC Input Voltage of regulation part
				[VAC]				[Hz]	[A]				
1010	•	•	E	TPD32-EV-350-... 230 VAC ... 350 VAC ± 10%, 3-phase TPD32-EV-500-... 350 VAC ... 500 VAC ± 10%, 3-phase	50/60 Hz ± 5%	1000	Programmable IDN up to 200%	TPD32-EV-350-...: 410 VDC TPD32-EV-500-...: 500 VDC	TPD32-EV-350-...: 360 VDC TPD32-EV-500-...: 500 VDC	230 VAC ± 15% or 400 VAC ± 15% or 460 VAC ± 10%, single-phase, 50/60Hz ± 5%	Fixed or adjustable: 200 VDC (for 230 VAC) or 310 VDC (for 400 VAC) or 360 VDC (for 460 VAC)	40	115 VAC ± 15% or 230 VAC ± 15%, single-phase , 50/60Hz ± 5%
1400	•	•	E			1400						40	
1700	•	•	E			1700						40	
2000	•	•	E			2000						40	
2400	•	•	E			2400						70	
2700	•	•	E			2700						70	
3300	•	•	E			3300						70	



The 12 pulses external bridge DC drives are composed by two bridges connected in parallel or series.



I convertitori DC a 12 impulsi sono composti da 2 ponti esterni collegati in parallelo o in serie.



Les convertisseurs CC à 12 impulsions sont constitués de 2 ponts externes reliés en parallèle ou en série.



Die DC-Stromrichter mit 12 Impulsen bestehen aus 2 externen Brücken, die parallel oder in Reihe geschaltet sind.



Los convertidores CC de 12 impulsos constan de 2 puentes externos conectados en paralelo o en serie.

TPD32 EV-...

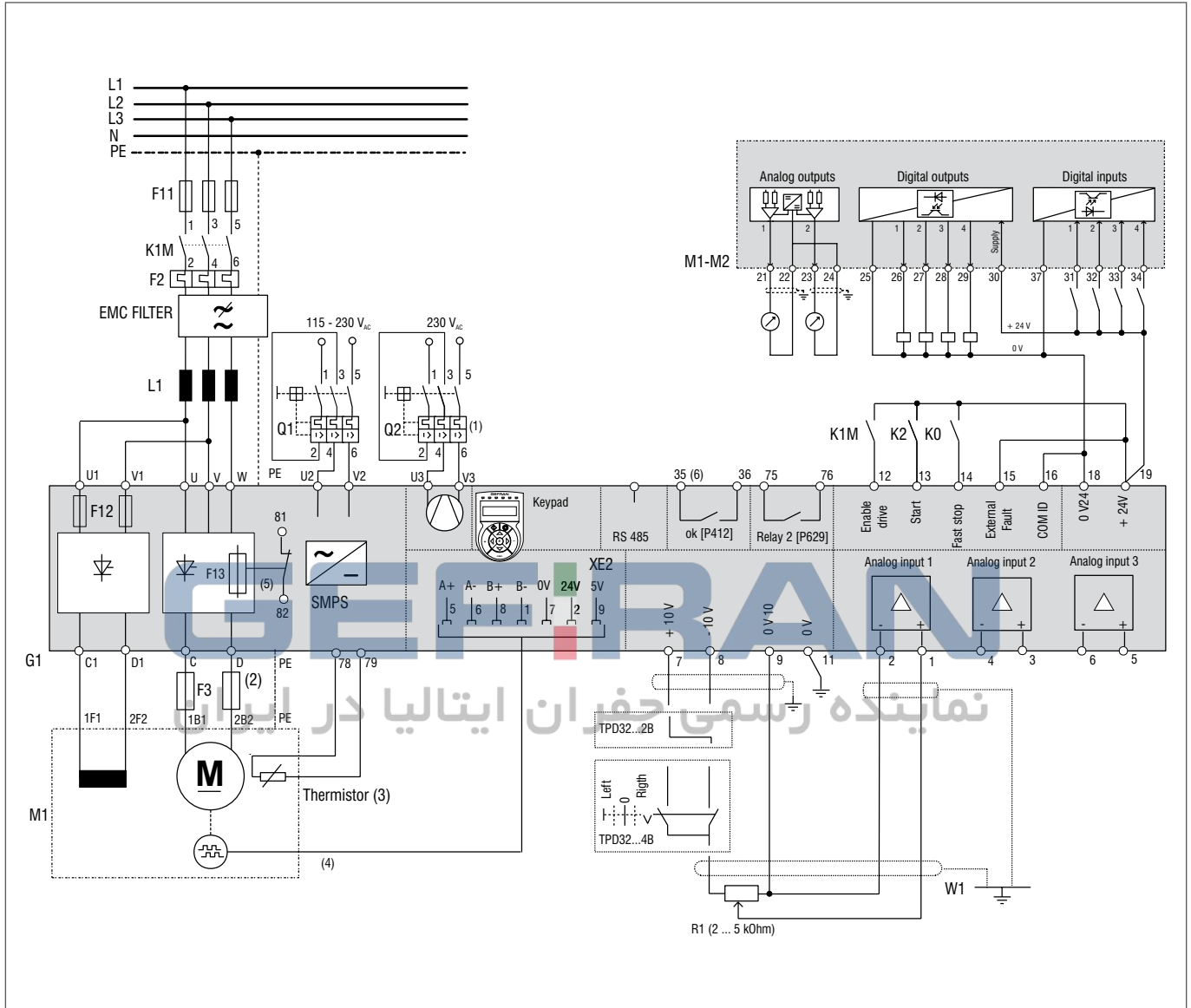

Connection Scheme



(1) Fan with external supply only for TPD32 EV-...-C and TPD32 EV-...-D. (2) Fuses only for TPD32 EV-...4B-C and TPD32 EV-...4B-D. (3) 1kOhm resistor connected when the thermistor is not present. (4) The indicated connections are relative for a digital Encoder. (5) Only for TPD32 EV-...4B-C and TPD32 EV-...4B-D. (6) On the "FIR ..." Power/Control card.



(1) Ventilatori con alimentazione esterna solo per TPD32 EV-...-C e TPD32 EV-...-D. (2) Fusibili solo per TPD32 EV-...4B-C e TPD32 EV-...4B-D. (3) Resistore da 1kohm collegato quando non è presente il termistore. (4) Il collegamento qui indicato vale solo per encoder digitali. (5) Solo per TPD32 EV-...4B-C e TPD32 EV-...4B-D. (6) Sulla scheda Potenza / Controllo "FIR ...".



(1) Ventilateurs avec alimentation extérieure seulement pour TPD32 EV-...-C et TPD32 EV-...-D. (2) Fusibles seulement pour TPD32 EV-...4B-C et TPD32 EV-...4B-D. (3) Résistor de 1kohm connecté lorsque la sonde thermique n'est pas installée. (4) Le raccordement indiqué ici n'est valable que pour les codeurs digitaux. (5) Seulement pour TPD32 EV-...4B-C et TPD32 EV-...4B-D. (6) Sur la carte Puissance / Contrôle « FIR ... ».



(1) Lüfter mit externer Versorgung nur TPD32 EV-...-C und TPD32 EV-...-D. (2) Sicherungen nur für TPD32 EV-...4B-C und TPD32 EV-...4B-D. (3) Ohne Thermistor 1 kohm Widerstand verwenden. (4) Bei Verwendung eines Digitalencoders. (5) Nur für TPD32 EV-...4B-C und TPD32 EV-...4B-D. Auf der Leistungskarte / Steuerung "FIR ...".



(1) Ventiladores con alimentación externa sólo para TPD32 EV-...-C e TPD32 EV-...-D. (2) Fusibles sólo para TPD32 EV-...4B-C e TPD32 EV-...4B-D. (3) Resistencias de 1 Kohm conectadas cuando no se ha instalado un termistor. (4) La conexión indicada sólo es válida para encoder digitales. (5) Sólo para TPD32 EV-...4B-C e TPD32 EV-...4B-D. (6) En la placa Potencia/Control "FIR ...".

TPD32 EV-FC-...

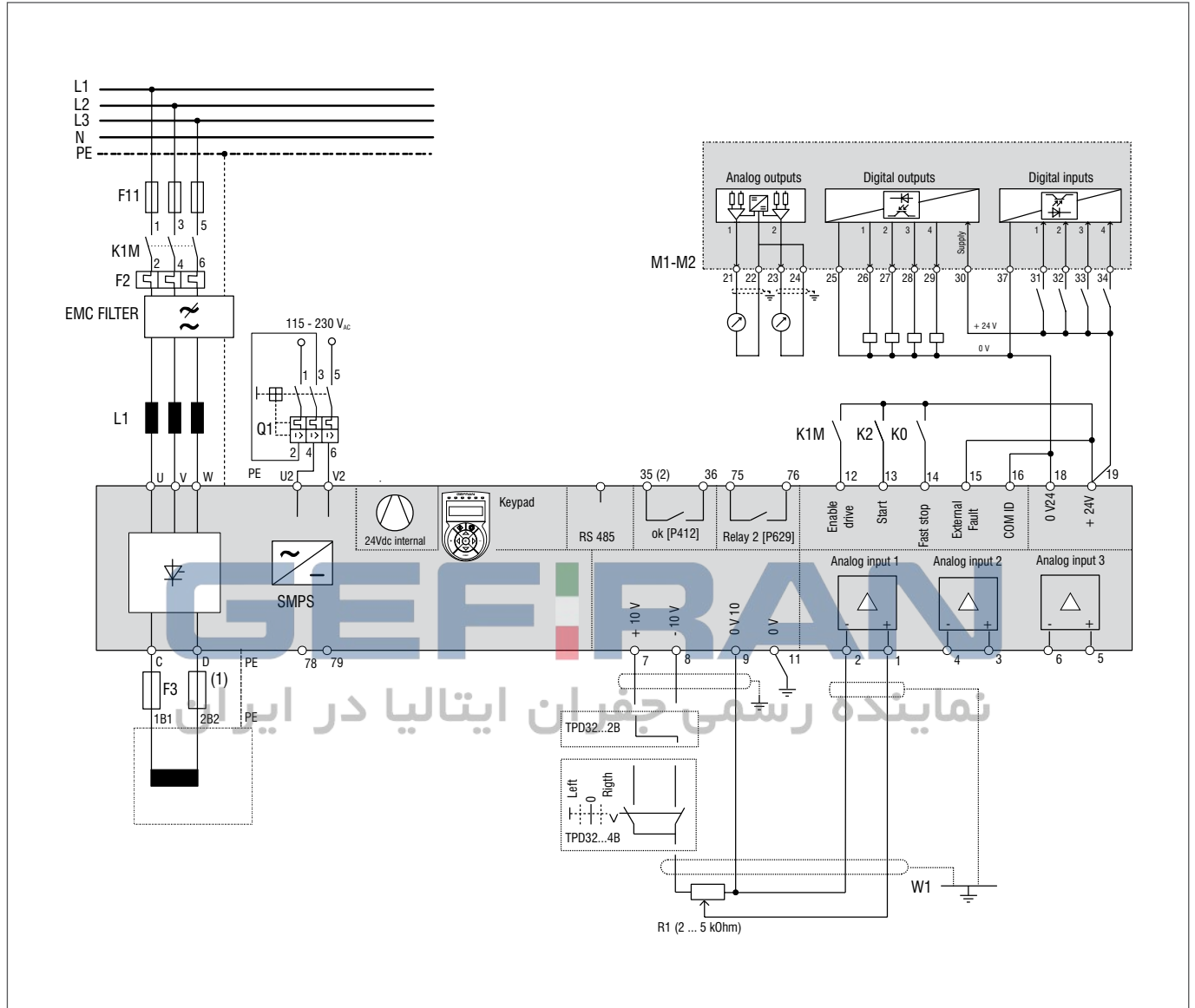

(1) Fuses only for TPD32 EV-FC-...4B-C. (2) On the "FIR ..." Power/Control card.

(1) Fusibili solo per TPD32 EV-FC-...4B-C. (2) Sulla scheda Potenza / Controllo "FIR ...".

(1) Fusibles seulement pour TPD32 EV-FC-...4B-C. (2) Sur la carte Puissance / Contrôle « FIR ... ».

(1) Sicherungen nur für TPD32 EV-FC-...4B-C. (2) Auf der Leistungskarte / Steuerung "FIR ...".

(1) Fusibles sólo para TPD32 EV-FC-...4B-C. (2) En la placa Potencia/Control "FIR ...".

TPD32 EV-CU...

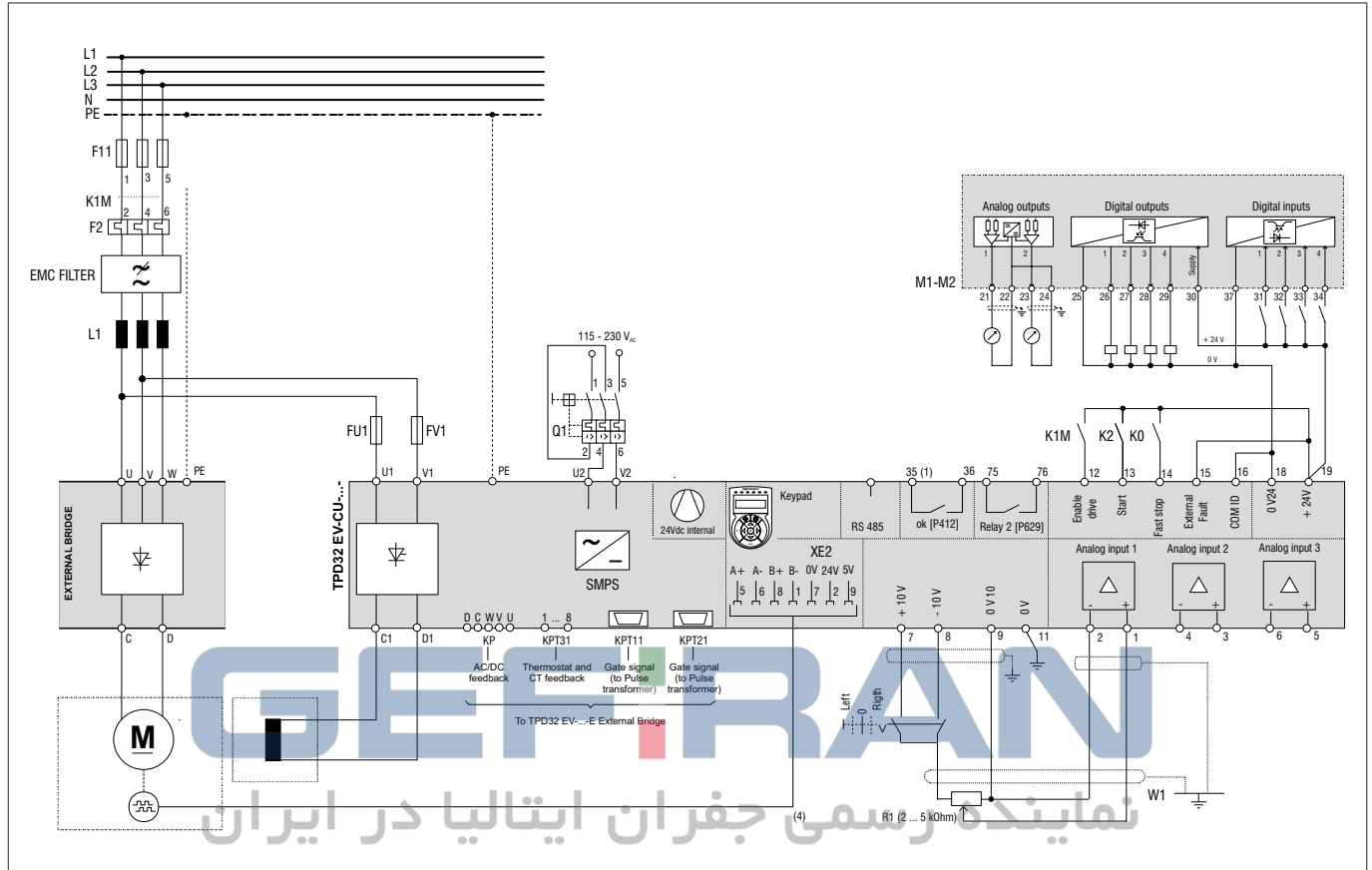

- (1) On the "FIR ..." Power/Control card.
- (1) Sulla scheda Potenza / Controllo "FIR ...".
- (1) Sur la carte Puissance / Contrôle « FIR ... ».
- (1) Auf der Leistungskarte / Steuerung "FIR ...".
- (1) En la placa Potencial/Control "FIR ...".

Block diagram of exciter with external bridge

Schema a blocchi eccitatrice con ponte esterno
 Schéma fonctionnel de l'excitateur avec pont extérieur
 Blockschaltbild Erregereinrichtung mit externer Brücke
 Diagrama de bloques de excitación con puente externo

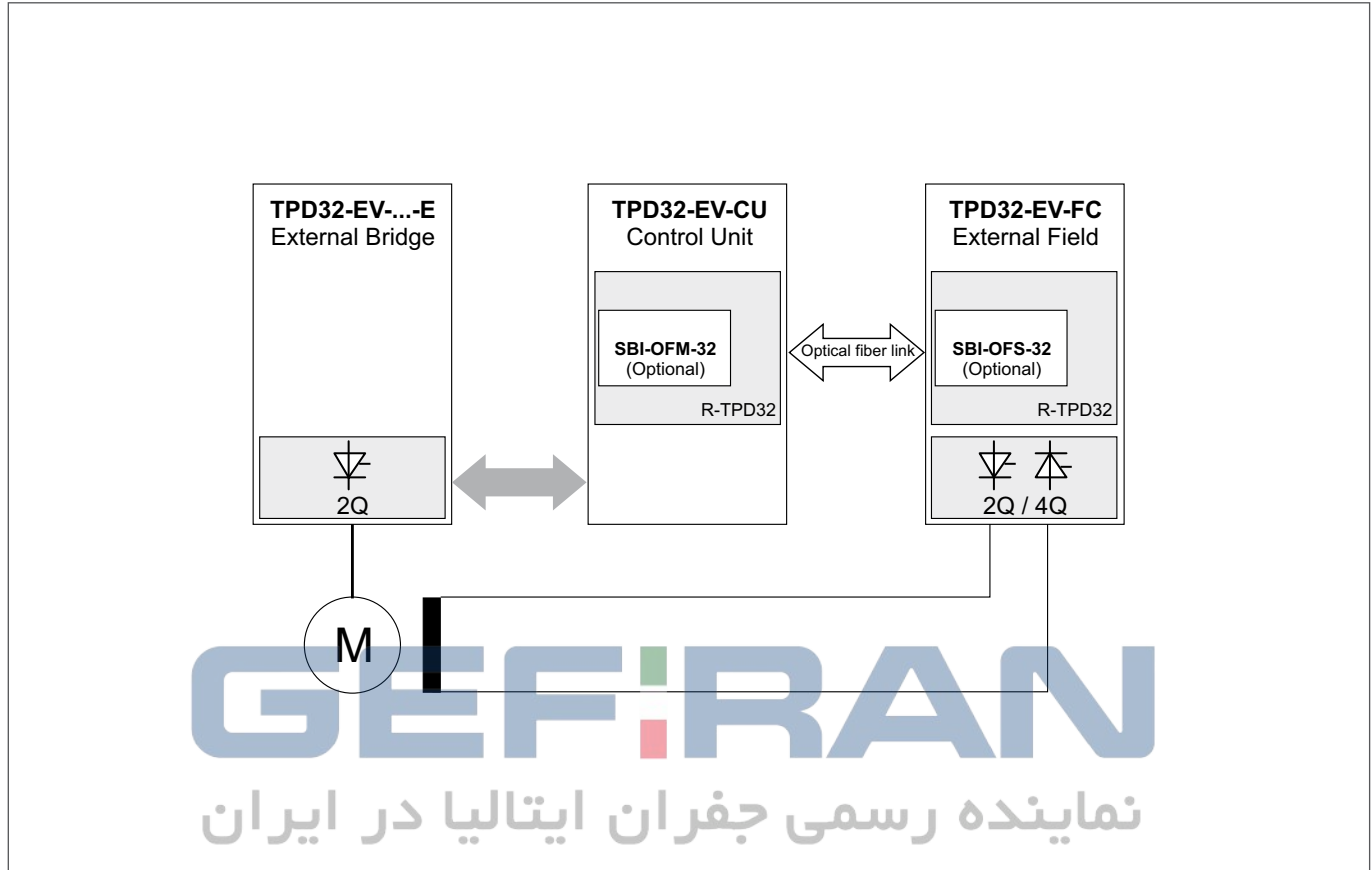

Three-phase External Exciter Control

With this function, a parameter can be enabled to use the drive in the FC configuration to control the excitation circuit of large DC motors.
 Serial communication between the armature control drive (master) and the FC drive (slave) is via optical fibre serial interface.
 The master control unit provides the flux reference for control of the three-phase bridge current of the drive connected to the motor excitation circuit in both the constant torque and constant power zones.
 Dynamic control of four-quadrant systems is also possible with a two-quadrant power and control circuit (in the 2B+e configuration) connected to the armature.



Controllo Eccitatrice Esterna Trifase

Questa funzione permette, abilitando un parametro, di utilizzare il drive in configurazione FC come controllo del circuito di eccitazione di grossi motori in corrente continua.
 La comunicazione seriale tra il drive di controllo dell'armatura (Master) e il drive FC (Slave) avviene tra una interfaccia seriale a fibre ottiche.
 Il controllo Master fornisce il riferimento di flusso che garantisce il controllo della corrente del ponte trifase del drive collegato al circuito di eccitazione del motore, sia nella zona a coppia costante che in quella a potenza costante.
 Inoltre vi è la possibilità di controllare dinamicamente un sistema a 4 quadranti anche nel caso in cui il circuito di potenza e controllo (in configurazione 2B+e), connesso all'armatura, sia biquadrante.



Contrôle de l'excitateur extérieur triphasé

Cette fonction permet, après avoir habilité un paramètre, d'utiliser le drive, dans la configuration FC, en tant que contrôle du circuit d'excitation de gros moteurs à courant continu.
 La communication série entre le drive de contrôle de l'armature (maître) et le drive FC (asservi) se fait par le biais d'une interface série à fibres optiques.
 Le contrôle maître fournit la référence de flux qui garantit le contrôle du courant du pont triphasé du drive relié au circuit d'excitation du moteur, aussi bien dans la zone à couple constant que dans la zone à puissance constante.
 À noter par ailleurs la possibilité de réaliser un contrôle dynamique d'un système à 4 quadrants, y compris dans le cas où le circuit de puissance et de contrôle (dans la configuration 2B+e), raccordé à l'armature, se composerait de deux quadrants.



Steuerung Externe dreiphasige Erregereinrichtung

Diese Funktion ermöglicht es, durch Freigabe eines Parameters den Antrieb in FC-Konfiguration zur Steuerung des Erregungskreises großer Gleichstrommotoren zu verwenden.
 Die serielle Kommunikation zwischen dem Antrieb für den Anker (Master) und den FC-Antrieb (Slave) erfolgt über eine serielle Glasfaser-Schnittstelle.
 Die Master-Steuerung liefert den Flussollwert, der die Steuerung des Stroms der dreiphasigen Antriebsbrücke garantiert, die an den Motorerregungskreis angeschlossen ist, sowohl im Bereich mit konstantem Drehmoment als auch im Bereich mit konstanter Leistung.
 Außerdem besteht die Möglichkeit, ein Vier-Quadrant-System dynamisch zu kontrollieren, auch falls der Leistungs- und Steuerkreis (in Konfiguration 2B+e), der an den Anker angeschlossen ist, ein Zwei-Quadrant-System ist.



Control de excitación externa trifásica

Activando un parámetro, esta función permite utilizar el convertidor en configuración FC como un control del circuito de excitación de grandes motores en corriente continua.
 La comunicación en serie entre el convertidor de control de la armadura (maestro) y el convertidor FC (esclavo) se produce mediante un interface serie con fibra óptica.
 El control maestro proporciona la referencia de flujo que garantiza el control de la corriente del puente trifásico del convertidor conectado al circuito de excitación del motor, tanto en la zona de par constante como en la de potencia constante.
 También existe la posibilidad de controlar dinámicamente un sistema con 4 cuadrantes también en el caso de que el circuito de potencia y control (en la configuración 2B+e), conectado a la armadura sea biquadrante.

12 Pulse DC Drives - TPD32 EV-...-12P and TPD32 EV-...-12S

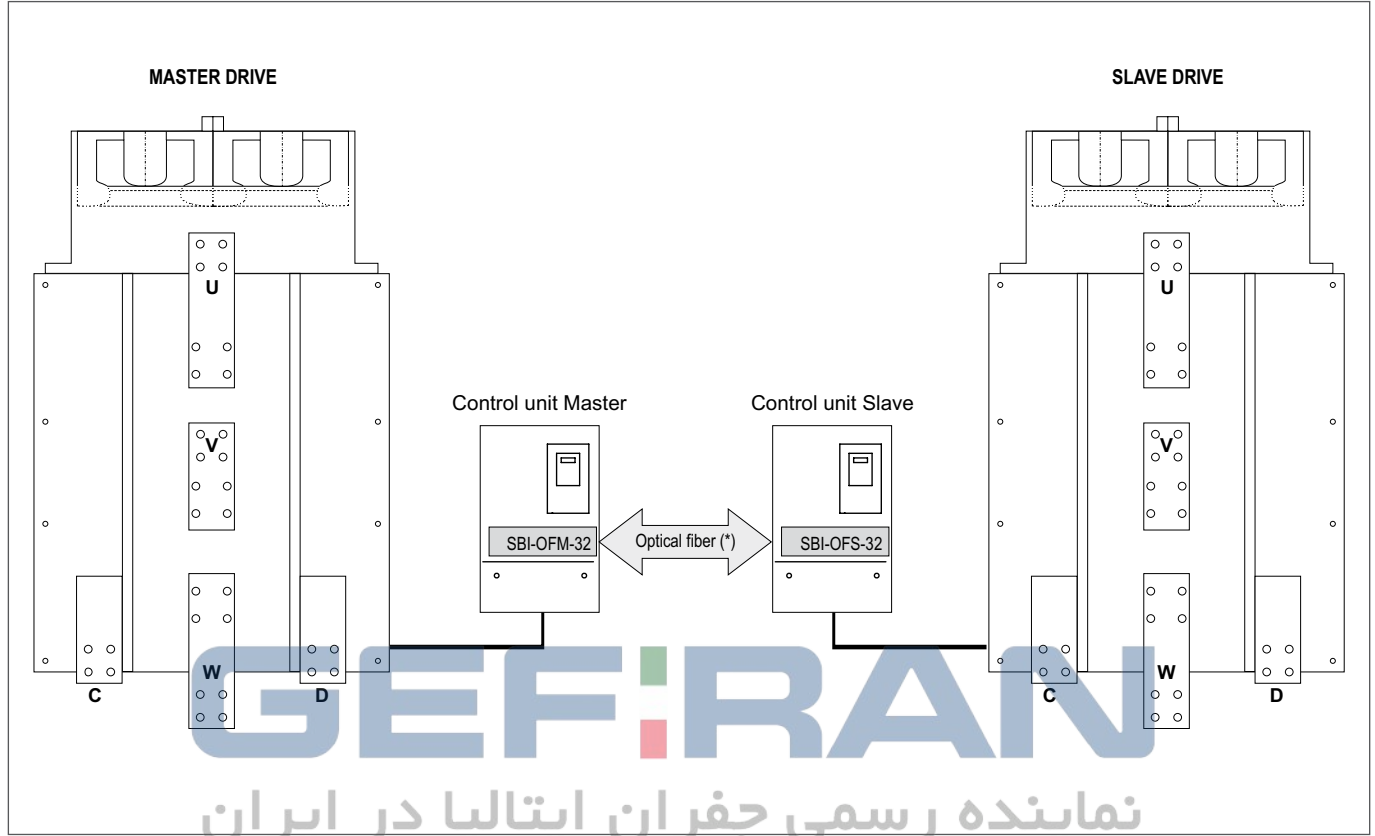

(*) S7QAE3, Master / Slave connection Optical standard cable 3 mt. (5mt. code S7QAQ8 optional on request).



The 12 pulses DC drives are composed by two 6 pulses power bridges connected in two different configuration: parallel (12P) or series (12S).

The most advantages of this technology are:

- reduction of the Harmonics level,
- motor efficiency improvement due to a current ripple reduction,
- extension of the drive power range for parallel configuration,
- possibility of emergency operation with one converter in case of a breakdown in the other converter for series configuration.

It is required to use a twelve pulse line transformer providing the AC power for both converters from separated transformer secondary windings whose phase positions differ by 30°.



Il convertitore DC a 12 impulsi è composto da due ponti a 6 impulsi collegati in due differenti configurazioni: parallelo (12P) o serie (12S).

I principali vantaggi di questa tecnologia sono:

- riduzione dei livelli delle armoniche,
- miglioramento del rendimento del motore dovuto alla riduzione dell'ondulazione della corrente,
- estensione del range di potenza dei convertitori in configurazione parallelo,
- nella configurazione serie, in caso di guasto di un convertitore è possibile il funzionamento di emergenza con un solo convertitore.

E' richiesto l'impiego di un trasformatore di linea a 12 impulsi che la potenza CA ad entrambi i convertitori da avvolgimenti secondari separati e sfasati di 30°.



Le convertisseur CC à 12 impulsions est constitué de deux ponts à 6 impulsions branchés dans deux configurations différentes : en parallèle (12P) ou en série (12S).

Les principaux avantages de cette technologie sont les suivants :

- réduction du niveau des harmoniques
- amélioration du rendement du moteur grâce à la réduction de l'ondulation du courant
- extension de la plage de puissance des convertisseurs configurés en parallèle
- sur les convertisseurs configurés en série, en cas de panne d'un convertisseur, le fonctionnement de secours est possible avec l'autre convertisseur.

Il est nécessaire d'utiliser un transformateur de ligne à 12 impulsions fournissant la puissance CA aux deux convertisseurs à partir de bobinages secondaires séparés et décalés de 30°.



Der Stromrichter ist auch in der 12-Puls Ausführung verfügbar, bestehend aus zwei 6-Puls Brücken, die in zwei unterschiedlichen Konfigurationen verbunden sind: parallel (Modell TPD32-EV-...-12P) oder Reihenschaltung (TPD32-EV-...-12S).

Die Hauptvorteile dieser Technologie sind:

- Reduzierung der Oberwellen-Niveaus,
- Verbesserung des Motorleistungsgrads dank Reduzierung der Stromwelligkeit,
- Erweiterung des Leistungsbereichs der Stromrichter in paralleler Konfiguration,
- wenn die Stromrichter in Reihe geschaltet sind, besteht bei Störung eines Stromrichters die Möglichkeit, mit dem anderen Stromrichter im Notbetrieb zu arbeiten.

Der Einsatz eines Leitungstransformators mit 12 Impulsen ist erforderlich; er liefert beiden Stromrichtern die AC-Leistung über sekundäre getrennte und um 30° versetzte Wicklungen.



El convertidor CC de 12 impulsos consta de dos puentes de 6 impulsos conectados en dos configuraciones diferentes: en paralelo (12P) o en serie (12S).

Las principales ventajas de esta tecnología son:

- reducción de los niveles de armónicos,
- mejora del rendimiento del motor debido a la reducción de la ondulación de la corriente,
- ampliación de la gama de potencia de los convertidores de la configuración en paralelo,
- en convertidores con configuración de serie, en caso de fallo de un convertidor, es posible un funcionamiento de emergencia con el otro convertidor.

Se requiere el uso de un transformador de línea de 12 impulsos que proporcione la potencia de CA a ambos convertidores con devanados secundarios, separados y desfasados en 30°.

TPD32 EV-...-12P

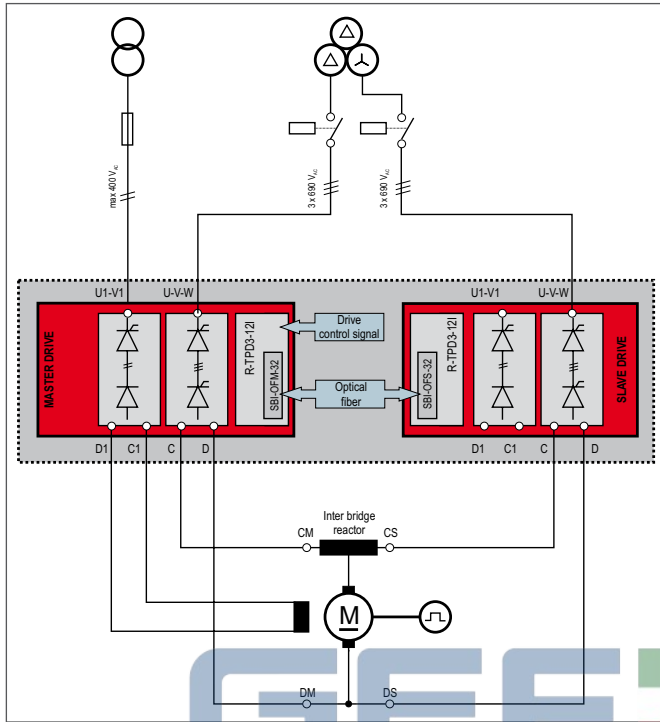

12 Pulses PARALLEL Configuration

The motor gets the sum of the DC current of two converters. Thus the current is doubled. The Power range of the drive is extended by doubling dc drive output current value. Contact Gefran Sales office for inter-bridge reactor calculation.

Configurazione a 12 impulsi PARALLELO

Al motore è fornita la somma delle correnti CC dei due convertitori, così la corrente è doppia. Il range di potenza del convertitore è ampliato raddoppiando il valore della corrente di uscita. Contattare l'ufficio Commerciale Gefran per il calcolo della reattanza interfascia necessaria.

Configuration à 12 impulsion en PARALLÈLE

Au moteur, est fournie la somme des courants CC des deux convertisseurs, de la sorte le courant est double. La plage de puissance du convertisseur est étendue en multipliant par deux le courant de sortie. Contacter le Service Gefran Sales pour le calcul de la réactance entre phase.

Konfiguration in 12-Puls Parallel

Dem Motor wird die Summe der DC-Ströme der zwei Stromrichter geliefert, auf diese Weise ist doppelter Strom vorhanden. Der Leistungsbereich des Stromrichters ist erweitert, indem der Wert des Ausgangsstroms verdoppelt wird. Zur Berechnung der zwischenphasigen Drossel wenden Sie sich bitte an das Handelsbüro Gefran Sales.

Configuración de 12 impulsos en PARALELO

El motor se alimenta de la suma de las corrientes CC de los dos convertidores, por lo que la corriente es doble. El rango de potencia del convertidor se amplía duplicando el valor de la corriente de salida. Póngase en contacto con el Departamento de Ventas de Gefran, para el cálculo de la reactancia interfase.

TPD32 EV-...-12S

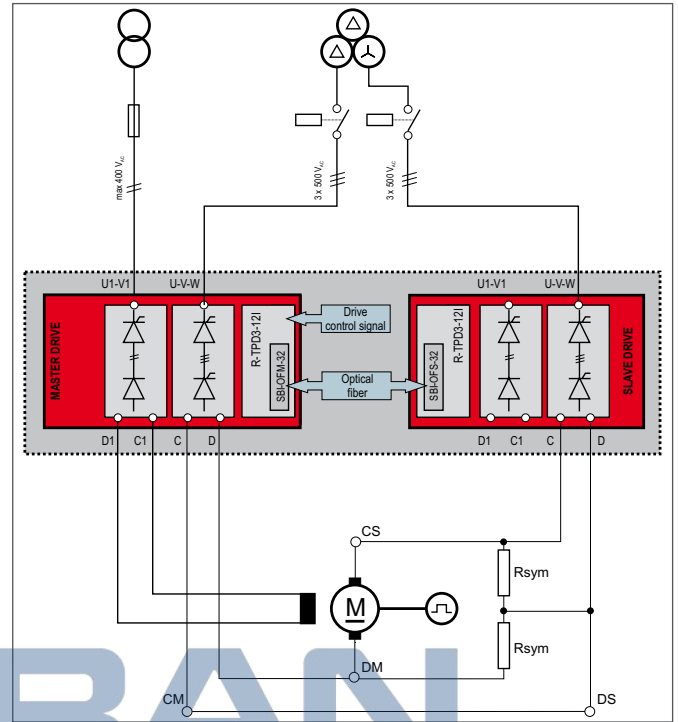

12 Pulses SERIES Configuration

The motor gets the sum of the DC voltage of two converters. Thus the voltage is doubled. An emergency operation is possible with full torque and with 50% of the former maximum armature voltage. DC voltage range is extended by doubling dc drive output voltage value. In order to divide symmetrically the total armature voltage in the range of the small armature current or armature current = 0, symmetry resistances must be utilized and connected in parallel to the individual current converters connected in series. The symmetry resistances (Rsym) should be dimensioned in such a way that a cross current of at least 100 mA flows at maximum armature voltage.

Configurazione a 12 impulsi SERIE

Il motore è alimentato dalla somma delle tensioni CC dei due convertitori, così la tensione è doppia. È possibile il funzionamento di emergenza a piena coppia e con il 50% della massima tensione di armatura. Il range di tensione del convertitore è ampliato raddoppiando il valore della tensione di uscita. Al fine di suddividere simmetricamente la tensione di armatura totale con bassi valori di corrente di armatura o armatura corrente = 0, devono essere utilizzate resistenze di simmetria e collegate in parallelo ai singoli convertitori collegati in serie. Le resistenze di simmetria (Rsym) devono essere dimensionate in modo tale che circolino una corrente di almeno 100 mA alla massima tensione di armatura.

Configuration à 12 impulsion en SÉRIE

Le moteur est alimenté par la somme des tensions CC des deux convertisseurs, de la sorte la tension est double. Le fonctionnement de secours est possible au couple max. et à 50% de la tension maximale d'armature. La plage de tension du convertisseur est étendue en multipliant par deux la valeur de la tension de sortie. Afin de répartir symétriquement la tension d'induit totale avec de faibles valeurs de courant d'induit ou d'induit courant = 0, il est nécessaire d'utiliser des résistances de symétrie, raccordées en parallèle aux différents convertisseurs reliés en série. Les résistances de symétrie (Rsym) doivent être dimensionnées de manière à ce qu'un courant d'au moins 100 mA circule à la tension maximale d'induit.

Konfiguration in 12-Puls Serie

Der Motor wird durch die Summe der DC-Spannungen der zwei Stromrichter versorgt, auf diese Weise ist doppelte Spannung vorhanden. Der Notbetrieb mit vollem Drehmoment und mit 50% der maximalen Ankerspannung ist möglich. Der Spannungsbereich des Stromrichters ist erweitert, indem der Wert der Ausgangsspannung verdoppelt wird. Zur symmetrischen Aufteilung der gesamten Ankerspannung mit niedrigen Ankerstromwerten oder einem Ankerstrom = 0 symmetrisch müssen Symmetriewiderstände verwendet und parallel an die in Reihe geschalteten einzelnen Stromrichter angeschlossen werden. Die Symmetriewiderstände (Rsym) müssen so bemessen sein, dass bei der höchsten Ankerspannung ein Strom von mindestens 100 mA fließt.

Configuración de 12 impulsos en SERIE

El motor se alimenta de la suma de las tensiones CC de los dos convertidores, por lo que la tensión es doble. Es posible el funcionamiento de emergencia en el par máximo y con el 50% de la tensión máxima de armadura. El rango de tensión del convertidor se amplía duplicando el valor de la tensión de salida. Con el fin de subdividir de manera simétrica la tensión de armadura total con valores bajos de la corriente de armadura o armadura corriente = 0, deben utilizarse resistencias de simetría y conectarse en paralelo a los convertidores individuales conectados en serie. Las resistencias de simetría (Rsym) deben dimensionarse de tal manera que circule una corriente mínima de 100 mA a la máxima tensión de armadura.

Dimensions and Weights (Compact Case - Frame A1)

Dimensioni e Pes
Dimensions et Poids

Abmessungen und Gewichte
Dimensiones y Pesos

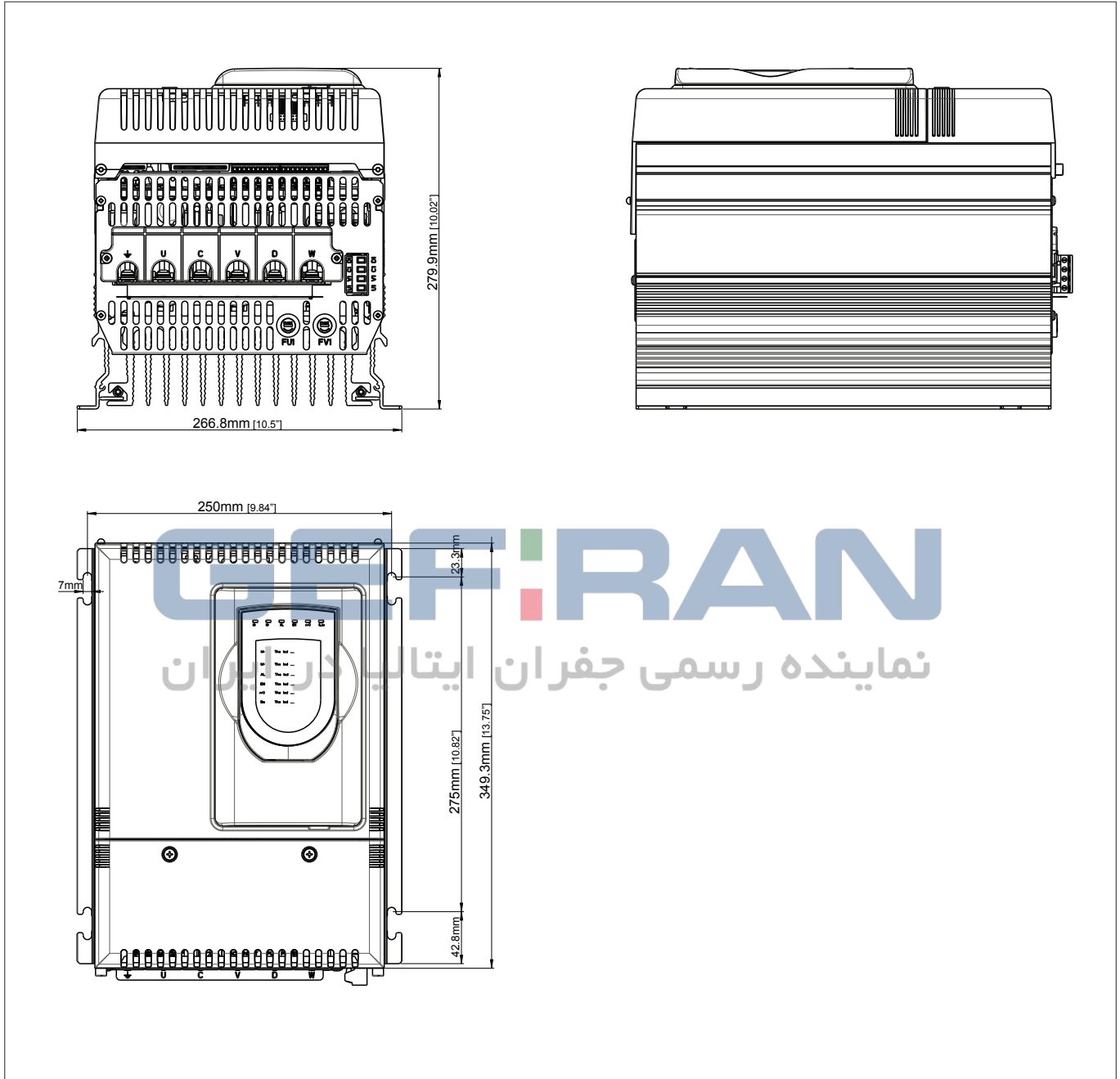

TPD32 EV European Drive Rating	TPD32 EV-...-NA American Drive Rating	Frame	Weight kg [lbs]
TPD32-EV-.../...-20-...-A	TPD32-EV-.../...-17-...-A-NA	A1	11 [24.3]
TPD32-EV-.../...-40-...-A	TPD32-EV-.../...-35-...-A-NA	A1	11 [24.3]

Dimensions and Weights (Compact Case - Frame A2)

Dimensioni e Pes
Dimensions et Poids

Abmessungen und Gewichte
Dimensiones y Pesos

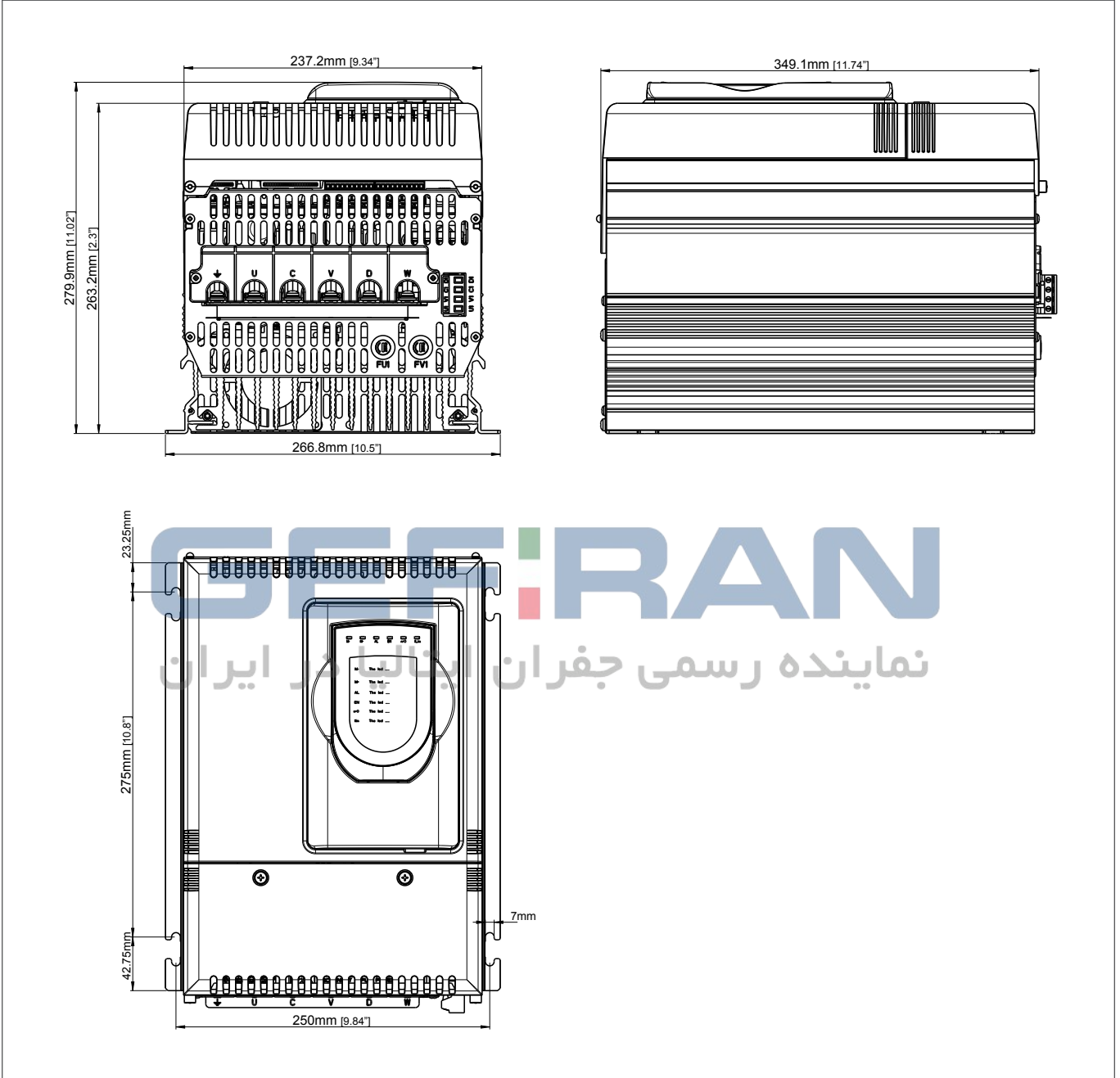

TPD32 EV European Drive Rating	TPD32 EV-...-NA American Drive Rating	Frame	Weight kg [lbs]
TPD32-EV-.../...-70-...-A	TPD32-EV-.../...-56-...-A-NA	A2	11.5 [25.4]

Dimensions and Weights (Compact Case - Frame A3)

Dimensioni e Pes
Dimensions et Poids

Abmessungen und Gewichte
Dimensiones y Pesos

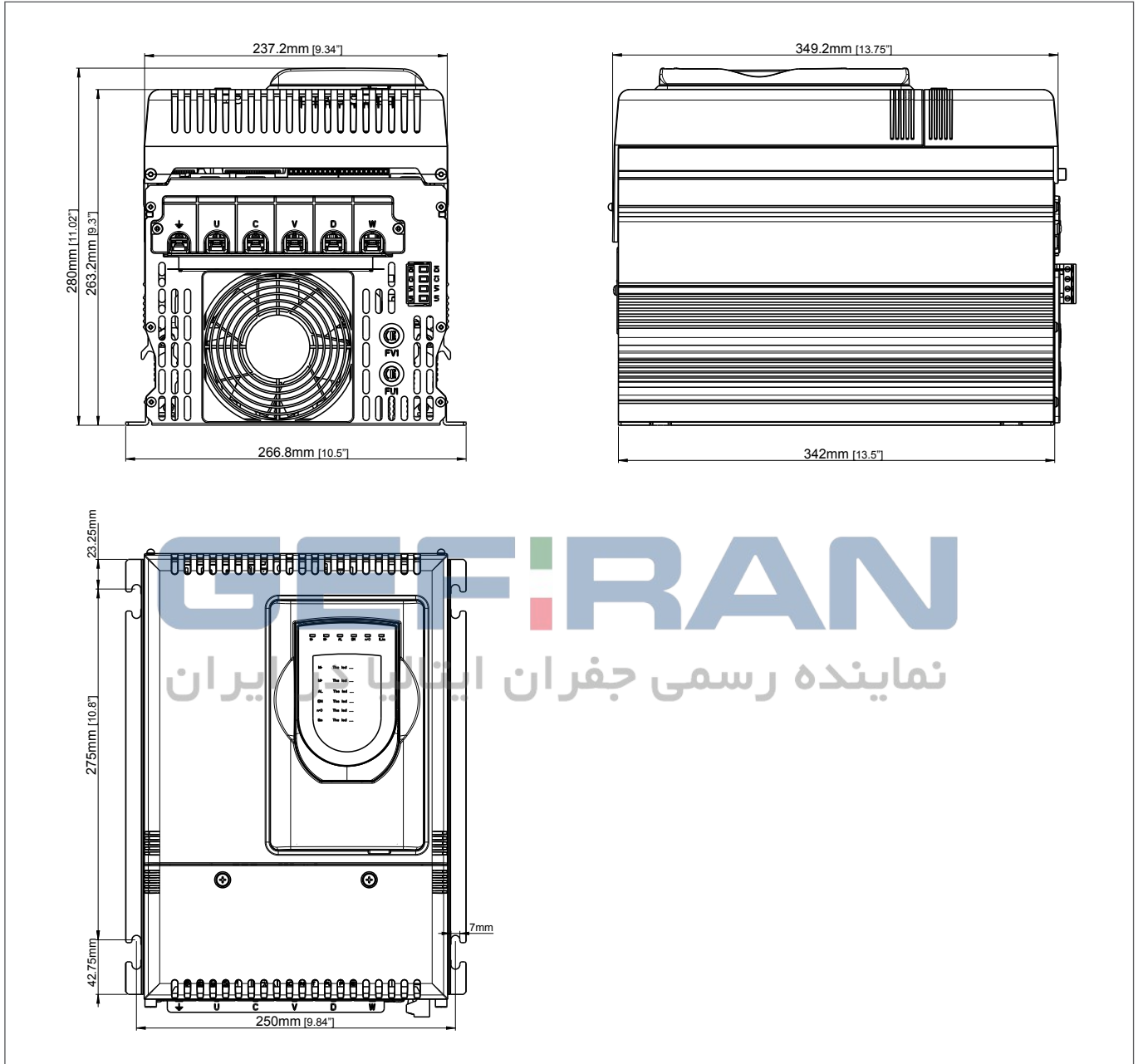

Technical Specifications

TPD32 EV European Drive Rating	TPD32 EV-...-NA American Drive Rating	Frame	Weight kg [lbs]
TPD32-EV-.../...-110-...-A	TPD32-EV-.../...-88-...-A-NA	A3	12 [26.5]
TPD32-EV-.../...-140-...-A	TPD32-EV-.../...-112-...-A-NA	A3	12 [26.5]
TPD32-EV-.../...-185-...-A	TPD32-EV-.../...-148-...-A-NA	A3	12 [26.5]

Dimensions and Weights (Compact Case - Frame B1)

Dimensioni e Pes
Dimensions et Poids

Abmessungen und Gewichte
Dimensiones y Pesos

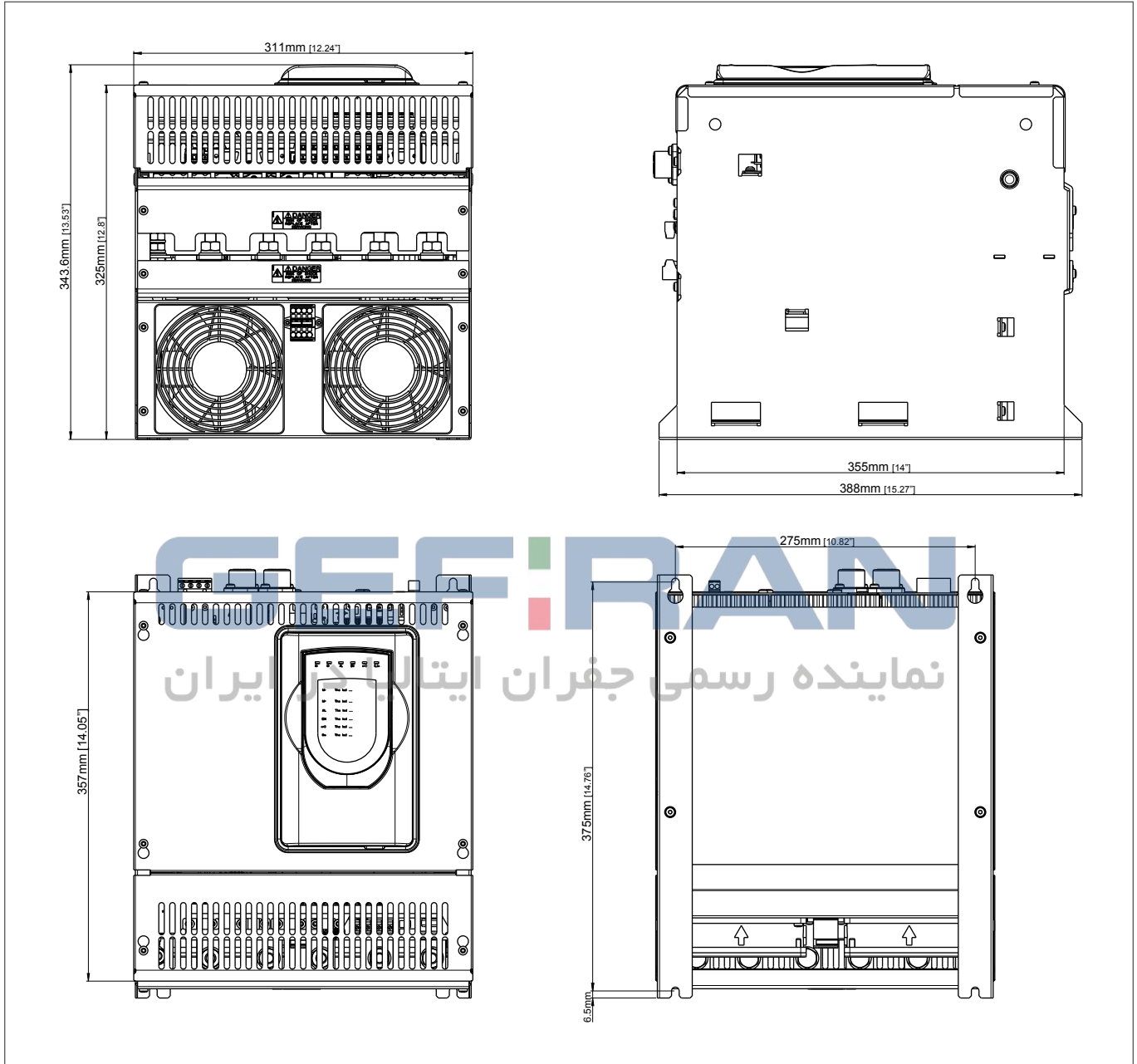

TPD32 EV European Drive Rating	TPD32 EV-...-NA American Drive Rating	Frame	Weight kg [lbs]
TPD32-EV-.../...-280-...-B	TPD32-EV-.../...-224-...-B-NA	B1	26 [57.3]
TPD32-EV-.../...-350-...-B	TPD32-EV-.../...-280-...-B-NA	B1	26 [57.3]
TPD32-EV-.../...-420-...-B	TPD32-EV-.../...-336-...-B-NA	B1	26 [57.3]
TPD32-EV-.../...-500-...-B	TPD32-EV-.../...-400-...-B-NA	B1	26 [57.3]

Dimensions and Weights (Compact Case - Frame B2)

Dimensioni e Pes
Dimensions et Poids

Abmessungen und Gewichte
Dimensiones y Pesos

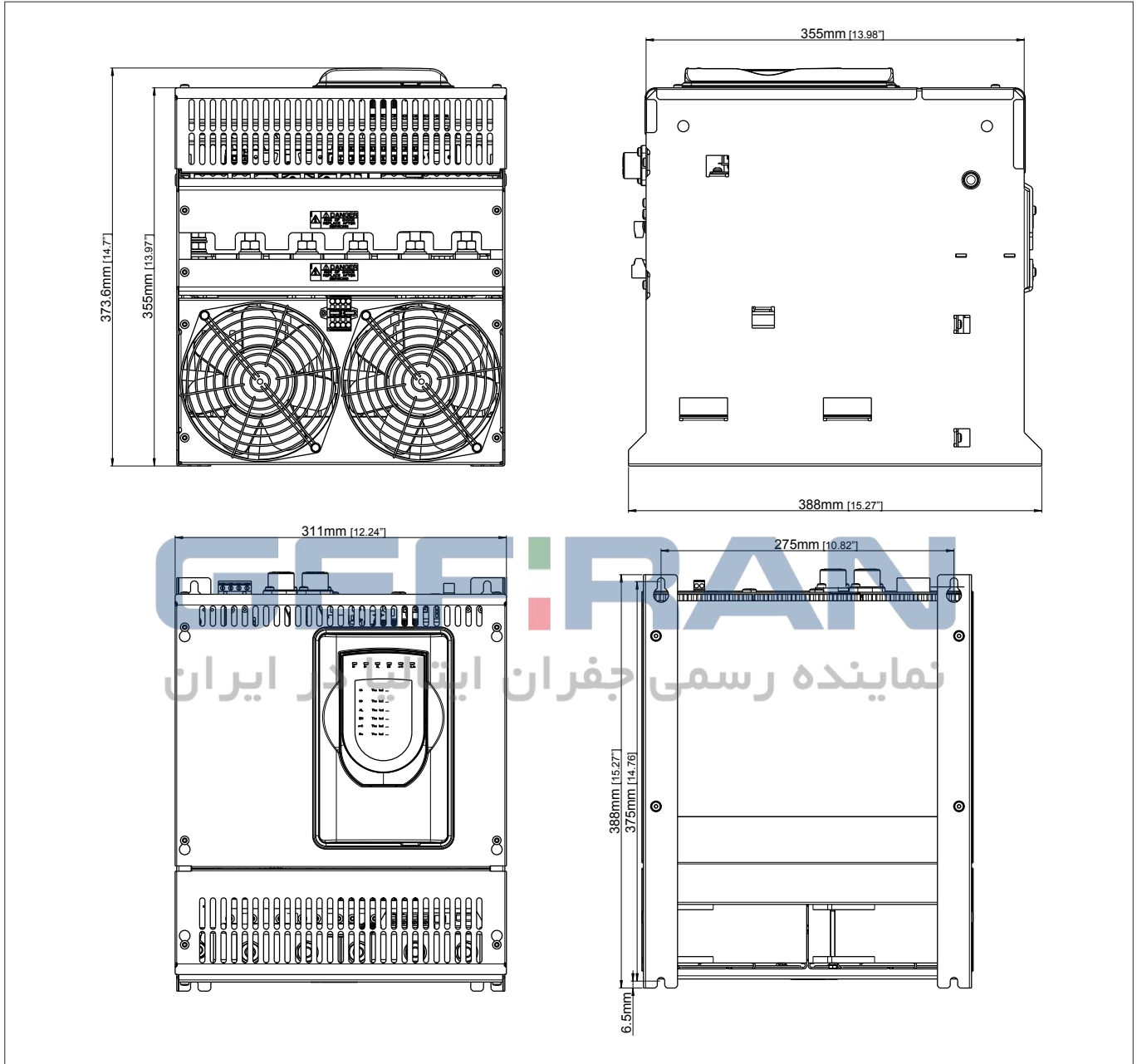

TPD32 EV European Drive Rating	TPD32 EV-...-NA American Drive Rating	Frame	Weight kg [lbs]
TPD32-EV-.../...-650-...-B	TPD32-EV-.../...-450-...-B-NA	B2	32 [70.5]

Dimensions and Weights (Compact Case - Frame C)

Dimensioni e Pesi
Dimensiones et Poids

Abmessungen und Gewichte
Dimensiones y Pesos

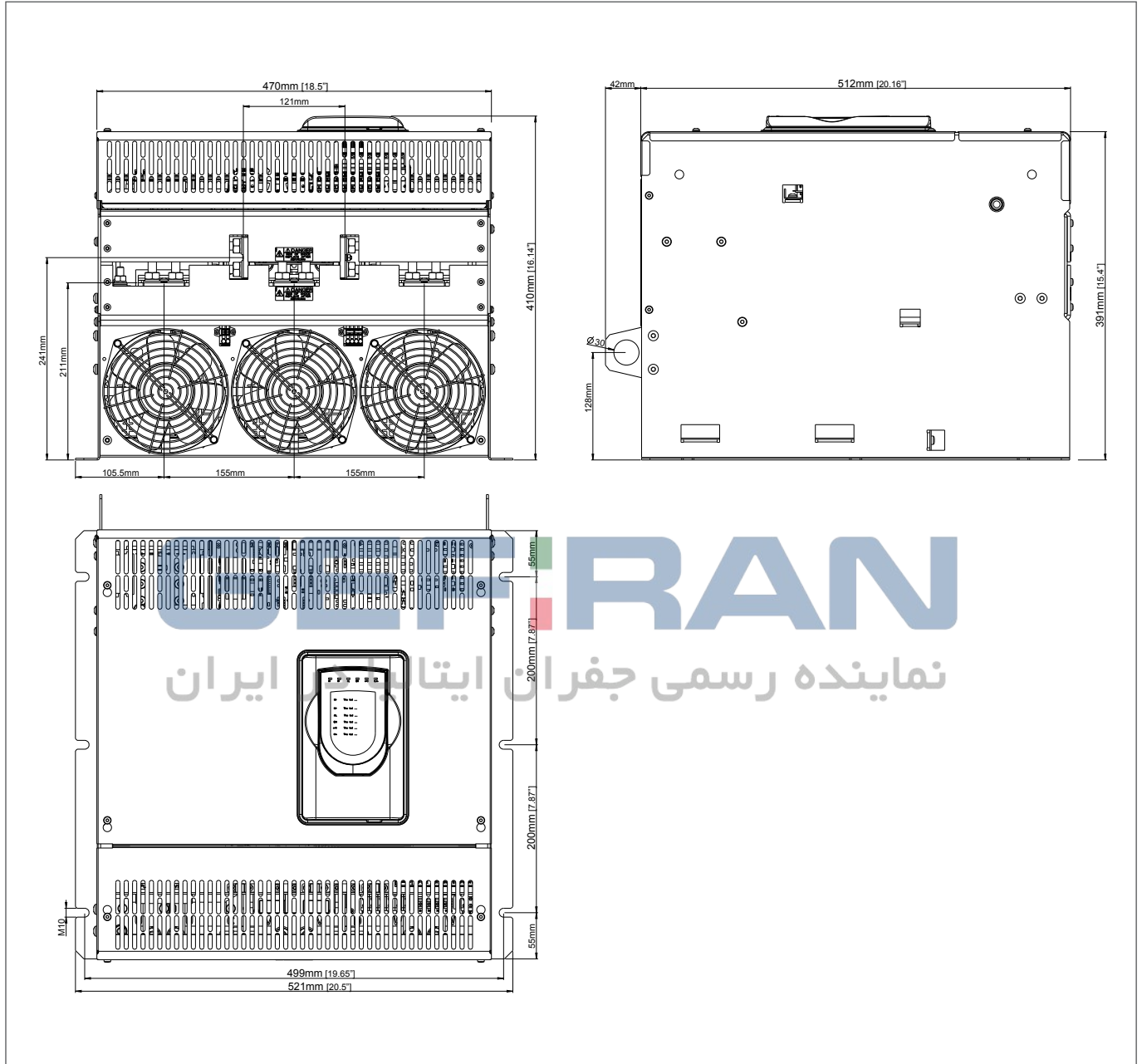

TPD32 EV European Drive Rating	TPD32 EV-...-NA American Drive Rating	Frame	Weight kg [lbs]
TPD32-EV-.../...-560-...-C	TPD32-EV-.../...-360-...-C-NA	C	61 [134.5]
TPD32-EV-.../...-700-...-C	TPD32-EV-.../...-490-...-C-NA	C	61 [134.5]
TPD32-EV-.../...-770-...-C	TPD32-EV-.../...-560-...-C-NA	C	61 [134.5]
TPD32-EV-.../...-900-...-C	TPD32-EV-.../...-650-...-C-NA	C	65 [143.3]
TPD32-EV-.../...-1000-...-C TPD32-EV-.../...-1050-...-C	TPD32-EV-575/...-750-...-C-NA TPD32-EV-500/...-800-...-C-NA TPD32-EV-500/...-850-...-C-NA	C	72 [158.7]

Dimensions and Weights (Compact Case - Frame D)

Dimensioni e Pes
Dimensions et Poids

Abmessungen und Gewichte
Dimensiones y Pesos

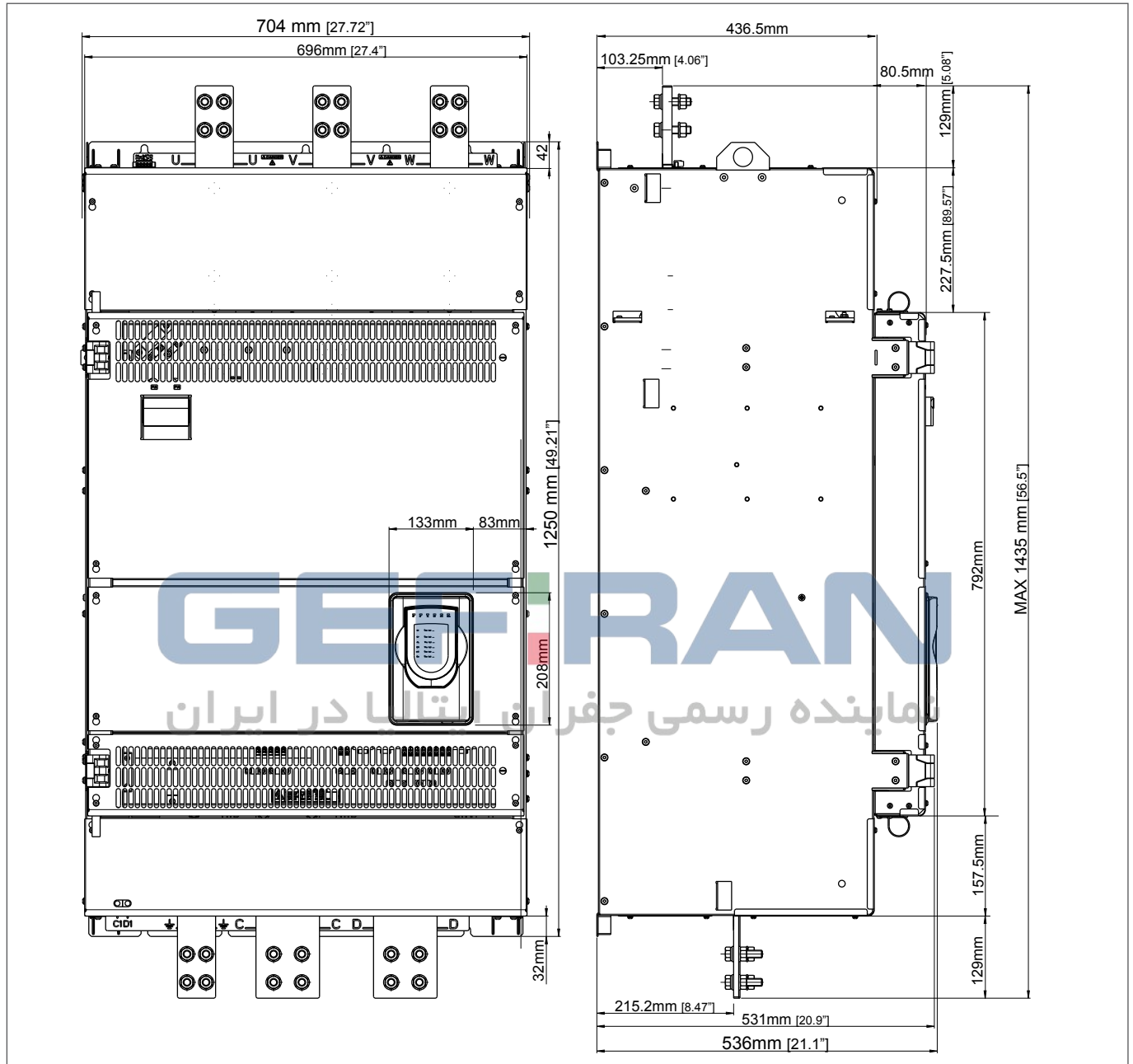

TPD32 EV European Drive Rating	TPD32 EV-...-NA American Drive Rating	Frame	Weight - kg [lbs]	
			2B	4B
TPD32-EV-.../...-1300-...	TPD32-EV-.../...-920-...-NA	D	152 [335.1]	203 [447.5]
TPD32-EV-.../...-1300-...	TPD32-EV-575/...-980-...-NA	D	152 [335.1]	203 [447.5]
TPD32-EV-.../...-1400-...	TPD32-EV-.../...-1000-...-NA	D	165 [363.8]	215 [474.0]
TPD32-EV-.../...-1600-...	TPD32-EV-.../...-1200-...-NA	D	165 [363.8]	215 [474.0]
TPD32-EV-.../...-1900-...	TPD32-EV-.../...-1450-...-NA	D	165 [363.8]	215 [474.0]
TPD32-EV-.../...-2000-...	TPD32-EV-.../...-1500-...-NA	D	165 [363.8]	215 [474.0]
TPD32-EV-.../...-2100-...	TPD32-EV-.../...-1650-...-NA	D	191 [421.1]	241 [531.3]
TPD32-EV-.../...-2300-...	TPD32-EV-.../...-1800-...-NA	D	191 [421.1]	241 [531.3]
TPD32-EV-.../...-2400-...	TPD32-EV-.../...-1850-...-NA	D	191 [421.1]	241 [531.3]

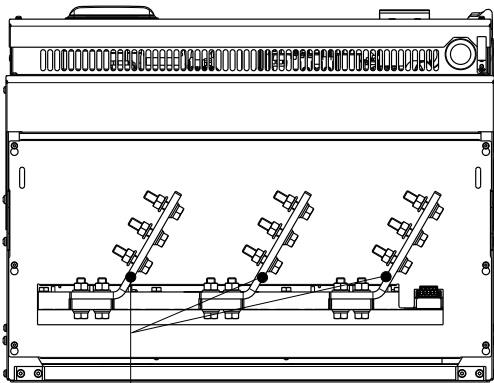
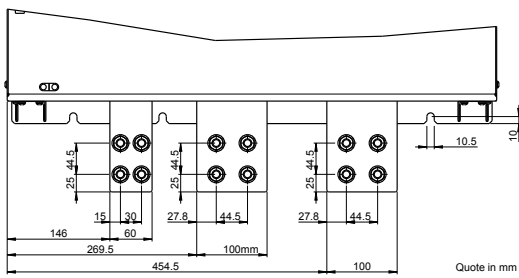
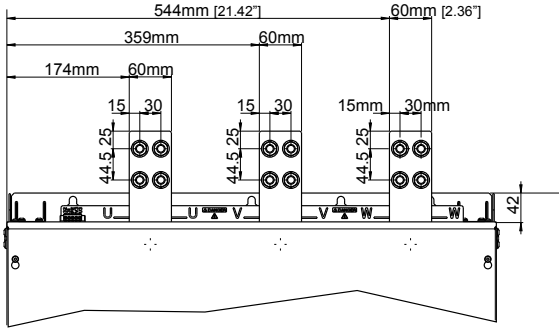

OPTIONAL U/V/W BARS

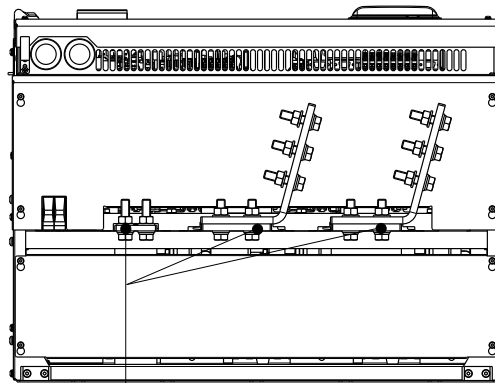

OPTIONAL C/D BARS

GEFIRAN

نماینده رسمی جفران ایتالیا در ایران

Dimensions and Weights (External bridge, European sizes - Frame E)

Dimensioni e Pesì
Dimensions et Poids
Abmessungen und Gewichte
Dimensiones y Pesos

The 12 pulses DC drives are composed by two identical bridges and two Control Units, the dimensions and weight showed below refers to one bridge only.

I convertitori DC a 12 impulsi sono composti da 2 ponti esterni e 2 Unità di Controllo identiche, le dimensioni e i pesi indicati sotto si riferiscono a un solo ponte.

Les convertisseurs CC à 12 impulsions sont constitués de 2 ponts externes et de 2 unités de contrôle identiques ; les dimensions et les poids indiqués ci-dessous se réfèrent à un seul pont.

Die DC-Stromrichter mit 12 Impulsen bestehen aus 2 externen Brücken und 2 identischen Steuereinheiten, die unten angegebenen Maße und Gewichte beziehen sich auf eine einzige Brücke.

Los convertidores CC de 12 impulsos constan de 2 puentes externos y 2 unidades de control idénticas; las dimensiones y los pesos que se muestran a continuación se refieren a un solo puente.

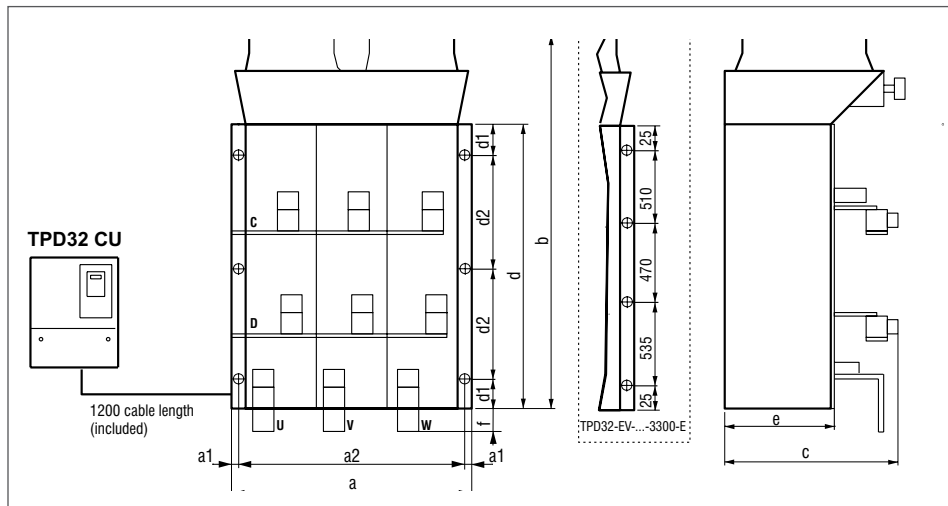

TPD32 EV-...-2B-E European Drive Rating	a mm [inches]	b mm [inches]	c mm [inches]	d mm [inches]	e mm [inches]	f mm [inches]	a1 mm [inches]	a2 mm [inches]	d1 mm [inches]	d2 mm [inches]	Weight (l) kg [lbs.]
TPD32 EV-690/840-1010-2B	500 [19.7]	760 [29.9]	275 [10.8]	550 [21.7]	153 [6.0]	95 [3.7]	10 [0.39]	480 [18.9]	50 [2.0]	225 [8.9]	70 [154.3]
TPD32 EV-500/600-1200-2B	500 [19.7]	570 [22.4]	275 [10.8]	360 [14.2]	153 [6.0]	75 [3.0]	10 [0.39]	480 [18.9]	50 [2.0]	-	65 [143.3]
TPD32 EV-690/840-1400-2B	500 [19.7]	760 [29.9]	275 [10.8]	550 [21.7]	153 [6.0]	95 [3.7]	10 [0.39]	480 [18.9]	50 [2.0]	225 [8.9]	70 [154.3]
TPD32 EV-500/600-1500-2B	500 [19.7]	760 [29.9]	275 [10.8]	550 [21.7]	153 [6.0]	95 [3.7]	10 [0.39]	480 [18.9]	50 [2.0]	225 [8.9]	70 [154.3]
TPD32 EV-690/840-1700-2B	620 [24.4]	764 [30.1]	360 [14.2]	550 [21.7]	233 [9.2]	95 [3.7]	10 [0.39]	600 [23.6]	50 [2.0]	225 [8.9]	100 [220.5]
TPD32 EV-500/600-1800-2B	500 [19.7]	760 [29.9]	275 [10.8]	550 [21.7]	153 [6.0]	95 [3.7]	10 [0.39]	480 [18.9]	50 [2.0]	225 [8.9]	70 [154.3]
TPD32 EV-500/600-2000-2B	500 [19.7]	760 [29.9]	275 [10.8]	550 [21.7]	153 [6.0]	95 [3.7]	10 [0.39]	480 [18.9]	50 [2.0]	225 [8.9]	70 [154.3]
TPD32 EV-690/840-2000-2B	620 [24.4]	764 [30.1]	360 [14.2]	550 [21.7]	233 [9.2]	95 [3.7]	10 [0.39]	600 [23.6]	50 [2.0]	225 [8.9]	100 [220.5]
TPD32 EV-500/600-2400-2B	620 [24.4]	764 [30.1]	360 [14.2]	550 [21.7]	233 [9.2]	95 [3.7]	10 [0.39]	600 [23.6]	50 [2.0]	225 [8.9]	100 [220.5]
TPD32 EV-690/840-2400-2B	712 [28.0]	775 [30.5]	395 [15.6]	560 [22.2]	255 [10.0]	95 [3.7]	10 [0.39]	692 [27.2]	50 [2.0]	230 [9.1]	140 [308.6]
TPD32 EV-500/600-2700-2B	712 [28.0]	785 [30.9]	395 [15.6]	660 [26.0]	255 [10.0]	95 [3.7]	10 [0.39]	692 [27.2]	50 [2.0]	280 [11.0]	140 [308.6]
TPD32 EV-690/840-2700-2B	712 [28.0]	775 [30.5]	395 [15.6]	560 [22.2]	255 [10.0]	95 [3.7]	10 [0.39]	692 [27.2]	50 [2.0]	230 [9.1]	140 [308.6]
TPD32 EV-500/600-2900-2B	712 [28.0]	775 [30.5]	395 [15.6]	560 [22.2]	255 [10.0]	140 [5.5]	10 [0.39]	692 [27.2]	50 [2.0]	230 [9.1]	140 [308.6]
TPD32 EV-500/600-3300-2B	780 [30.7]	1180 [46.5]	420 [16.5]	875 [34.4]	295 [11.6]	125 [4.9]	25 [1.0]	730 [28.7]	25 [1.0]	300 [11.8]	260 [573.2]
TPD32 EV-690/840-3300-2B	780 [30.7]	1180 [46.5]	420 [16.5]	875 [34.4]	295 [11.6]	125 [4.9]	25 [1.0]	730 [28.7]	25 [1.0]	300 [11.8]	260 [573.2]

TPD32 EV-...-4B-E European Drive Rating	a mm [inches]	b mm [inches]	c mm [inches]	d mm [inches]	e mm [inches]	f mm [inches]	a1 mm [inches]	a2 mm [inches]	d1 mm [inches]	d2 mm [inches]	Weight (l) kg [lbs.]
TPD32 EV-690/720-1010-4B	500 [19.7]	1310 [51.6]	375 [14.8]	550 [21.7]	153 [6.0]	95 [3.7]	10 [0.39]	480 [18.9]	50 [2.0]	225 [8.9]	130 [286.6]
TPD32 EV-690/720-1400-4B	500 [19.7]	1310 [51.6]	375 [14.8]	550 [21.7]	153 [6.0]	95 [3.7]	10 [0.39]	480 [18.9]	50 [2.0]	225 [8.9]	130 [286.6]
TPD32 EV-500/520-1500-4B	500 [19.7]	1310 [51.6]	375 [14.8]	550 [21.7]	153 [6.0]	95 [3.7]	10 [0.39]	480 [18.9]	50 [2.0]	225 [8.9]	130 [286.6]
TPD32 EV-500/520-1700-4B	500 [19.7]	1310 [51.6]	375 [14.8]	550 [21.7]	153 [6.0]	95 [3.7]	10 [0.39]	480 [18.9]	50 [2.0]	225 [8.9]	130 [286.6]
TPD32 EV-690/720-1700-4B	620 [24.4]	1314 [51.7]	475 [18.7]	550 [21.7]	233 [9.2]	95 [3.7]	10 [0.39]	600 [23.6]	50 [2.0]	225 [8.9]	170 [374.8]
TPD32 EV-500/520-2000-4B	500 [19.7]	1310 [51.6]	375 [14.8]	550 [21.7]	153 [6.0]	95 [3.7]	10 [0.39]	480 [18.9]	50 [2.0]	225 [8.9]	130 [286.6]
TPD32 EV-690/720-2000-4B	620 [24.4]	1314 [51.7]	475 [18.7]	550 [21.7]	233 [9.2]	95 [3.7]	10 [0.39]	600 [23.6]	50 [2.0]	225 [8.9]	170 [374.8]
TPD32 EV-500/520-2400-4B	620 [24.4]	1314 [51.7]	495 [19.5]	550 [21.7]	233 [9.2]	95 [3.7]	10 [0.39]	600 [23.6]	50 [2.0]	225 [8.9]	170 [374.8]
TPD32 EV-690/720-2400-4B	712 [28.0]	1335 [52.6]	475 [18.7]	560 [22.0]	255 [10.0]	95 [3.7]	10 [0.39]	692 [27.2]	50 [2.0]	230 [9.1]	240 [529.1]
TPD32 EV-500/520-2700-4B	712 [28.0]	1535 [60.4]	490 [19.3]	660 [26.0]	255 [10.0]	100 [3.9]	10 [0.39]	692 [27.2]	50 [2.0]	280 [11.0]	240 [529.1]
TPD32 EV-690/720-2700-4B	712 [28.0]	1335 [60.4]	475 [18.7]	560 [22.0]	255 [10.0]	95 [3.7]	10 [0.39]	692 [27.2]	50 [2.0]	230 [9.1]	240 [529.1]
TPD32 EV-.../...-3300-4B	780 [30.7]	1890 [74.4]	470 [18.5]	1585 [62.4]	315 [12.4]	-	25 [1.0]	730 [28.7]	-	-	435 [959]

Dimensions and Weights

Control Unit for External bridge, Frame A1)

Dimensioni e Pes
Dimensions et Poids

Abmessungen und Gewichte
Dimensiones y Pesos

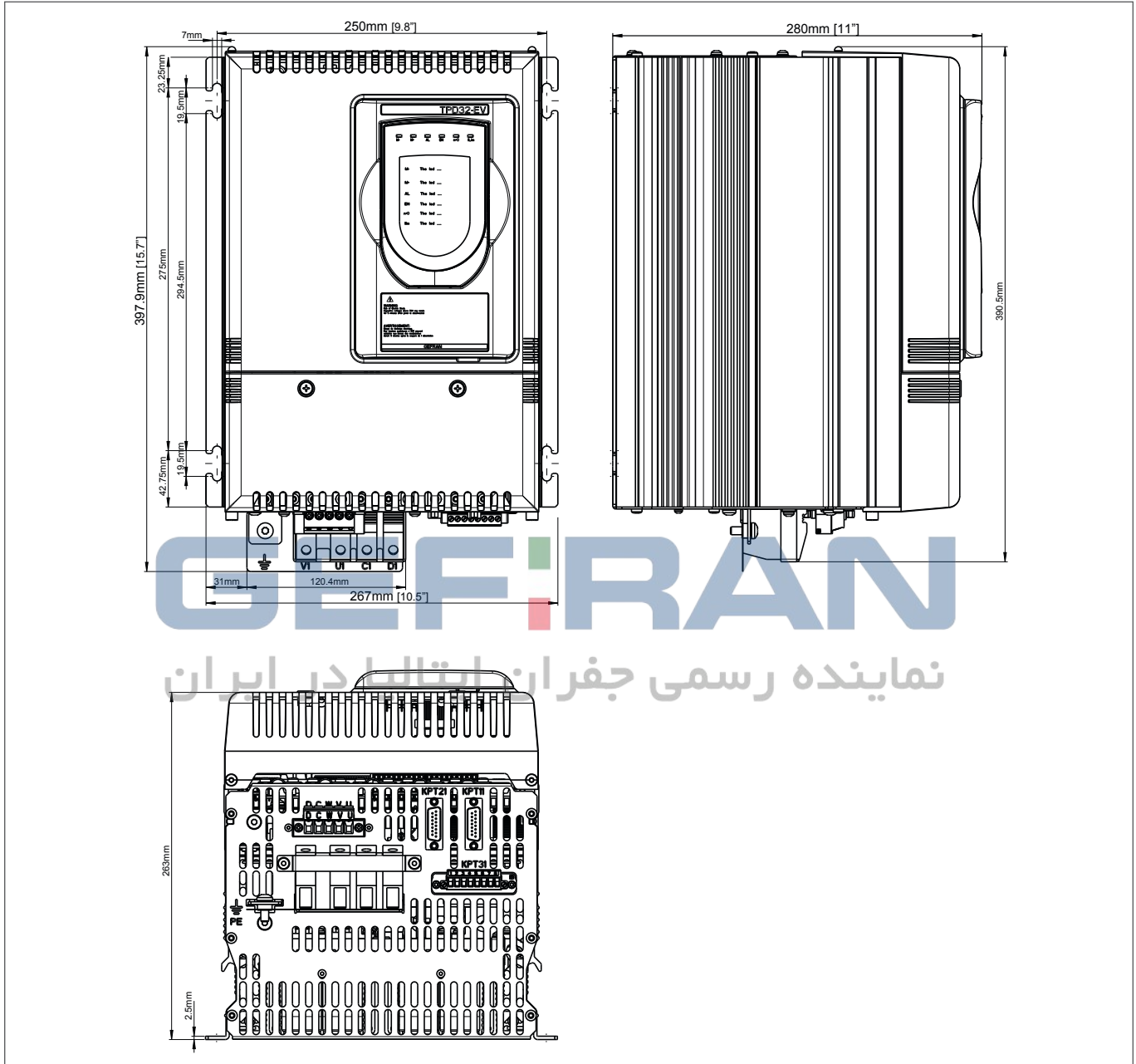

TPD32 EV-CU Control Unit for External Bridge	Frame	Weight kg [lbs]
TPD32-EV-CU-.../...-THY1-40	A1	11 [24.3]
TPD32-EV-CU-.../...-THY2-40	A1	11 [24.3]
TPD32-EV-CU-.../...-THY1-70	A1	11 [24.3]
TPD32-EV-CU-.../...-THY2-70	A1	11 [24.3]

Converter Dissipation and Fan Flow

Dissipazione Convertitore e Portata Ventilatori
 Dissipation du Convertisseurs et Débit des Ventilateurs
 Digitalstromrichterserie-Verlustleistung und Lüfterleistung
 Disipación del Convertidores digitales y Ventilación forzada

TPD32 EV European Drive Rating	TPD32 EV-...-NA American Drive Rating	PV Heat dissipation [W]	Fans		
			Voltage [V]	Rated current [A]	Air capacity [m3/h]
TPD32-EV-.../...-20-...-A	TPD32-EV-.../...-17-...-A	131	-	-	-
TPD32-EV-.../...-40-...-A	TPD32-EV-.../...-35-...-A	186	-	-	-
TPD32-EV-.../...-70-...-A	TPD32-EV-.../...-56-...-A	254	Int.supply	Int.supply	80
TPD32-EV-.../...-110-...-A	TPD32-EV-.../...-88-...-A	408	Int.supply	Int.supply	160
TPD32-EV-.../...-140-...-A	TPD32-EV-.../...-112-...-A	476	Int.supply	Int.supply	160
TPD32-EV-.../...-185-...-A	TPD32-EV-.../...-148-...-A	553	Int.supply	Int.supply	160
TPD32-EV-.../...-280-...-B	TPD32-EV-.../...-224-...-B	781	Int.supply	Int.supply	320
TPD32-EV-.../...-350-...-B	TPD32-EV-.../...-280-...-B	939	Int.supply	Int.supply	320
TPD32-EV-.../...-420-...-B	TPD32-EV-.../...-336-...-B	1038	Int.supply	Int.supply	320
TPD32-EV-.../...-500-...-B	TPD32-EV-.../...-400-...-B	1248	Int.supply	Int.supply	320
TPD32-EV-.../...-650-...-B	TPD32-EV-.../...-450-...-B	1693	Int.supply	Int.supply	680
TPD32-EV-.../...-560-...-C	TPD32-EV-.../...-360-...-C	2372	1ph 230	1	1050
TPD32-EV-.../...-700-...-C	TPD32-EV-.../...-490-...-C	3085	1ph 230	1	1050
TPD32-EV-.../...-770-...-C	TPD32-EV-.../...-560-...-C	2143	1ph 230	1	1050
TPD32-EV-.../...-900-...-C	TPD32-EV-.../...-650-...-C	3384	1ph 230	1	1050
TPD32-EV-575/...-1000-2B-C	TPD32-EV-.../...-750-2B-C	2986	1ph 230	1	1050
TPD32-EV-575/...-1050-4B-C	TPD32-EV-575...-750-4B-C	3103	1ph 230	1	1050
TPD32-EV-500/...-1000-...-C	TPD32-EV-.../...-800-...-C	2590	1ph 230	1	1050
TPD32-EV-500/...-1050-4B-C	TPD32-EV-.../...-850-4B-C	2590	1ph 230	1	1050
TPD32-EV-690/...-1300-2B-D	TPD32-EV-.../...-920-2B-D	6175	3 ph 400/460	1.25 (50Hz) / 1.55 (60Hz)	
TPD32-EV-575/...-1300-...-D	TPD32-EV-.../...-980-...-D	4863	3 ph 400/460	1.25 (50Hz) / 1.55 (60Hz)	
TPD32-EV-.../...-1400-...-D	TPD32-EV-.../...-1000-...-D	5142	3 ph 400/460	1.25 (50Hz) / 1.55 (60Hz)	
TPD32-EV-.../...-1600-...-D	TPD32-EV-.../...-1200-...-D	6225	3 ph 400/460	1.25 (50Hz) / 1.55 (60Hz)	
TPD32-EV-.../...-1900-...-D	TPD32-EV-.../...-1450-...-D	7598	3 ph 400/460	1.25 (50Hz) / 1.55 (60Hz)	2900 (400W/50Hz)
TPD32-EV-.../...-2000-...-D	TPD32-EV-.../...-1500-...-D	7238	3 ph 400/460	1.25 (50Hz) / 1.55 (60Hz)	3400 (460W/60Hz)
TPD32-EV-.../...-2100-...-D	TPD32-EV-.../...-1650-...-D	8032	3 ph 400/460	1.25 (50Hz) / 1.55 (60Hz)	
TPD32-EV-.../...-2300-...-D	TPD32-EV-.../...-1800-...-D	7480	3 ph 400/460	1.25 (50Hz) / 1.55 (60Hz)	
TPD32-EV-.../...-2400-...-D	TPD32-EV-.../...-1850-...-D	7343	3 ph 400/460	1.25 (50Hz) / 1.55 (60Hz)	
TPD32 EV-.../...-1010-...-E	-	3500	1ph 230	0.4	900
TPD32 EV-.../...-1050-...-E	TPD32 EV-.../...-800-...-NA	2590	1ph 230	0.75	1050
TPD32 EV-.../...-1000-...-E	TPD32 EV-.../...-850-...-NA	2590	1ph 230	0.75	1050
TPD32 EV-.../...-1200-...-E		3500	1ph 230	0.4	900
TPD32 EV-.../...-1400-...-E		4900	1ph 230	0.4	900
TPD32 EV-.../...-1500-...-E		4900	1ph 230	0.4	900
TPD32 EV-500/520-1700-...-E		5200	1ph 230	0.4	900
TPD32 EV-690/810-1700-...-E		6700	1ph 230	0.6	1450
TPD32 EV-.../...-1800-...-E		5200	1ph 230	0.4	900
TPD32 EV-500/520-2000-...-E		5400	1ph 230	0.4	900
TPD32 EV-690/810-2000-...-E		6800	1ph 230	0.6	1450
TPD32 EV-500/220-2400-...-E		6800	1ph 230	0.6	1450
TPD32 EV-690/810-2400-...-E		8000	1ph 230	1.3	2600
TPD32 EV-.../...-2700-...-E		8700	1ph 230	1.3	2600
TPD32 EV-.../...-2900-...-E		8700	1ph 230	1.3	2600
TPD32 EV-.../...-3300-...-E		9500	1ph 230	1.3	2000

TPD32 EV-FC Drive Rating	PV Heat dissipation [W]	Fans		
		Voltage [V]	Rated current [A]	Air capacity [m3/h]
TPD32-EV-FC-.../...-20-...-A	110	-	-	-
TPD32-EV-FC-.../...-40-...-A	165	-	-	-
TPD32-EV-FC-.../...-70-...-A	233	Int.supply	Int.supply	160
TPD32-EV-FC-.../...-110-...-A	377	Int.supply	Int.supply	160
TPD32-EV-FC-.../...-140-...-A	445	Int.supply	Int.supply	160
TPD32-EV-FC-.../...-185-...-A	522	Int.supply	Int.supply	160
TPD32-EV-FC-.../...-280-...-B	741	Int.supply	Int.supply	320
TPD32-EV-FC-.../...-350-...-B	899	Int.supply	Int.supply	320
TPD32-EV-FC-.../...-420-...-B	998	Int.supply	Int.supply	320
TPD32-EV-FC-.../...-500-...-B	1208	Int.supply	Int.supply	320
TPD32-EV-FC-.../...-650-...-B	1653	Int.supply	Int.supply	680

TPD32 EV-CU Drive Rating	PV Heat dissipation [W]	Fans		
		Voltage [V]	Rated current [A]	Air capacity [m3/h]
TPD32-EV-CU-230/500-THY1-40	303	Int.supply	Int.supply	160
TPD32-EV-CU-230/500-THY2-40	303	Int.supply	Int.supply	160
TPD32-EV-CU-230/500-THY1-70	357	Int.supply	Int.supply	160
TPD32-EV-CU-230/500-THY2-70	357	Int.supply	Int.supply	160
TPD32-EV-CU-575/690-THY1-40	374	Int.supply	Int.supply	160
TPD32-EV-CU-575/690-THY2-40	374	Int.supply	Int.supply	160
TPD32-EV-CU-575/690-THY1-70	428	Int.supply	Int.supply	160
TPD32-EV-CU-575/690-THY2-70	428	Int.supply	Int.supply	160

TPD32 EV-...-12P TPD32 EV-...-12S European Drive Rating	PV Heat dissipation [W]	Fans		
		Voltage [V]	Rated current [A]	Air capacity [m3/h]
TPD32 EV-.../...-1010-...-E	3500	230	0.4	900
TPD32 EV-.../...-1400-...-E	4900	230	0.4	900
TPD32 EV-.../...-1700-...-E	6700	230	0.6	1450
TPD32 EV-.../...-2000-...-E	6800	230	0.6	1450
TPD32 EV-.../...-2400-...-E	8000	230	1.3	2600
TPD32 EV-.../...-2700-...-E	8700	230	1.3	2600
TPD32 EV-.../...-3300-...-E	9500	230	1.3	2000

The 12 pulses DC drives are composed by two identical bridges, the data showed above refers to one bridge only.

I convertitori DC a 12 impulsi sono composti da 2 ponti esterni identici, i dati indicati sopra si riferiscono a un solo ponte.

Les convertisseurs CC à 12 impulsions sont constitués de 2 ponts externes identiques ; les données indiquées ci-dessus se réfèrent à un seul pont.

Die DC-Stromrichter mit 12 Impulsen bestehen aus 2 identischen externen Brücken; die oberhalb angegebenen Daten beziehen sich auf eine einzige Brücke.

Los convertidores CC de 12 impulsos constan de 2 puentes externos idénticos, los datos mostrados anteriormente se refieren a un solo puente.

TPD32 EV - European Drive Rating

Versioni per l'Europa
Version pour l'Europe
Ausführung Europa
Drive para Europa



TPD32-EV...-A



TPD32-EV...-B

Code	Type	Functioning quadrants	UL/cUL approval	Input voltage	Output current
S4TP01	TPD32-EV-500/600-20-2B-A	2 quadrant	✓	3 x 500V	20A
S4TP02	TPD32-EV-500/600-40-2B-A	2 quadrant	✓	3 x 500V	40A
S4TP03	TPD32-EV-500/600-70-2B-A	2 quadrant	✓	3 x 500V	70A
S4TP04	TPD32-EV-500/600-110-2B-A	2 quadrant	✓	3 x 500V	110A
S4TP05	TPD32-EV-500/600-140-2B-A	2 quadrant	✓	3 x 500V	140A
S4TP06	TPD32-EV-500/600-185-2B-A	2 quadrant	✓	3 x 500V	185A
S4TP07	TPD32-EV-500/600-280-2B-B	2 quadrant	✓	3 x 500V	280A
S4TP08	TPD32-EV-500/600-350-2B-B	2 quadrant	✓	3 x 500V	350A
S4TP09	TPD32-EV-500/600-420-2B-B	2 quadrant	✓	3 x 500V	420A
S4TP10	TPD32-EV-500/600-500-2B-B	2 quadrant	✓	3 x 500V	500A
S4TP11	TPD32-EV-500/600-650-2B-B	2 quadrant	✓	3 x 500V	650A
S4TP12	TPD32-EV-500/600-770-2B-C	2 quadrant	✓	3 x 500V	770A
S4TP13	TPD32-EV-500/600-1000-2B-C	2 quadrant	✓	3 x 500V	1000A
S4TP39	TPD32-EV-500/600-1400-2B-D	2 quadrant	✓	3 x 500V	1400A
S4TP40	TPD32-EV-500/600-1600-2B-D	2 quadrant	✓	3 x 500V	1600A
S4TP41	TPD32-EV-500/600-2000-2B-D	2 quadrant	✓	3 x 500V	2000A
S4TP42	TPD32-EV-500/600-2400-2B-D	2 quadrant	✓	3 x 500V	2400A
S4TP14	TPD32-EV-500/600-1200-2B-E	2 quadrant	×	3 x 500V	1200A
S4TP15	TPD32-EV-500/600-1500-2B-E	2 quadrant	×	3 x 500V	1500A
S4TP16	TPD32-EV-500/600-1800-2B-E	2 quadrant	×	3 x 500V	1800A
S4TP17	TPD32-EV-500/600-2000-2B-E	2 quadrant	×	3 x 500V	2000A
S4TP18	TPD32-EV-500/600-2400-2B-E	2 quadrant	×	3 x 500V	2400A
S4TP19	TPD32-EV-500/600-2700-2B-E	2 quadrant	×	3 x 500V	2700A
S4TP20	TPD32-EV-500/600-2900-2B-E	2 quadrant	×	3 x 500V	2900A
S4TP21	TPD32-EV-500/600-3300-2B-E	2 quadrant	×	3 x 500V	3300A
S4TP29	TPD32-EV-575/680-280-2B-B	2 quadrant	✓	3 x 575V	280A
S4TP30	TPD32-EV-575/680-350-2B-B	2 quadrant	✓	3 x 575V	350A
S4TP31	TPD32-EV-575/680-420-2B-B	2 quadrant	✓	3 x 575V	420A
S4TP32	TPD32-EV-575/680-500-2B-B	2 quadrant	✓	3 x 575V	500A
S4TP33	TPD32-EV-575/680-650-2B-B	2 quadrant	✓	3 x 575V	650A
S4TP34	TPD32-EV-575/680-700-2B-C	2 quadrant	✓	3 x 575V	700A
S4TP35	TPD32-EV-575/680-1000-2B-C	2 quadrant	✓	3 x 575V	1000A
S4TP43	TPD32-EV-575/680-1300-2B-D	2 quadrant	✓	3 x 575V	1300A
S4TP44	TPD32-EV-575/680-1600-2B-D	2 quadrant	✓	3 x 575V	1600A
S4TP45	TPD32-EV-575/680-2000-2B-D	2 quadrant	✓	3 x 575V	2000A
S4TP46	TPD32-EV-575/680-2300-2B-D	2 quadrant	✓	3 x 575V	2300A
S4TP36	TPD32-EV-690/810-560-2B-C	2 quadrant	×	3 x 690V	560A
S4TP37	TPD32-EV-690/810-700-2B-C	2 quadrant	×	3 x 690V	700A
S4TP38	TPD32-EV-690/810-900-2B-C	2 quadrant	×	3 x 690V	900A
S4TP47	TPD32-EV-690/810-1300-2B-D	2 quadrant	×	3 x 690V	1300A
S4TP48	TPD32-EV-690/810-1600-2B-D	2 quadrant	×	3 x 690V	1600A
S4TP49	TPD32-EV-690/810-1900-2B-D	2 quadrant	×	3 x 690V	1900A
S4TP50	TPD32-EV-690/810-2100-2B-D	2 quadrant	×	3 x 690V	2100A
S4TP22	TPD32-EV-690/810-1010-2B-E	2 quadrant	×	3 x 690V	1010A
S4TP23	TPD32-EV-690/810-1400-2B-E	2 quadrant	×	3 x 690V	1400A
S4TP24	TPD32-EV-690/810-1700-2B-E	2 quadrant	×	3 x 690V	1700A
S4TP25	TPD32-EV-690/810-2000-2B-E	2 quadrant	×	3 x 690V	2000A
S4TP26	TPD32-EV-690/810-2400-2B-E	2 quadrant	×	3 x 690V	2400A
S4TP27	TPD32-EV-690/810-2700-2B-E	2 quadrant	×	3 x 690V	2700A
S4TP28	TPD32-EV-690/810-3300-2B-E	2 quadrant	×	3 x 690V	3300A



The TPD32-EV-CU control unit already set for the rated current is included as standard with TPD32 EV...-E external bridges.

I Ponti esterni TPD32 EV...-E includono di serie l'unità di controllo TPD32-EV-CU già impostata per la taglia di corrente.

Les ponts extérieurs TPD32 EV...-E sont équipés de série de l'unité de contrôle TPD32-EV-CU déjà configurée pour la grandeur du courant.



Die externen Brücken TPD32 EV...-E umfassen serienmäßig die Steuereinheit TPD32-EV-CU, die bereits für die Stromgröße eingestellt ist.



Los puentes externos TPD32 EV...-E incluyen de serie la unidad de control TPD32-EV-CU ya ajustada para los valores de corriente.

TPD32 EV - European Drive Rating

Versioni per l'Europa
Version pour l'Europe
Ausführung Europa
Drive para Europa



TPD32-EV-...-C



TPD32-EV-...-D

Code	Type	Functioning quadrants	UL/cUL approval	Input voltage	Output current
S4TP61	TPD32-EV-500/520-20-4B-A	4 quadrant	✓	3 x 500V	20A
S4TP62	TPD32-EV-500/520-40-4B-A	4 quadrant	✓	3 x 500V	40A
S4TP63	TPD32-EV-500/520-70-4B-A	4 quadrant	✓	3 x 500V	70A
S4TP64	TPD32-EV-500/520-110-4B-A	4 quadrant	✓	3 x 500V	110A
S4TP65	TPD32-EV-500/520-140-4B-A	4 quadrant	✓	3 x 500V	140A
S4TP66	TPD32-EV-500/520-185-4B-A	4 quadrant	✓	3 x 500V	185A
S4TP67	TPD32-EV-500/520-280-4B-B	4 quadrant	✓	3 x 500V	280A
S4TP68	TPD32-EV-500/520-350-4B-B	4 quadrant	✓	3 x 500V	350A
S4TP69	TPD32-EV-500/520-420-4B-B	4 quadrant	✓	3 x 500V	420A
S4TP70	TPD32-EV-500/520-500-4B-B	4 quadrant	✓	3 x 500V	500A
S4TP71	TPD32-EV-500/520-650-4B-B	4 quadrant	✓	3 x 500V	650A
S4TP72	TPD32-EV-500/520-770-4B-C	4 quadrant	✓	3 x 500V	770A
S4TP73	TPD32-EV-500/520-1050-4B-C	4 quadrant	✓	3 x 500V	1050A
S4TP97	TPD32-EV-500/520-1400-4B-D	4 quadrant	✓	3 x 500V	1400A
S4TP98	TPD32-EV-500/520-1600-4B-D	4 quadrant	✓	3 x 500V	1600A
S4TP99	TPD32-EV-500/520-2000-4B-D	4 quadrant	✓	3 x 500V	2000A
S4TP100	TPD32-EV-500/520-2400-4B-D	4 quadrant	✓	3 x 500V	2400A
S4TP74	TPD32-EV-500/520-1500-4B-E	4 quadrant	×	3 x 500V	1500A
S4TP75	TPD32-EV-500/520-1700-4B-E	4 quadrant	×	3 x 500V	1700A
S4TP76	TPD32-EV-500/520-2000-4B-E	4 quadrant	×	3 x 500V	2000A
S4TP77	TPD32-EV-500/520-2400-4B-E	4 quadrant	×	3 x 500V	2400A
S4TP78	TPD32-EV-500/520-2700-4B-E	4 quadrant	×	3 x 500V	2700A
S4TP79	TPD32-EV-500/520-3300-4B-E	4 quadrant	×	3 x 500V	3300A
S4TP87	TPD32-EV-575/600-280-4B-B	4 quadrant	✓	3 x 575V	280A
S4TP88	TPD32-EV-575/600-350-4B-B	4 quadrant	✓	3 x 575V	350A
S4TP89	TPD32-EV-575/600-420-4B-B	4 quadrant	✓	3 x 575V	420A
S4TP90	TPD32-EV-575/600-500-4B-B	4 quadrant	✓	3 x 575V	500A
S4TP91	TPD32-EV-575/600-650-4B-B	4 quadrant	✓	3 x 575V	650A
S4TP92	TPD32-EV-575/600-700-4B-C	4 quadrant	✓	3 x 575V	700A
S4TP93	TPD32-EV-575/600-1050-4B-C	4 quadrant	✓	3 x 575V	1050A
S4TP101	TPD32-EV-575/600-1300-4B-D	4 quadrant	✓	3 x 575V	1300A
S4TP102	TPD32-EV-575/600-1600-4B-D	4 quadrant	✓	3 x 575V	1600A
S4TP103	TPD32-EV-575/600-2000-4B-D	4 quadrant	✓	3 x 575V	2000A
S4TP104	TPD32-EV-575/600-2300-4B-D	4 quadrant	✓	3 x 575V	2300A
S4TP94	TPD32-EV-690/720-560-4B-C	4 quadrant	×	3 x 690V	560A
S4TP95	TPD32-EV-690/720-700-4B-C	4 quadrant	×	3 x 690V	700A
S4TP96	TPD32-EV-690/720-900-4B-C	4 quadrant	×	3 x 690V	900A
S4TP105	TPD32-EV-690/720-1300-4B-D	4 quadrant	×	3 x 690V	1300A
S4TP106	TPD32-EV-690/720-1600-4B-D	4 quadrant	×	3 x 690V	1600A
S4TP107	TPD32-EV-690/720-1900-4B-D	4 quadrant	×	3 x 690V	1900A
S4TP108	TPD32-EV-690/720-2100-4B-D	4 quadrant	×	3 x 690V	2100A
S4TP80	TPD32-EV-690/720-1010-4B-E	4 quadrant	×	3 x 690V	1010A
S4TP81	TPD32-EV-690/720-1400-4B-E	4 quadrant	×	3 x 690V	1400A
S4TP82	TPD32-EV-690/720-1700-4B-E	4 quadrant	×	3 x 690V	1700A
S4TP83	TPD32-EV-690/720-2000-4B-E	4 quadrant	×	3 x 690V	2000A
S4TP84	TPD32-EV-690/720-2400-4B-E	4 quadrant	×	3 x 690V	2400A
S4TP85	TPD32-EV-690/720-2700-4B-E	4 quadrant	×	3 x 690V	2700A
S4TP86	TPD32-EV-690/720-3300-4B-E	4 quadrant	×	3 x 690V	3300A



The TPD32-EV-CU control unit already set for the rated current is included as standard with TPD32 EV-...-E external bridges.

I Ponti esterni TPD32 EV-...-E includono di serie l'unità di controllo TPD32-EV-CU già impostata per la taglia di corrente.

Les ponts extérieurs TPD32 EV-...-E sont équipés de série de l'unité de contrôle TPD32-EV-CU déjà configurée pour la grandeur du courant.



Die externen Brücken TPD32 EV-...-E umfassen serienmäßig die Steuereinheit TPD32-EV-CU, die bereits für die Stromgröße eingestellt ist.



Las puentes externos TPD32 EV-...-E incluyen de serie la unidad de control TPD32-EV-CU ya ajustada para los valores de corriente.

TPD32 EV-...-2B • American Drive Rating, UL compliant

Versioni per America, conformi alla normativa UL
Version pour l'Amerique du nord, conforme à la norme UL
Ausführung Amerika, UL-konform
Drive para América, cumple con la normativa UL

Code	Type	Functioning quadrants	UL/cUL approval	Input voltage	Output current
S4TN01	TPD32-EV-500/600-17-2B-A-NA	2 quadrant	✓	3 x 500V	17A
S4TN02	TPD32-EV-500/600-35-2B-A-NA	2 quadrant	✓	3 x 500V	35A
S4TN03	TPD32-EV-500/600-56-2B-A-NA	2 quadrant	✓	3 x 500V	56A
S4TN04	TPD32-EV-500/600-88-2B-A-NA	2 quadrant	✓	3 x 500V	88A
S4TN05	TPD32-EV-500/600-112-2B-A-NA	2 quadrant	✓	3 x 500V	112A
S4TN06	TPD32-EV-500/600-148-2B-A-NA	2 quadrant	✓	3 x 500V	148A
S4TN07	TPD32-EV-500/600-224-2B-B-NA	2 quadrant	✓	3 x 500V	224A
S4TN08	TPD32-EV-500/600-280-2B-B-NA	2 quadrant	✓	3 x 500V	280A
S4TN09	TPD32-EV-500/600-336-2B-B-NA	2 quadrant	✓	3 x 500V	336A
S4TN10	TPD32-EV-500/600-400-2B-B-NA	2 quadrant	✓	3 x 500V	400A
S4TN11	TPD32-EV-500/600-450-2B-B-NA	2 quadrant	✓	3 x 500V	450A
S4TN12	TPD32-EV-500/600-560-2B-C-NA	2 quadrant	✓	3 x 500V	560A
S4TN13	TPD32-EV-500/600-800-2B-C-NA	2 quadrant	✓	3 x 500V	800A
S4TN24	TPD32-EV-500/600-1000-2B-D-NA	2 quadrant	✓	3 x 500V	1000A
S4TN25	TPD32-EV-500/600-1200-2B-D-NA	2 quadrant	✓	3 x 500V	1200A
S4TN26	TPD32-EV-500/600-1500-2B-D-NA	2 quadrant	✓	3 x 500V	1500A
S4TN27	TPD32-EV-500/600-1850-2B-D-NA	2 quadrant	✓	3 x 500V	1850A
S4TN14	TPD32-EV-575/680-224-2B-B-NA	2 quadrant	✓	3 x 575V	224A
S4TN15	TPD32-EV-575/680-280-2B-B-NA	2 quadrant	✓	3 x 575V	280A
S4TN16	TPD32-EV-575/680-336-2B-B-NA	2 quadrant	✓	3 x 575V	336A
S4TN17	TPD32-EV-575/680-400-2B-B-NA	2 quadrant	✓	3 x 575V	400A
S4TN18	TPD32-EV-575/680-450-2B-B-NA	2 quadrant	✓	3 x 575V	450A
S4TN19	TPD32-EV-575/680-490-2B-C-NA	2 quadrant	✓	3 x 575V	490A
S4TN20	TPD32-EV-575/680-750-2B-C-NA	2 quadrant	✓	3 x 575V	750A
S4TN28	TPD32-EV-575/680-980-2B-D-NA	2 quadrant	✓	3 x 575V	980A
S4TN29	TPD32-EV-575/680-1200-2B-D-NA	2 quadrant	✓	3 x 575V	1200A
S4TN30	TPD32-EV-575/680-1500-2B-D-NA	2 quadrant	✓	3 x 575V	1500A
S4TN31	TPD32-EV-575/680-1800-2B-D-NA	2 quadrant	✓	3 x 575V	1800A



The TPD32-EV-CU control unit already set for the rated current is included as standard with TPD32 EV-...-E external bridges.



I Ponti esterni TPD32 EV-...-E includono di serie l'unità di controllo TPD32-EV-CU già impostata per la taglia di corrente.



Les ponts extérieurs TPD32 EV-...-E sont équipés de série de l'unité de contrôle TPD32-EV-CU déjà configurée pour la grandeur du courant.



Die externen Brücken TPD32 EV-...-E umfassen serienmäßig die Steuereinheit TPD32-EV-CU, die bereits für die Stromgröße eingestellt ist.



Los puentes externos TPD32 EV-...-E incluyen de serie la unidad de control TPD32-EV-CU ya ajustada para los valores de corriente.

نماینده رسمی جفران ایتالیا در ایران

TPD32 EV-...-4B • American Drive Rating, UL compliant

Versioni per America, conformi alla normativa UL
Version pour l'Amérique du nord, conforme à la norme UL
Ausführung Amerika, UL-konform
Drive para América, cumple con la normativa UL

Code	Type	Functioning quadrants	UL/cUL approval	Input voltage	Output current
S4TN61	TPD32-EV-500/520-17-4B-NA	4 quadrant	✓	3 x 500V	17A
S4TN62	TPD32-EV-500/520-35-4B-NA	4 quadrant	✓	3 x 500V	35A
S4TN63	TPD32-EV-500/520-56-4B-NA	4 quadrant	✓	3 x 500V	56A
S4TN64	TPD32-EV-500/520-88-4B-NA	4 quadrant	✓	3 x 500V	88A
S4TN65	TPD32-EV-500/520-112-4B-NA	4 quadrant	✓	3 x 500V	112A
S4TN66	TPD32-EV-500/520-148-4B-NA	4 quadrant	✓	3 x 500V	148A
S4TN67	TPD32-EV-500/520-224-4B-B-NA	4 quadrant	✓	3 x 500V	224A
S4TN68	TPD32-EV-500/520-280-4B-B-NA	4 quadrant	✓	3 x 500V	280A
S4TN69	TPD32-EV-500/520-336-4B-B-NA	4 quadrant	✓	3 x 500V	336A
S4TN70	TPD32-EV-500/520-400-4B-B-NA	4 quadrant	✓	3 x 500V	400A
S4TN71	TPD32-EV-500/520-450-4B-B-NA	4 quadrant	✓	3 x 500V	450A
S4TN72	TPD32-EV-500/520-560-4B-C-NA	4 quadrant	✓	3 x 500V	560A
S4TN73	TPD32-EV-500/520-850-4B-C-NA	4 quadrant	✓	3 x 500V	850A
S4TN84	TPD32-EV-500/520-1000-4B-D-NA	4 quadrant	✓	3 x 500V	1000A
S4TN85	TPD32-EV-500/520-1200-4B-D-NA	4 quadrant	✓	3 x 500V	1200A
S4TN86	TPD32-EV-500/520-1500-4B-D-NA	4 quadrant	✓	3 x 500V	1500A
S4TN87	TPD32-EV-500/520-1850-4B-D-NA	4 quadrant	✓	3 x 500V	1850A
S4TN74	TPD32-EV-575/600-224-4B-B-NA	4 quadrant	✓	3 x 575V	224A
S4TN75	TPD32-EV-575/600-280-4B-B-NA	4 quadrant	✓	3 x 575V	280A
S4TN76	TPD32-EV-575/600-336-4B-B-NA	4 quadrant	✓	3 x 575V	336A
S4TN77	TPD32-EV-575/600-400-4B-B-NA	4 quadrant	✓	3 x 575V	400A
S4TN78	TPD32-EV-575/600-450-4B-B-NA	4 quadrant	✓	3 x 575V	450A
S4TN79	TPD32-EV-575/600-490-4B-C-NA	4 quadrant	✓	3 x 575V	490A
S4TN80	TPD32-EV-575/600-750-4B-C-NA	4 quadrant	✓	3 x 575V	750A
S4TN88	TPD32-EV-575/600-980-4B-D-NA	4 quadrant	✓	3 x 575V	980A
S4TN89	TPD32-EV-575/600-1200-4B-D-NA	4 quadrant	✓	3 x 575V	1200A
S4TN90	TPD32-EV-575/600-1500-4B-D-NA	4 quadrant	✓	3 x 575V	1500A
S4TN91	TPD32-EV-575/600-1800-4B-D-NA	4 quadrant	✓	3 x 575V	1800A



The TPD32-EV-CU control unit already set for the rated current is included as standard with TPD32 EV-...-E external bridges.



I Ponti esterni TPD32 EV-...-E includono di serie l'unità di controllo TPD32-EV-CU già impostata per la taglia di corrente.



Les ponts extérieurs TPD32 EV-...-E sont équipés de série de l'unité de contrôle TPD32-EV-CU déjà configurée pour la grandeur du courant.



Die externen Brücken TPD32 EV-...-E umfassen serienmäßig die Steuereinheit TPD32-EV-CU, die bereits für die Stromgröße eingestellt ist.



Los puentes externos TPD32 EV-...-E incluyen de serie la unidad de control TPD32-EV-CU ya ajustada para los valores de corriente.

نماینده رسمی جفران ایتالیا در ایران

TPD32 EV-FC-... • Special versions for inductive loads, NOT UL compliant





Versioni speciali per carichi induttivi
 Versions spéciales pour charges
 inductives
 Spezialausführungen für induktive
 Lasten
 Versiones especiales para cargas
 inductivas

Code	Type	Functioning quadrants	UL/cUL approval	Input voltage	Output current
S4TF01	TPD32-EV-FC-500/600-20-2B-A	2 quadrant	✓	3 x 500V	20A
S4TF02	TPD32-EV-FC-500/600-40-2B-A	2 quadrant	✓	3 x 500V	40A
S4TF03	TPD32-EV-FC-500/600-70-2B-A	2 quadrant	✓	3 x 500V	70A
S4TF04	TPD32-EV-FC-500/600-110-2B-A	2 quadrant	✓	3 x 500V	110A
S4TF05	TPD32-EV-FC-500/600-140-2B-A	2 quadrant	✓	3 x 500V	140A
S4TF06	TPD32-EV-FC-500/600-185-2B-A	2 quadrant	✓	3 x 500V	185A
S4TF07	TPD32-EV-FC-500/600-280-2B-B	2 quadrant	✓	3 x 500V	280A
S4TF08	TPD32-EV-FC-500/600-350-2B-B	2 quadrant	✓	3 x 500V	350A
S4TF09	TPD32-EV-FC-500/600-420-2B-B	2 quadrant	✓	3 x 500V	420A
S4TF10	TPD32-EV-FC-500/600-500-2B-B	2 quadrant	✓	3 x 500V	500A
S4TF11	TPD32-EV-FC-500/600-650-2B-B	2 quadrant	✓	3 x 500V	650A
S4TF21	TPD32-EV-FC-500/520-20-4B-A	4 quadrant	✓	3 x 500V	20A
S4TF22	TPD32-EV-FC-500/520-40-4B-A	4 quadrant	✓	3 x 500V	40A
S4TF23	TPD32-EV-FC-500/520-70-4B-A	4 quadrant	✓	3 x 500V	70A
S4TF24	TPD32-EV-FC-500/520-110-4B-A	4 quadrant	✓	3 x 500V	110A
S4TF25	TPD32-EV-FC-500/520-140-4B-A	4 quadrant	✓	3 x 500V	140A
S4TF26	TPD32-EV-FC-500/520-185-4B-A	4 quadrant	✓	3 x 500V	185A
S4TF27	TPD32-EV-FC-500/520-280-4B-B	4 quadrant	✓	3 x 500V	280A
S4TF28	TPD32-EV-FC-500/520-350-4B-B	4 quadrant	✓	3 x 500V	350A
S4TF29	TPD32-EV-FC-500/520-420-4B-B	4 quadrant	✓	3 x 500V	420A
S4TF30	TPD32-EV-FC-500/520-500-4B-B	4 quadrant	✓	3 x 500V	500A
S4TF31	TPD32-EV-FC-500/520-650-4B-B	4 quadrant	✓	3 x 500V	650A
S4TF21M	TPD32-EV-FC-200/210-20-4B-A	4 quadrant	✓	3 x 220V	20A
S4TF22M	TPD32-EV-FC-200/210-40-4B-A	4 quadrant	✓	3 x 220V	40A
S4TF23M	TPD32-EV-FC-200/210-70-4B-A	4 quadrant	✓	3 x 220V	70A
S4TF24M	TPD32-EV-FC-200/210-110-4B-A	4 quadrant	✓	3 x 220V	110A
S4TF25M	TPD32-EV-FC-200/210-140-4B-A	4 quadrant	✓	3 x 220V	140A
S4TF26M	TPD32-EV-FC-200/210-185-4B-A	4 quadrant	✓	3 x 220V	185A
S4TF27M	TPD32-EV-FC-200/210-280-4B-B	4 quadrant	✓	3 x 220V	280A
S4TF28M	TPD32-EV-FC-200/210-350-4B-B	4 quadrant	✓	3 x 220V	350A
S4TF29M	TPD32-EV-FC-200/210-420-4B-B	4 quadrant	✓	3 x 220V	420A
S4TF30M	TPD32-EV-FC-200/210-500-4B-B	4 quadrant	✓	3 x 220V	500A
S4TF31M	TPD32-EV-FC-200/210-650-4B-B	4 quadrant	✓	3 x 220V	650A

TPD32 EV-CU... • Control Unit for External bridge, UL compliant

Unità di controllo per ponti esterni
 Unité de contrôle des ponts extérieurs
 Steuereinheit Externe Brücken
 Unidad de control puentes externos

Code	Type	Functioning quadrants	UL/cUL approval	Input voltage	Field Output current
S4CU01	TPD32-EV-CU-230/500-THY1-40	2B/4B	✓	3 x 230/400/500 Vac	40A
S4CU02	TPD32-EV-CU-230/500-THY2-40	2B/4B	✓	3 x 230/400/500 Vac	40A
S4CU03	TPD32-EV-CU-230/500-THY1-70	2B/4B	✓	3 x 230/400/500 Vac	70A
S4CU04	TPD32-EV-CU-230/500-THY2-70	2B/4B	✓	3 x 230/400/500 Vac	70A
S4CU05	TPD32-EV-CU-575/690-THY1-40	2B/4B	✓	3 x 575/690 Vac	40A
S4CU06	TPD32-EV-CU-575/690-THY2-40	2B/4B	✓	3 x 575/690 Vac	40A
S4CU07	TPD32-EV-CU-575/690-THY1-70	2B/4B	✓	3 x 575/690 Vac	70A
S4CU08	TPD32-EV-CU-575/690-THY2-70	2B/4B	✓	3 x 575/690 Vac	70A

-  The output current for these control units, which are supplied separately with no external bridge, must be set. For connection cables see section Accessories in Appendix.
-  Per queste Unità di controllo, fornite singolarmente senza ponte esterno, è necessario impostare la corrente di uscita. Per i cavi di collegamento vedere sezione Accessori in Appendice.
-  Pour ces unités de contrôle, fournies séparément sans pont extérieur, le courant de sortie doit être configuré. Pour les câbles de branchement, se reporter à la section Accessoires en appendice.
-  Für diese Steuereinheiten, die einzeln und ohne externe Brücke geliefert werden, muss der Ausgangsstrom eingestellt werden. Für die Anschlusskabel siehe Abschnitt Zubehör im Anhang.
-  Para estas unidades de control, entregadas individualmente sin puente externo, es necesario ajustar la corriente de salida. Para los cables de conexión, consulte la sección Accesorios en el Apéndice.

TPD32 EV-...-12P • 12 pulses DC drives , NOT UL compliant

Convertitori DC 12 impulsi
configurazione Parallelo
Convertisseur CC 12 impulsions
configuration en parallèle
DC Stromrichter 12 Impulse Parallel-
Konfiguration
Convertidores CC de 12 impulsos,
configuración en paralelo

Code	Type	Functioning quadrants	UL/cUL approval	Input voltage	Field current	Total Output current
On request	TPD32-EV-690/810-1010-2B-E-12P	2B	×	3 x 690V	40A	2000A
"	TPD32-EV-690/810-1400-2B-E-12P	2B	×	3 x 690V	40A	2800A
"	TPD32-EV-690/810-1700-2B-E-12P	2B	×	3 x 690V	40A	3400A
"	TPD32-EV-690/810-2000-2B-E-12P	2B	×	3 x 690V	40A	4000A
"	TPD32-EV-690/810-2400-2B-E-12P	2B	×	3 x 690V	70A	4800A
"	TPD32-EV-690/810-2700-2B-E-12P	2B	×	3 x 690V	70A	5400A
"	TPD32-EV-690/810-3300-2B-E-12P	2B	×	3 x 690V	70A	6600A
"	TPD32-EV-690/720-1010-4B-E-12P	4B	×	3 x 690V	40A	2000A
"	TPD32-EV-690/720-1400-4B-E-12P	4B	×	3 x 690V	40A	2800A
"	TPD32-EV-690/720-1700-4B-E-12P	4B	×	3 x 690V	40A	3400A
"	TPD32-EV-690/720-2000-4B-E-12P	4B	×	3 x 690V	40A	4000A
"	TPD32-EV-690/720-2400-4B-E-12P	4B	×	3 x 690V	70A	4800A
"	TPD32-EV-690/720-2700-4B-E-12P	4B	×	3 x 690V	70A	5400A
"	TPD32-EV-690/720-3300-4B-E-12P	4B	×	3 x 690V	70A	6600A
"	TPD32-EV-1000/.....-E-12P	4B	×	3 x 1000V		

TPD32 EV-...-12S • 12 pulses DC drives , NOT UL compliant





Convertitori DC 12 impulsi
configurazione Serie
Convertisseur CC 12 impulsions
configuration en Série
DC Stromrichter 12 Impulse Serie-
Konfiguration
Convertidores CC de 12 impulsos,
configuración en Serie





Code	Type	Functioning quadrants	UL/cUL approval	Input voltage	Field current	Total Output current
On request	TPD32-EV-350/410-1010-2B-E-12S	2B	×	3 x 350V	40A	1000A
"	TPD32-EV-350/410-1400-2B-E-12S	2B	×	3 x 350V	40A	1400A
"	TPD32-EV-350/410-1700-2B-E-12S	2B	×	3 x 350V	40A	1700A
"	TPD32-EV-350/410-2000-2B-E-12S	2B	×	3 x 350V	40A	2000A
"	TPD32-EV-350/410-2400-2B-E-12S	2B	×	3 x 350V	70A	2400A
"	TPD32-EV-350/410-2700-2B-E-12S	2B	×	3 x 350V	70A	2700A
"	TPD32-EV-350/410-3300-2B-E-12S	2B	×	3 x 350V	70A	3300A
"	TPD32-EV-350/360-1010-4B-E-12S	4B	×	3 x 350V	40A	1000A
"	TPD32-EV-350/360-1400-4B-E-12S	4B	×	3 x 350V	40A	1400A
"	TPD32-EV-350/360-1700-4B-E-12S	4B	×	3 x 350V	40A	1700A
"	TPD32-EV-350/360-2000-4B-E-12S	4B	×	3 x 350V	40A	2000A
"	TPD32-EV-350/360-2400-4B-E-12S	4B	×	3 x 350V	70A	2400A
"	TPD32-EV-350/360-2700-4B-E-12S	4B	×	3 x 350V	70A	2700A
"	TPD32-EV-350/360-3300-4B-E-12S	4B	×	3 x 350V	70A	3300A
"	TPD32-EV-500/.....-E-12S	4B	×	3 x 500V		

Power side fuses

Fusibili dalla parte di potenza
Fusibles de la partie de puissance
Sicherungen am Leistungsteil
Fusibles de la parte de potencia

Note: TPD32-EV-FC: see page 52

-  The fuse technical data, such as dimensions, weights, dissipated power, heat etc. can be found in the relevant fuse manufacturer catalogues (Z.= Jean Muller; FWP., 170M.= Bussmann; A.=Gould Shawmut).
-  I dati tecnici dei fusibili, come ad esempio dimensioni, peso, dissipazione, calore, ecc. sono disponibili nei relativi cataloghi dei costruttori fusibili (Z.= Jean Muller; FWP., 170M.= Bussmann; A.=Gould Shawmut).
-  Les caractéristiques techniques des fusibles telles que, les dimensions, le poids, la dissipation, etc., sont indiquées dans les catalogues correspondants du fabricant de fusibles (Z.= Jean Muller; FWP., 170M.= Bussmann; A.=Gould Shawmut).
-  Die technischen Daten der Sicherungen, wie beispielsweise Abmessungen, Gewicht, Verlustleistung, Wärme, usw. sind den entsprechenden Katalogen der Sicherungshersteller zu entnehmen (Z.= Jean Muller; FWP., 170M.= Bussmann; A.=Gould Shawmut).
-  Los datos técnicos de los fusibles, tales como dimensiones, peso, energía disipada, calor, etc. se pueden encontrar en los catálogos de fabricantes de fusibles (Z.= Jean Muller; FWP., 170M.= Bussmann; A.=Gould Shawmut).

-  On TPD32 EV...-C, TPD32 EV...-D and TPD32 EV...-E sizes the super fast fuses for the AC mains input are integrated in the device (Fc).
The FA and FB fuses are externally mounted
-  Nelle taglie TPD32 EV...-C, TPD32 EV...-D e TPD32 EV...-E i fusibili extrarapidi di rete sono già presenti all'interno dell'apparecchio (Fc).
I fusibili FA e FB sono montati esternamente.
-  Pour les grandeurs TPD32 EV...-C, TPD32 EV...-D et TPD32 EV...-E les fusibles extra-rapides de réseau sont déjà installés dans l'appareil (Fc).
Les fusibles FA et FB sont montés à l'extérieur du variateur.
-  Für die Größen TPD32 EV...-C, TPD32 EV...-D und TPD32 EV...-E sind die superflinken Sicherungen an den Eingangsseite bereits im Geräteinneren vorhanden (C).
Die Sicherungen FA und FB werden extern angeordnet.
-  En los tamaños TPD32 EV...-C, TPD32 EV...-D y TPD32 EV...-E los fusibles extrarrápidos de red se encuentran ya en el interior del aparato (Fc).
Los fusibles FA e FB van montados externamente.

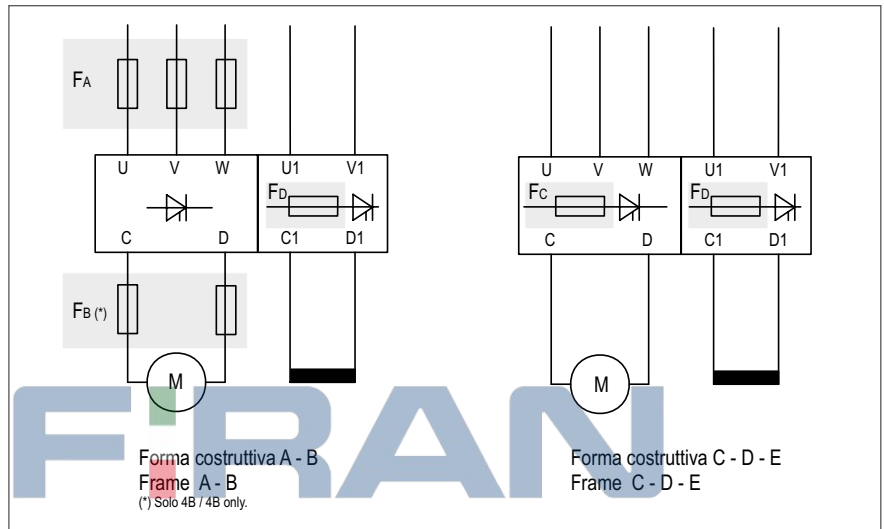

نماینده رسمی جفران ایتالیا در ایران

FA - Input Side External Fuses

Fa · Fusibili esterni lato ingresso
Fa · Fusibles réseau extérieures
Fa · Externe Sicherungen Eingangsseite
Fa · Fusibles externos del lado de alimentación de red

European Drive Rating	Q.ty no.	Europe		America	
		Fuse type	Code	Fuse type	Code
TPD32-EV-.../...-20...-A	3	Z14gR20	F4M07	A70P25	S7G51
TPD32-EV-.../...-40...-A	3	Z22gR50	F4M15	A70P40	S7G52
TPD32-EV-.../...-70...-A	3	Z22gR63	F4M17	A70P80	S7G54
TPD32-EV-.../...-110...-A	3	S00C+/üf1/80/100A/660V	F4EAG	A70P100	S7G55
TPD32-EV-.../...-140...-A	3	S00C+/üf1/80/125A/660V	F4EAJ	A70P150	S7G56
TPD32-EV-.../...-185...-A	3	S00üf1/80/200A/660V	F4G23	A70P175	S7G57
TPD32-EV-.../...-280...-B	3	S1üf1/110/250A/660V	F4G28	A70P300	S7G60
TPD32-EV-.../...-350...-B	3	S1üf1/110/315A/660V	F4G30	A70P350	S7G61
TPD32-EV-.../...-420...-B	3	S2üf1/110/400A/660V	F4G34	A70P400	S7G62
TPD32-EV-.../...-500...-B	3	S2üf1/110/500A/660V	F4E30	A70P500	S7G63
TPD32-EV-.../...-650...-B	3	S2üf1/110/630A/660V	F4E31	A70P600	S7G65

American Drive Rating	Q.ty no.	America	
		Fuse type	Code
TPD32 EV-...-.../...-17...-A-NA	3	A70P25	S7G51
TPD32 EV-...-.../...-35...-A-NA	3	A70P40	S7G52
TPD32 EV-...-.../...-56...-A-NA	3	A70P80	S7G54
TPD32 EV-...-.../...-88...-A-NA	3	A70P100	S7G55
TPD32 EV-...-.../...-112...-A-NA	3	A70P150	S7G56
TPD32 EV-...-.../...-148...-A-NA	3	A70P175	S7G57
TPD32 EV-...-.../...-224...-B-NA	3	A70P300	S7G60
TPD32 EV-...-.../...-280...-B-NA	3	A70P350	S7G61
TPD32 EV-...-.../...-336...-B-NA	3	A70P400	S7G62
TPD32 EV-...-.../...-400...-B-NA	3	A70P500	S7G63
TPD32 EV-...-.../...-450...-B-NA	3	A70P600	S7G65





FB · External fuses for the armature circuit

FB · Fusibili esterni per il circuito di armatura
 FB · Fusibles extérieurs pour le circuit d'armature
 FB · Externe Sicherungen für den Ankerkreis
 FB · Fusibles externos para el circuito de potencia

European Drive Rating	Q.ty no.	Europe		America	
		Fuse type	Code	Fuse type	Code
TPD32-EV-500/...-20-4B-A	2	Z14gR20	F4M07	A70P25	S7G51
TPD32-EV-500/...-40-4B-A	2	Z22gR63	F4M17	A70P80	S7G54
TPD32-EV-500/...-70-4B-A	2	S00C+/üf1/80/100A/660V	F4EAG	A70P100	S7G55
TPD32-EV-500/...-110-4B-A	2	S00C+/üf1/80/125A/660V	F4EAJ	A70P150	S7G56
TPD32-EV-500/...-140-4B-A	2	S00C+/üf1/80/160A/660V	F4EAL	A70P175	S7G57
TPD32-EV-500/...-185-4B-A	2	S00üf1/80/200A/660V	F4G23	A70P200	S7G58
TPD32-EV-500/...-280-4B-B	2	S1üf1/110/315A/660V	F4G30	A70P350	S7G61
TPD32-EV-500/...-350-4B-B	2	S2üf1/110/400A/660V	F4G34	A70P400	S7G62
TPD32-EV-500/...-420-4B-B	2	S2üf1/110/500A/660V	F4E30	A70P500	S7G63
TPD32-EV-500/...-500-4B-B	2	S2üf1/110/630A/660V	F4E31	A70P600	S7G65
TPD32-EV-500/...-650-4B-B	2	S2üf1/110/710A/660V	F4G85	A70P700	S7G67
TPD32-EV-575/...-280-4B-B	2	S2üf01/110/315A/1000V	-	A100P350-4	-
TPD32-EV-575/...-350-4B-B	2	S2üf01/110/400A/1000V		A100P400-4	
TPD32-EV-575/...-420-4B-B	2	S2üf01/110/500A/1000V		A100P500-4	
TPD32-EV-575/...-500-4B-B	2	S3üf01/110/630A/1000V	S85C4	A100P600-4	
TPD32-EV-575/...-650-4B-B	2	S3üf01/110/710A/1000V	S85C5	A100P800-4	

GEFIRAN

نماینده رسمی جفران ایتالیا در ایران

 Necessary only for the four quadrant functioning.
 Necessari solo per funzionamento tetraquadrante.
 Nécessaires seulement pour fonctionnement 4-quadrants.
 Notwendig nur bei Vierquadranten Betrieb.
 Necesarios sólo para funcionamiento tetracuadrante.

American Drive Rating	Q.ty no.	America	
		Fuse type	Code
TPD32 EV-500/...-17-4B-A-NA	2	A70P25	S7G51
TPD32 EV-500/...-35-4B-A-NA	2	A70P40	S7G52
TPD32 EV-500/...-56-4B-A-NA	2	A70P80	S7G54
TPD32 EV-500/...-88-4B-A-NA	2	A70P100	S7G55
TPD32 EV-500/...-112-4B-A-NA	2	A70P150	S7G56
TPD32 EV-500/...-148-4B-A-NA	2	A70P175	S7G57
TPD32 EV-500/...-224-4B-B-NA	2	A70P300	S7G60
TPD32 EV-500/...-280-4B-B-NA	2	A70P350	S7G61
TPD32 EV-500/...-336-4B-B-NA	2	A70P400	S7G62
TPD32 EV-500/...-400-4B-B-NA	2	A70P500	S7G63
TPD32 EV-500/...-450-4B-B-NA	2	A70P600	S7G65
TPD32 EV-575/...-224-4B-B-NA	2	A100P300-4	
TPD32 EV-575/...-280-4B-B-NA	2	A100P350-4	
TPD32 EV-575/...-336-4B-B-NA	2	A100P400-4	
TPD32 EV-575/...-400-4B-B-NA	2	A100P500-4	
TPD32 EV-575/...-450-4B-B-NA	2	A100P600-4	

Fc · Input Side Internal fuses

(TPD32 EV-...-C, TPD32 EV-...-D and TPD32 EV-...-E)

Fc · Fusibili interni lato ingresso
 Fc · Fusibles internes réseau
 Fc · Interne Sicherungen Eingangsseite
 Fc · Fusibles internos del lado de alimentación de red



These fuses are internally mounted and are provided on the delivery (TPD32 EV-...-C, TPD32 EV-...-D series and TPD32 EV-...-E).

For sizes TPD32-EV-...-12P and TPD32-EV-...-12S reference should be made to the corresponding voltage and current sizes.



Questi fusibili sono montati internamente e sono parte integrante della fornitura (serie TPD32 EV-...-C, TPD32 EV-...-D e TPD32 EV-...-E).

Per le taglie TPD32-EV-...-12P e TPD32-EV-...-12S fare riferimento alle corrispondenti taglie in tensione e corrente.



Ces fusibles sont montés en interne et font partie intégrante de la fourniture (séries TPD32 EV-...-C, TPD32 EV-...-D et TPD32 EV-...-E).

Pour les grandeurs TPD32-EV-...-12P e TPD32-EV-...-12S, faire référence aux grandeurs correspondantes en tension et courant.



Diese Sicherungen sind intern eingebaut und sind wesentlicher Bestandteil der Lieferung (Serie TPD32 EV-...-C, TPD32 EV-...-D und TPD32 EV-...-E).

Für die Baugrößen TPD32-EV-...-12P und TPD32-EV-...-12S siehe die entsprechenden Spannungs- und Stromgrößen.



Estos fusibles están montados internamente y forman parte integrante del suministro (serie TPD32 EV-...-C, TPD32 EV-...-D e TPD32 EV-...-E).

Para los tamaños TPD32-EV-...-12P y TPD32-EV-...-12S, consulte los tamaños correspondientes de tensión y corriente.

European Drive Rating	Q.ty no.	Europe Fuse type	Code	America Fuse type	Code
TPD32 EV-500/600-770-2B-C	3	G2MUF02 800A 660V	S826B	170M 5464 800A 660V	S7792
TPD32 EV-500/600-1000-2B-C	3	170M 5466 1000A 660V	S827B	170M 5466 1000A 660V	S827B
TPD32-EV-500/600-1400-2B-D	6	170M 6263 900A 690V	S86C1	170M 6263 900A 690V	S86C1
TPD32-EV-500/600-1600-2B-D	6	170M 6265 1100A 690V	S86C2	170M 6265 1100A 690V	S86C2
TPD32-EV-500/600-2000-2B-D	6	170M 6267 1400A 690V	S85C2	170M 6267 1400A 690V	S85C2
TPD32-EV-500/600-2400-2B-D	12	170M 6263 900A 690V	S86C1	170M 6263 900A 690V	S86C1
TPD32-EV-500/600-1200-2B-E	6	170M 5464 800A 660V	S7792	170M 5464 800A 660V	S7792
TPD32 EV-500/600-1500-2B-E	6	170M 6464 1000A 660V	S7799	170M 6464 1000A 660V	S7799
TPD32 EV-500/600-1800-2B-E	6	170M 6466 1250A 660V	S7802	170M 6466 1250A 660V	S7802
TPD32 EV-500/600-2000-2B-E	6	170M 6466 1250A 660V	S7802	170M 6466 1250A 660V	S7802
TPD32 EV-500/600-2400-2B-E	6	170M 6467 1400A 660V	S7803	170M 6467 1400A 660V	S7803
TPD32 EV-500/600-2700-2B-E	12	170M 6462 800A 660V	S7797	170M 6462 800A 660V	S7797
TPD32 EV-500/600-2900-2B-E	12	170M 6463 900A 660V	S7798	170M 6463 900A 660V	S7798
TPD32 EV-500/600-3300-2B-E	12	170M 6466 1250A 660V	S7802	170M 6466 1250A 660V	S7802
TPD32-EV-575/680-700-2B-C	3	170M 5463 700A 690V	S7791	170M 5463 700A 690V	S7791
TPD32-EV-575/680-1000-2B-C	3	170M 5466 1000A 690V	S827B	170M 5466 1000A 690V	S827B
TPD32-EV-575/680-1300-2B-D	6	170M 6263 900A 690V	S86C1	170M 6263 900A 690V	S86C1
TPD32-EV-575/680-1600-2B-D	6	170M 6265 1100A 690V	S86C2	170M 6265 1100A 690V	S86C2
TPD32-EV-575/680-2000-2B-D	6	170M 6267 1400A 690V	S85C2	170M 6267 1400A 690V	S85C2
TPD32-EV-575/680-2300-2B-D	12	170M 6263 900A 690V	S86C1	170M 6263 900A 690V	S86C1
TPD32-EV-690/810-560-2B-C	3	170M 5461 550A 690V	S85C11	170M 5461 550A 690V	S85C11
TPD32-EV-690/810-700-2B-C	3	170M 5463 700A 690V	S7791	170M 5463 700A 690V	S7791
TPD32-EV-690/810-900-2B-C	3	170M 5465 900A 690V	S7793	170M 5465 900A 690V	S7793
TPD32-EV-690/810-1300-2B-D	6	170M 6263 900A 690V	S86C1	170M 6263 900A 690V	S86C1
TPD32-EV-690/810-1600-2B-D	6	170M 6265 1100A 690V	S86C2	170M 6265 1100A 690V	S86C2
TPD32-EV-690/810-1900-2B-D	6	170M 6267 1400A 690V	S85C2	170M 6267 1400A 690V	S85C2
TPD32-EV-690/810-2100-2B-D	12	170M 6262 800A 690V	S85C3	170M 6262 800A 690V	S85C3
TPD32 EV-690/810-1010-2B-E	6	170M 5463 700A 660V	S7791	170M 5463 700A 660V	S7791
TPD32 EV-690/810-1400-2B-E	6	170M 6463 900A 660V	S7798	170M 6463 900A 660V	S7798
TPD32 EV-690/810-1700-2B-E	6	170M 6465 1100A 660V	S7801	170M 6465 1100A 660V	S7801
TPD32 EV-690/810-2000-2B-E	6	170M 6466 1250A 660V	S7802	170M 6466 1250A 660V	S7802
TPD32 EV-690/810-2400-2B-E	12	170M 6461 700A 660V	S7796	170M 6461 700A 660V	S7796
TPD32 EV-690/810-2700-2B-E	12	170M 6462 800A 660V	S7797	170M 6462 800A 660V	S7797
TPD32 EV-690/810-3300-2B-E	12	170M 6466 1250A 660V	S7802	170M 6466 1250A 660V	S7802
TPD32 EV-500/520-770-4B-C	6	170M 5462 630A 660V	S825B	170M 5462 630A 660V	S825B
TPD32 EV-500/520-1050-4B-C	6	G2MUF02 800A 660V	S826B	170M 5464 800A 660V	S7792
TPD32-EV-500/520-1400-4B-D	6	170M 6263 900A 690V	S86C1	170M 6263 900A 690V	S86C1
TPD32-EV-500/520-1600-4B-D	6	170M 6265 1100A 690V	S86C2	170M 6265 1100A 690V	S86C2
TPD32-EV-500/520-2000-4B-D	6	170M 6267 1400A 690V	S85C2	170M 6267 1400A 690V	S85C2
TPD32-EV-500/520-2400-4B-D	12	170M 6263 900A 690V	S86C1	170M 6263 900A 690V	S86C1
TPD32 EV-500/520-1500-4B-E	6	170M 5465 900A 660V	S7793	170M 5465 900A 660V	S7793
TPD32 EV-500/520-1700-4B-E	6	170M 6466 1250A 660V	S7802	170M 6466 1250A 660V	S7802
TPD32 EV-500/520-2000-4B-E	6	170M 6466 1250A 660V	S7802	170M 6466 1250A 660V	S7802
TPD32 EV-500/520-2400-4B-E	6	170M 6467 1400A 660V	S7803	170M 6467 1400A 660V	S7803
TPD32 EV-500/520-2700-4B-E	12	170M 6462 800A 660V	S7797	170M 6462 800A 660V	S7797
TPD32 EV-500/520-3300-4B-E	12	170M 6466 1250A 660V	S7802	170M 6466 1250A 660V	S7802
TPD32-EV-575/600-700-4B-C	6	170M 5394 500A 1250V	S85D3	170M 5394 500A 1250V	S85D3
TPD32-EV-575/600-1050-4B-C	6	170M 5398 800A 1000V	S85D2	170M 5398 800A 1000V	S85D2
TPD32-EV-575/600-1300-4B-D	6	170M 6247 900A 1250V	S85C7	170M 6247 900A 1250V	S85C7
TPD32-EV-575/600-1600-4B-D	6	170M 6249 1100A 1250V	S85C10	170M 6249 1100A 1250V	S85C10
TPD32-EV-575/600-2000-4B-D	12	170M 6245 700A 1250V	S85C5	170M 6245 700A 1250V	S85C5
TPD32-EV-575/600-2300-4B-D	12	170M 6247 900A 1250V	S85C7	170M 6247 900A 1250V	S85C7

European Drive Rating	Q.ty no.	Europe		America	
		Fuse type	Code	Fuse type	Code
TPD32-EV-690/720-560-4B-C	3	I70M 5392 400A 1250V	S85C12	I70M 5392 400A 1250V	S85C12
TPD32-EV-690/720-700-4B-C	3	I70M 5394 500A 1250V	S85D3	I70M 5394 500A 1250V	S85D3
TPD32-EV-690/720-900-4B-C	6	I70M 5396 630A 1100V	S85D1	I70M 5396 630A 1100V	S85D1
TPD32-EV-690/720-1300-4B-D	6	I70M 6247 900A 1250V	S85C7	I70M 6247 900A 1250V	S85C7
TPD32-EV-690/720-1600-4B-D	6	I70M 6249 1100A 1250V	S85C10	I70M 6249 1100A 1250V	S85C10
TPD32-EV-690/720-1900-4B-D	12	I70M 6245 700A 1250V	S85C5	I70M 6245 700A 1250V	S85C5
TPD32-EV-690/720-2100-4B-D	12	I70M 6246 800A 1250V	S85C6	I70M 6246 800A 1250V	S85C6
TPD32 EV-690/720-1010-4B-E	6	I70M 6345 700A 1250V	S7795	I70M 6345 700A 1250V	S7795
TPD32 EV-690/720-1400-4B-E	6	I70M 6497 900A 1250V	S7804	I70M 6497 900A 1250V	S7804
TPD32 EV-690/720-1700-4B-E	12	I70M 5394 500A 1250V	S85D3	I70M 5394 500A 1250V	S85D3
TPD32 EV-690/720-2000-4B-E	12	I70M 6344 630A 1250V	S7794	I70M 6344 630A 1250V	S7794
TPD32 EV-690/720-2400-4B-E	12	I70M 6345 700A 1250V	S7795	I70M 6345 700A 1250V	S7795
TPD32 EV-690/720-2700-4B-E	12	I70M 6346 800A 1250V	S7805	I70M 6346 800A 1250V	S7805
TPD32 EV-690/720-3300-4B-E	12	I70M 6500 1250A 1100V	S7806	I70M 6500 1250A 1100V	S7806

American Drive Rating	Q.ty no.	America	
		Fuse type	Code
TPD32-EV-500/600-560-2B-C-NA	3	I70M 5464 800A 660V	S7792
TPD32-EV-500/600-800-2B-C-NA	3	I70M 5466 1000A 660V	S827B
TPD32-EV-500/600-1000-2B-D-NA	6	I70M 6263 900A 690V	S86C1
TPD32-EV-500/600-1200-2B-D-NA	6	I70M 6265 1100A 690V	S86C2
TPD32-EV-500/600-1500-2B-D-NA	6	I70M 6267 1400A 690V	S85C2
TPD32-EV-500/600-1850-2B-D-NA	12	I70M 6263 900A 690V	S86C1
TPD32-EV-500/600-1000-2B-E-NA	6	I70M 5464 800A 660V	S7792
TPD32-EV-500/600-1300-2B-E-NA	6	I70M 6464 1000A 660V	S7799
TPD32-EV-500/600-1400-2B-E-NA	6	I70M 6466 1250A 660V	S7802
TPD32-EV-500/600-1500-2B-E-NA	6	I70M 6466 1250A 660V	S7802
TPD32-EV-500/600-1800-2B-E-NA	6	I70M 6467 1400A 660V	S7803
TPD32-EV-500/600-2000-2B-E-NA	12	I70M 6462 800A 660V	S7797
TPD32-EV-500/600-2200-2B-E-NA	12	I70M 6463 900A 660V	S7798
TPD32-EV-500/600-2350-2B-E-NA	12	I70M 6466 1250A 660V	S7802
TPD32-EV-575/680-490-2B-C-NA	3	I70M 5463 700A 690V	S7791
TPD32-EV-575/680-750-2B-C-NA	3	I70M 5466 1000A 690V	S827B
TPD32-EV-575/680-980-2B-D-NA	6	I70M 6263 900A 690V	S86C1
TPD32-EV-575/680-1200-2B-D-NA	6	I70M 6265 1100A 690V	S86C2
TPD32-EV-575/680-1500-2B-D-NA	6	I70M 6267 1400A 690V	S85C2
TPD32-EV-575/680-1800-2B-D-NA	12	I70M 6263 900A 690V	S86C1
TPD32-EV-690/810-360-2B-C-NA	3	I70M 5461 550A 690V	S85C11
TPD32-EV-690/810-490-2B-C-NA	3	I70M 5463 700A 690V	S7791
TPD32-EV-690/810-650-2B-C-NA	3	I70M 5465 900A 690V	S7793
TPD32-EV-690/810-920-2B-D-NA	6	I70M 6263 900A 690V	S86C1
TPD32-EV-690/810-1200-2B-D-NA	6	I70M 6265 1100A 690V	S86C2
TPD32-EV-690/810-1450-2B-D-NA	6	I70M 6267 1400A 690V	S85C2
TPD32-EV-690/810-1650-2B-D-NA	12	I70M 6262 800A 690V	S85C3
TPD32-EV-690/810-900-2B-E-NA	6	I70M 5463 700A 660V	S7791
TPD32-EV-690/810-1150-2B-E-NA	6	I70M 6463 900A 660V	S7798
TPD32-EV-690/810-1350-2B-E-NA	6	I70M 6465 1100A 660V	S7801
TPD32-EV-690/810-1500-2B-E-NA	6	I70M 6466 1250A 660V	S7802
TPD32-EV-690/810-1800-2B-E-NA	12	I70M 6461 700A 660V	S7796

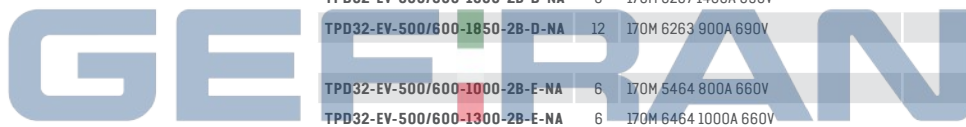

 نماینده رسمی جفران ایتالیا در ایران

American Drive Rating	Q.ty no.	Fuse type	America	Code
TPD32-EV-690/810-2000-2B-E-NA	12	170M 6462 800A 660V		S7797
TPD32-EV-690/810-2350-2B-E-NA	12	170M 6466 1250A 660V		S7802
TPD32-EV-500/520-560-4B-C-NA	6	170M 5462 630A 660V		S825B
TPD32-EV-500/520-850-4B-C-NA	6	170M 5464 800A 660V		S7792
TPD32-EV-500/520-1000-4B-D-NA	6	170M 6263 900A 690V		S86C1
TPD32-EV-500/520-1200-4B-D-NA	6	170M 6265 1100A 690V		S86C2
TPD32-EV-500/520-1500-4B-D-NA	6	170M 6267 1400A 690V		S85C2
TPD32-EV-500/520-1850-4B-D-NA	12	170M 6263 900A 690V		S86C1
TPD32-EV-500/520-1300-4B-E-NA	6	170M 5465 900A 660V		S7793
TPD32-EV-500/520-1350-4B-E-NA	6	170M 6466 1250A 660V		S7802
TPD32-EV-500/520-1500-4B-E-NA	6	170M 6466 1250A 660V		S7802
TPD32-EV-500/520-1800-4B-E-NA	6	170M 6467 1400A 660V		S7803
TPD32-EV-500/520-2000-4B-E-NA	12	170M 6462 800A 660V		S7797
TPD32-EV-500/520-2350-4B-E-NA	12	170M 6466 1250A 660V		S7802
TPD32-EV-575/600-490-4B-C-NA	6	170M 5394 500A 1250V		S85D3
TPD32-EV-575/600-750-4B-C-NA	6	170M 5398 800A 1000V		S85D2
TPD32-EV-575/600-980-4B-D-NA	6	170M 6247 900A 1250V		S85C7
TPD32-EV-575/600-1200-4B-D-NA	6	170M 6249 1100A 1250V		S85C10
TPD32-EV-575/600-1500-4B-D-NA	12	170M 6245 700A 1250V		S85C5
TPD32-EV-575/600-1800-4B-D-NA	12	170M 6247 900A 1250V		S85C7
TPD32-EV-690/720-360-4B-C-NA	6	170M 5392 400A 1250V		S85C12
TPD32-EV-690/720-490-4B-C-NA	6	170M 5394 500A 1250V		S85D3
TPD32-EV-690/720-650-4B-C-NA	6	170M 5396 630A 1100V		S85D1
TPD32-EV-690/720-980-4B-D-NA	6	170M 6247 900A 1250V		S85C7
TPD32-EV-690/720-1200-4B-D-NA	6	170M 6249 1100A 1250V		S85C10
TPD32-EV-690/720-1450-4B-D-NA	12	170M 6245 700A 1250V		S85C5
TPD32-EV-690/720-1650-4B-D-NA	12	170M 6246 800A 1250V		S85C6
TPD32-EV-690/720-900-4B-E-NA	6	170M 6345 700A 1250V		S7795
TPD32-EV-690/720-1150-4B-E-NA	6	170M 6497 900A 1250V		S7804
TPD32-EV-690/720-1350-4B-E-NA	12	170M 5394 500A 1250V		S85D3
TPD32-EV-690/720-1500-4B-E-NA	12	170M 6344 630A 1250V		S7794
TPD32-EV-690/720-1800-4B-E-NA	12	170M 6345 700A 1250V		S7795
TPD32-EV-690/720-2000-4B-E-NA	12	170M 6346 800A 1250V		S7805
TPD32-EV-690/720-2350-4B-E-NA	12	170M 6500 1250A 1100V		S7806

GEFRAN

نماینده رسمی جفران ایتالیا در ایران

Fd • Internal fuses for the field circuit

FD • Fusibili interni per il circuito di campo
 FD • Fusibles internes pour le circuit de champ
 FD • Interne Sicherungen für den Feldkreis
 FD • Fusibles internos para el rotor

 These fuses are internally mounted and are provided on the delivery.

 Questi fusibili sono montati internamente e sono parte integrante della fornitura.

 Ces fusibles sont montés en interne et font partie intégrante de la fourniture.

 Diese Sicherungen sind intern eingebaut und sind wesentlicher Bestandteil der Lieferung.

 Estos fusibles están montados internamente y forman parte integrante del suministro.

European Drive Rating	Q.ty no.	Fuse type	Code
TPD32 EV-.../...-...-A	2	500 V 16 A fast	S824B
TPD32 EV-.../...-...-B	2	600 V 25 A fast	S823B
TPD32 EV-.../...-...-C	2	600 V 25 A fast	S823B
TPD32 EV-.../...-1300-...-D to TPD32 EV-.../...-2000-...-D	2	600 V 50 A fast	F4M15
TPD32 EV-.../...-2100-...-D to TPD32 EV-.../...-2400-...-D	2	600 V 100 A fast	F4M21
TPD32 EV-.../...-1010-...-E to TPD32 EV-.../...-2000-...-E	2	600 V 50 A fast	F4M15
TPD32 EV-.../...-2400-...-E to TPD32 EV-.../...-3300-...-E	2	600 V 100 A fast	F4M21

American Drive Rating	Q.ty no.	Fuse type	Code
TPD32 EV-.../...-...-A-NA	2	500 V 16 A fast	S824B
TPD32 EV-.../...-...-B-NA	2	600 V 25 A fast	S823B
TPD32 EV-.../...-...-C-NA	2	600 V 25 A fast	S823B
TPD32 EV-.../...-920-...-D to TPD32 EV-.../...-1500-...-D-NA	2	600 V 50 A fast	F4M15
TPD32 EV-.../...-1650-...-D to TPD32 EV-.../...-1850-...-D-NA	2	600 V 100 A fast	F4M21
TPD32 EV-.../...-1000-...-E to TPD32 EV-.../...-1500-...-E-NA	2	600 V 50 A fast	F4M15
TPD32 EV-.../...-1800-...-E to TPD32 EV-.../...-2350-...-E-NA	2	600 V 100 A fast	F4M21

TPD32-EV-CU-...	Q.ty no.	Fuse type	Code
TPD32-EV-CU-.../...-...-40	2	600 V 50 A fast	F4M15
TPD32-EV-CU-.../...-...-70	2	600 V 100 A fast	F4M21

GEFRAN

نماینده رسمی جفران ایتالیا در ایران

 The fuse technical data, such as dimensions, weights, dissipated power, heat etc. can be found in the relevant fuse manufacturer catalogues (5014006...=SIBA; FWP...=Bussmann; A70...=Ferraz-Shawmut).

 I dati tecnici dei fusibili, come ad esempio dimensioni, peso, dissipazione, calore, ecc. sono disponibili nei relativi cataloghi del costruttore fusibili (5014006...=SIBA; FWP...=Bussmann; A70...=Ferraz-Shawmut).

 Les caractéristiques techniques des fusibles telles que, les dimensions, le poids, la dissipation, etc., sont indiquées dans les catalogues correspondants du fabricant de fusibles (5014006...=SIBA; FWP...=Bussmann; A70...=Ferraz-Shawmut).

 Die technischen Daten der Sicherungen, wie beispielsweise Abmessungen, Gewicht, Verlustleistung, Wärme, usw. sind den entsprechenden Katalogen der Sicherungshersteller zu entnehmen (5014006...=SIBA; FWP...=Bussmann; A70...=Ferraz-Shawmut).

 Los datos técnicos de los fusibles, tales como dimensiones, peso, energía disipada, calor, etc. se pueden encontrar en los catálogos de fabricantes de fusibles (5014006...=SIBA; FWP...=Bussmann; A70...=Ferraz-Shawmut).

TPD32-EV-FC, Power side fuses

Fusibili dalla parte di potenza
Fusibles de la partie de puissance
Sicherungen am Leistungsteil
Fusibles de la parte de potencia



The fuse technical data, such as dimensions, weights, dissipated power, heat etc. can be found in the relevant fuse manufacturer catalogues (Z.= Jean Muller; FWP.., I70M.= Bussmann; A.=Gould Shawmut).



I dati tecnici dei fusibili, come ad esempio dimensioni, peso, dissipazione, calore, ecc. sono disponibili nei relativi cataloghi del costruttore fusibili (Z.= Jean Muller; FWP.., I70M.= Bussmann; A.=Gould Shawmut).



Les caractéristiques techniques des fusibles telles que, les dimensions, le poids, la dissipation, etc., sont indiquées dans les catalogues correspondants du fabricant de fusibles (Z.= Jean Muller; FWP.., I70M.= Bussmann; A.=Gould Shawmut).



Die technischen Daten der Sicherungen, wie beispielsweise Abmessungen, Gewicht, Verlustleistung, Wärme, usw. sind den entsprechenden Katalogen der Sicherungshersteller zu entnehmen (Z.= Jean Muller; FWP.., I70M.= Bussmann; A.=Gould Shawmut).



Los datos técnicos de los fusibles, tales como dimensiones, peso, energía disipada, calor, etc. se pueden encontrar en los catálogos de fabricantes de fusibles (Z.= Jean Muller; FWP.., I70M.= Bussmann; A.=Gould Shawmut).

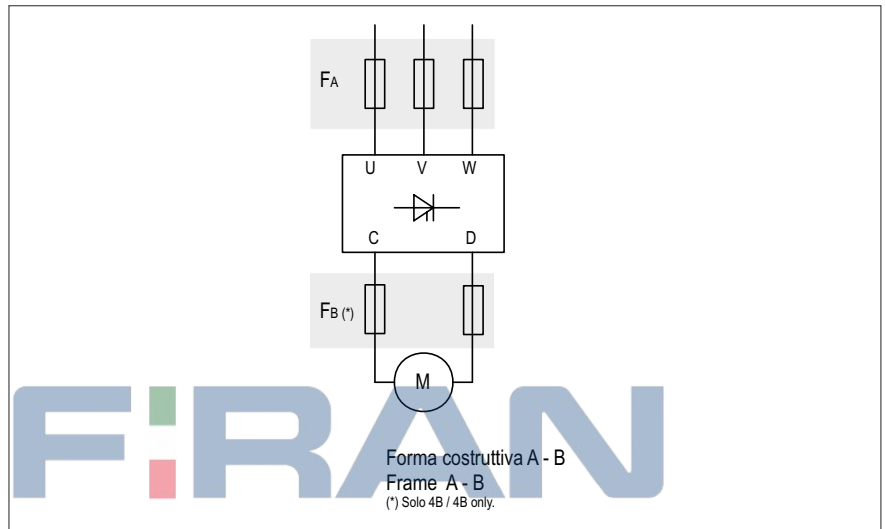

FA - Input Side External Fuses

FA · Fusibili esterni lato ingresso
FA · Fusibles réseau extérieures
FA · Externe Sicherungen Eingangsseite
FA · Fusibles externos del lado de alimentación de red

European Drive Rating	Q.ty no.	Europe Fuse type	Code	America Fuse type	Code
TPD32-EV-FC-.../...-20-...-A	3	Z14gR20	F4M07	A70P25	S7G51
TPD32-EV-FC-.../...-40-...-A	3	Z22gR50	F4M15	A70P40	S7G52
TPD32-EV-FC-.../...-70-...-A	3	Z22gR63	F4M17	A70P80	S7G54
TPD32-EV-FC-.../...-110-...-A	3	S00C+/üf1/80/100A/660V	F4EAG	A70P100	S7G55
TPD32-EV-FC-.../...-140-...-A	3	S00C+/üf1/80/125A/660V	F4EAJ	A70P150	S7G56
TPD32-EV-FC-.../...-185-...-A	3	S00üF1/80/200A/660V	F4G23	A70P175	S7G57
TPD32-EV-FC-.../...-280-...-B	3	S1üF1/110/250A/660V	F4G28	A70P300	S7G60
TPD32-EV-FC-.../...-350-...-B	3	S1üF1/110/315A/660V	F4G30	A70P350	S7G61
TPD32-EV-FC-.../...-420-...-B	3	S2üF1/110/400A/660V	F4G34	A70P400	S7G62
TPD32-EV-FC-.../...-500-...-B	3	S2üF1/110/500A/660V	F4E30	A70P500	S7G63
TPD32-EV-FC-.../...-650-...-B	3	S2üF1/110/630A/660V	F4E31	A70P600	S7G65

Fb · External fuses for the output circuit side (CD)

Fb · Fusibili esterni per il circuito di uscita (CD)
Fb · Fusibles externes pour le circuit de sortie (CD)
Fb · Externe Sicherungen für den Ausgangskreis (CD)
Fb · Fusibles externos para el circuito de salida (CD)

European Drive Rating	Q.ty no.	Europe Fuse type	Code	America Fuse type	Code
TPD32-EV-FC-.../...-20-4B-A	2	Z14gR20	F4M07	A70P25	S7G51
TPD32-EV-FC-.../...-40-4B-A	2	Z22gR63	F4M17	A70P80	S7G54
TPD32-EV-FC-.../...-70-4B-A	2	S00C+/üf1/80/100A/660V	F4EAG	A70P100	S7G55
TPD32-EV-FC-.../...-110-4B-A	2	S00C+/üf1/80/125A/660V	F4EAJ	A70P150	S7G56
TPD32-EV-FC-.../...-140-4B-A	2	S00C+/üf1/80/160A/660V	F4EAL	A70P175	S7G57
TPD32-EV-FC-.../...-185-4B-A	2	S00üF1/80/200A/660V	F4G23	A70P200	S7G58
TPD32-EV-FC-.../...-280-4B-B	2	S1üF1/110/315A/660V	F4G30	A70P350	S7G61
TPD32-EV-FC-.../...-350-4B-B	2	S2üF1/110/400A/660V	F4G34	A70P400	S7G62
TPD32-EV-FC-.../...-420-4B-B	2	S2üF1/110/500A/660V	F4E30	A70P500	S7G63
TPD32-EV-FC-.../...-500-4B-B	2	S2üF1/110/630A/660V	F4E31	A70P600	S7G65
TPD32-EV-FC-.../...-650-4B-B	2	S2üF1/110/710A/660V	F4G85	A70P700	S7G67

Input Chokes

Induttanze di rete,
Inductances de réseau,
Netzdröseln,
Inductancias de red.



AC Input chokes for TPD32-EV Drives

See table 5 (on page 57) for the combinations with coded mains chokes available for immediate delivery. Tables 1-2-3-4 show the mains choke electrical ratings, but not the relative codes. Please contact our sales network for further details.

According to EN 61800-3 standard (Table B.1), the max allowable depth of commutation notches in the Common Point is limited to 20% or 40% depending on the installation environment. This can be obtained by the installation of suitable decoupling reactors or transformers.

On the other hand, for proper operation, the drive shall be connected to an electrical supply line having a reactance with a relative voltage drop of between 2% (min) and 10% (max). The decoupling reactance requires a specific calculation based on the relative short-circuit power R_{sc} at the connection point and the actual type of connection (single or multiple drives, separating transformers, etc.). But, as an indication, the following tables list the decoupling reactance values L_d (mains spool) having a relative voltage drop of 2% or 4%. The value refers to a drive rated output current, but can be calculated for the motor DC rated current. The line current value is given by $I_{LN} = I_{dN} \times 0.82$. (On shown calculations a safety margin of +5% has been added). It should also be noted that drives having such a high relative voltage (500/575/690Vac) usually belong to the "second environment".

For 575 V type B TPD32 converters and 575/690 V type C converters, which are usually installed in a second-type environment: in this case UKD values of around 2% can be used, with the advantage that smaller reactors are required. Otherwise, if UKD must be = 4%, always comply with the values shown in the relative columns.

(Supply transformers of residential region with light industry have a rated power $P_N < 1.2MVA$. Furthermore, EN 61800-3 requires the rated power of the transformer to be at least 4 times the rated power of the PDS (Power Drive System) and this limits the available current, in some cases, below what required by these frames!).

The calculation formula is:

$$L_d = (U_{kd} \cdot U_{LN}) / (I_{dN} \cdot \sqrt{2} \cdot 2\pi \cdot f_N) \text{ or } L_d = (U_{kd} \cdot U_{LN}) / (I_{LN} \cdot \sqrt{3} \cdot 2\pi \cdot f_N) \quad [H]$$

This is a simplified method of calculation. The greater the ratio of available power to power of the drive installed ($> 4x$), the more accurate the calculation.



Induttanza di ingresso CA per drive TPD32-EV

Gli abbinamenti con induttanze di rete codificate e quindi disponibili per ordini immediati sono riportati nella tabella 5 (a pagina 57). Nelle tabelle 1-2-3-4 vengono invece indicati i soli dati elettrici delle induttanze di rete senza alcuna indicazione di codice, siete pregati di contattare direttamente la nostra rete vendita.

Secondo la norma EN 61800-3 (Tabella B.1), la profondità massima tollerabile dei buchi di commutazione nel Punto di Connessione è limitata al 20%-40% in base all'ambiente di installazione. Ciò può essere ottenuto installando reattori di disaccoppiamento o trasformatori idonei.

D'altra parte, per il corretto funzionamento, il drive deve essere collegato a una linea di alimentazione elettrica avente una reattanza con una caduta di tensione relativa compresa tra un min. del 2% a un max del 10%. In base al valore della potenza di cortocircuito relativa R_{sc} nel punto di connessione e alla configurazione del collegamento stesso (drive singoli o multipli, trasformatori di separazione, eccetera), la reattanza di disaccoppiamento richiede un calcolo specifico. Tuttavia, come indicazione, le tabelle seguenti elencano valori della reattanza di disaccoppiamento L_d (bobine della rete) aventi una caduta di tensione relativa del 2% o del 4%. Il valore si riferisce a una corrente in uscita nominale del drive, ma può essere calcolato per la corrente nominale DC del motore. Il valore della corrente della linea è dato da $I_{LN} = I_{dN} \times 0.82$. (Sui calcoli riportati è stato aggiunto un margine di sicurezza del +5%). Occorre anche notare che i drive con tensione di alimentazione relativamente elevata (500/575/690Vca) appartengono ad un ambiente di "secondo tipo" dove i reattori da 4% non sono mai strettamente necessari.

Per i convertitori TPD32-EV con forma costruttiva B a 575V e convertitori TPD32-EV con forma costruttiva C a 575/690V, solitamente installati in un ambiente di secondo tipo, si possono usare in questo caso i valori UKd prossimi al 2%, con il vantaggio di avere reattori più piccoli. Al contrario, se è obbligatorio UKd = 4%, osservare i valori riportati sulle relative colonne.

(I trasformatori di alimentazione di una regione residenziale con un'industria leggera hanno una potenza nominale $P_N < 1.2 MVA$. Inoltre, EN 61800-3 richiede che la potenza nominale del trasformatore sia almeno 4 volte superiore alla potenza nominale del PDS (Power Drive System) e talvolta ciò limita la corrente disponibile al di sotto di quanto richiesto da queste dimensioni!).

La formula di calcolo è:

$$L_d = (U_{kd} \cdot U_{LN}) / (I_{dN} \cdot \sqrt{2} \cdot 2\pi \cdot f_N) \text{ o } L_d = (U_{kd} \cdot U_{LN}) / (I_{LN} \cdot \sqrt{3} \cdot 2\pi \cdot f_N) \quad [H]$$

Questo metodo di calcolo è un metodo semplificato. È tanto più esatto quanto più è elevato il rapporto fra potenza disponibile e potenza del drive installato ($> 4x$).

Inductances de réseau CA pour convertisseurs TPD32-EV.

Les combinaisons avec des inductances de réseau codées, qui sont par conséquent disponibles pour des commandes immédiates, sont reproduites au tableau 5 (à la page 57).

Les tableaux 1-2-3-4 n'indiquent en revanche que les caractéristiques électriques des inductances de réseau, sans mention du code : nous vous prions donc de contacter directement notre réseau de vente.

Conformément à la norme EN 61800-3 (Tableau B.1), la profondeur maximale des entailles de commutation admissible dans le point de connexion est limitée à 20 % ou à 40 % en fonction de l'environnement d'installation. L'installation de réactances ou de transformateurs de découplage prévus à cet effet permet de l'obtenir.

D'autre part, pour pouvoir fonctionner correctement, le drive doit être raccordé à une ligne d'alimentation présentant une réactance avec une chute de potentiel correspondante comprise entre 2% minimum et 10 % maximum. En fonction de la valeur de la puissance de court-circuit correspondante Rsc sur le point de connexion et de la configuration de la connexion (drive simple, drives multiples, transformateurs de séparation, etc.), la réactance de découplage nécessite un calcul spécifique. Cependant, les tableaux suivants, fournis à titre de ligne directrice, répertorient des valeurs de réactance de découplage Ld (inductance du réseau électrique) avec une chute de potentiel correspondante de 2% ou de 4 %. Leur valeur se réfère au courant de sortie nominal du drive, mais elle peut néanmoins être calculée pour le courant nominal CC du moteur. La valeur du courant de ligne est donnée par $ILN = IdN \times 0.82$ (une marge de sécurité de +5 % a été ajoutée dans les calculs reproduits). Il convient également de noter que les drive à tension d'alimentation relativement élevée (500/575/690Vca) appartiennent à un environnement de "deuxième type" dans lequel les réacteurs à 4% ne sont jamais indispensables.

(Les transformateurs d'alimentation dans les environnements résidentiels ou d'industrie légère ont une puissance nominale $PN < 1.2MVA$. De plus, la norme EN 61800-3 suppose que le courant nominal du transformateur représente au moins 4 fois la puissance nominale du PDS (Power Drive System), ce qui, dans certains cas, limite le courant disponible en dessous de la valeur requise par ces cadres).

La formule de calcul est la suivante :

$Ld = (Ukd \cdot ULN) / (ILN \cdot \sqrt{2} \cdot 2\pi \cdot fn)$ ou $Ld = (Ukd \cdot ULN) / (ILN \cdot \sqrt{3} \cdot 2\pi \cdot fn [H])$ Cette méthode de calcul est une méthode simplifiée. Elle est d'autant plus précise que le rapport entre la puissance disponible et la puissance du drive installé ($> 4x$) est élevé.

Inductancias de red CA para convertidores TPD32-EV.

Los acoplamientos con inductancias de red codificadas y, por lo tanto, disponibles para pedidos inmediatos se muestran en la tabla 5 (pág. 57). En las tablas 1-2-3-4 se indican únicamente los datos eléctricos de las inductancias de red, sin las indicaciones de código (póngase en contacto directamente con nuestra red de ventas).

De acuerdo con la Normativa EN 61800-3 (Tabla B.1), la profundidad máxima permitida de las muescas de conmutación en el punto de conexión se limita al 20% o 40%, dependiendo del entorno de la instalación. Esto puede obtenerse a través de la instalación de transformadores o reactores de disociación adecuados.

Por otro lado, para un funcionamiento correcto, el convertidor debe estar conectado a una línea de alimentación que disponga de una reactancia con una caída de voltaje relativa de entre el 2% (mín.) y el 10% (máx.). Dependiendo del valor de la potencia de cortocircuito relativa Rsc en el punto de conexión y de la propia configuración de conexión (con uno o varios convertidores, transformadores de separación, etc.), la reactancia de disociación requiere un cálculo específico. Sin embargo, como guía, las tablas siguientes listan valores de Ld (reactancias de red) de reactancia de disociación con una caída de voltaje relativa del 2% o el 4%. Su valor se refiere a la intensidad nominal de salida del convertidor, pero pueden calcularse eventualmente para la intensidad nominal del motor CC. El valor de corriente de línea está proporcionado por $ILN = IdN \times 0.82$. (Se ha añadido un margen de seguridad del +5% en los cálculos que se muestran). También debe tenerse en cuenta que los convertidores con tensión de alimentación relativamente alta (500/575/690Vca) pertenecen a un entorno de "segundo tipo", donde los reactores del 4% nunca son estrictamente necesarios.

(Los transformadores de alimentación de regiones residenciales con industria ligera disponen de una potencia nominal $PN < 1.2MVA$. Además, la norma EN 61800-3 requiere una potencia nominal del transformador de al menos 4 veces la potencia nominal del PDS (Power Drive System) y esto limita la corriente disponible, en algunos casos, por debajo de lo que requieren estos chasis).

La fórmula de cálculo es:

$Ld = (Ukd \cdot ULN) / (ILN \cdot \sqrt{2} \cdot 2\pi \cdot fn)$ o $Ld = (Ukd \cdot ULN) / (ILN \cdot \sqrt{3} \cdot 2\pi \cdot fn [H])$

Este método de cálculo es un método simplificado.

Es más preciso cuanto más alta es la relación entre la potencia disponible y la potencia del convertidor instalado ($> 4x$).

AC-Netzdröseln für Stromrichter TPD32-EV.

Die Kombinationen mit codierten Netzdröseln, die daher sofort bestellt werden können, sind in Tabelle 5 (auf Seite 57) angeführt.

In den Tabellen 1-2-3-4 werden hingegen nur die elektrischen Daten der Netzdröseln ohne Angabe von Codes angegeben; bitte wenden Sie sich direkt an unser Verkaufnetz.

Laut Standard EN 61800-3 (Tabelle B.1) ist die höchstzulässige Tiefe der Kommutierungseinbrüche auf dem Anschlusspunkt je nach Installationsumgebung auf 20% oder 40% beschränkt. Dies kann durch die Installation passender Entkopplungsdröseln oder Trafo erzielt werden.

Andererseits muss der Antrieb an eine Versorgungsleitung mit einer Reaktanz mit entsprechendem Spannungsabfall zwischen mind. 2% und max. 10% angeschlossen werden, um einwandfrei arbeiten zu können. Je nach relativer Kurzschlussleistung, Rsc-Wert auf dem Anschlusspunkt und der Anschlusskonfiguration selbst (einzelner oder mehrere Antriebe, Trenntrafos usw.) erfordert die Entkopplungsdrösel eine eigene Berechnung. In den folgenden Tabellen sind als Richtlinie die Werte der Entkopplungsdröseln Ld (Netzdröseln) mit einem entsprechenden Spannungsabfall von 2% oder 4% angeführt. Ihr Wert bezieht sich auf den geschätzten Antriebs-Ausgangsstrom, sie können jedoch eventuell für den geschätzten DC-Motorstrom berechnet werden. Der Leitungsstromwert ist durch $ILN = IdN \times 0.82$ gegeben (+5% Sicherheitsmarge wurde bei den gezeigten Berechnungen hinzugefügt). Es muss auch darauf hingewiesen werden, dass die Antriebe mit einer relativ hohen Versorgungsspannung (500/575/690VAC) einer Umgebung vom „Typ zwei“ angehören, wo die Spulen zu 4% nie unbedingt notwendig sind.

(Versorgungstrafos für Wohngebiete mit leichter Industrie haben eine geschätzte Leistung von $PN < 1.2MVA$. Überdies verlangt die EN 61800-3, dass die geschätzte Trafoleistung mindestens 4 Mal der geschätzten PDS-Leistung entsprechen muss (Power Drive System), und dies beschränkt den verfügbaren Strom in manchen Fällen unter den Wert, der von diesen Frames verlangt wird).

Die Berechnungsformel lautet:

$Ld = (Ukd \cdot ULN) / (ILN \cdot \sqrt{2} \cdot 2\pi \cdot fn)$ oder $Ld = (Ukd \cdot ULN) / (ILN \cdot \sqrt{3} \cdot 2\pi \cdot fn [H])$

Diese Berechnungsmethode ist eine vereinfachte Methode. Sie ist umso genauer, je höher das Verhältnis zwischen verfügbarer Leistung und Leistung des installierten Antriebs ist ($> 4x$).

Table 1: AC Input chokes for TPD32 at 400V Drives

European Drive Rating	Rated drive current [A]	Rated Inductance with Ukd=2% [µH]	Rated Inductance with Ukd=4% [µH]	Rated reactor current (+5%) [A]
AC Mains 400 V, 3Ph, 50 Hz				
TPD32-EV-500/...-20-...-A	20	900.3	1800.6	17
TPD32-EV-500/...-40-...-A	40	450.2	900.3	34
TPD32-EV-500/...-70-...-A	70	257.2	514.5	60
TPD32-EV-500/...-110-...-A	110	163.7	327.4	95
TPD32-EV-500/...-140-...-A	140	128.6	257.2	121
TPD32-EV-500/...-185-...-A	185	97.3	194.7	159
TPD32-500/...-280-...-B	280	64.3	128.6	241
TPD32-500/...-350-...-B	350	51.4	102.9	301
TPD32-500/...-420-...-B	420	42.9	85.7	362
TPD32-500/...-500-...-B	500	36.0	72.0	431
TPD32-500/...-650-...-B	650	27.7	55.4	560
TPD32-EV-500/...-770-...-C	770	23.4	46.8	663
TPD32-EV-500/...-1000-...-C	1000	18.0	36.0	861
TPD32-EV-500/...-1050-...-C	1050	17.1	34.3	904
TPD32-EV-500/...-1400-...-D	1400	12.9	25.7	1205
TPD32-EV-500/...-1600-...-D	1600	11.3	22.5	1378
TPD32-EV-500/...-2000-...-D	2000	9.0	18.0	1722
TPD32-EV-500/...-2400-...-D	2400	7.5	15.0	2066
TPD32-EV-500/...-1200-...-E	1200	15.0	30.0	1033
TPD32-EV-500/...-1500-...-E	1500	12.0	24.0	1292
TPD32-EV-500/...-1700-...-E	1700	10.6	21.2	1464
TPD32-EV-500/...-1800-...-E	1800	10.0	20.0	1550
TPD32-EV-500/...-2000-...-E	2000	9.0	18.0	1722
TPD32-EV-500/...-2400-...-E	2400	7.5	15.0	2066
TPD32-EV-500/...-2700-...-E	2700	6.7	13.3	2325
TPD32-EV-500/...-2900-...-E	2900	6.2	12.4	2497
TPD32-EV-500/...-3300-...-E	3300	5.5	10.9	2841

AC Mains 400 V, 3Ph, 60 Hz

TPD32-EV-500/...-20-...-A	20	750.3	1500.5	17
TPD32-EV-500/...-40-...-A	40	375.1	750.3	34
TPD32-EV-500/...-70-...-A	70	214.4	428.7	60
TPD32-EV-500/...-110-...-A	110	136.4	272.8	95
TPD32-EV-500/...-140-...-A	140	107.2	214.4	121
TPD32-EV-500/...-185-...-A	185	81.1	162.2	159
TPD32-500/...-280-...-B	280	53.6	107.2	241
TPD32-500/...-350-...-B	350	42.9	85.7	301
TPD32-500/...-420-...-B	420	35.7	71.5	362
TPD32-500/...-500-...-B	500	30.0	60.0	431
TPD32-500/...-650-...-B	650	23.1	46.2	560
TPD32-EV-500/...-770-...-C	770	19.5	39.0	663
TPD32-EV-500/...-1000-...-C	1000	15.0	30.0	861
TPD32-EV-500/...-1050-...-C	1050	14.3	28.6	904
TPD32-EV-500/...-1400-...-D	1400	10.7	21.4	1205
TPD32-EV-500/...-1600-...-D	1600	9.4	18.8	1378
TPD32-EV-500/...-2000-...-D	2000	7.5	15.0	1722
TPD32-EV-500/...-2400-...-D	2400	6.3	12.5	2066
TPD32-EV-500/...-1200-...-E	1200	12.5	25.0	1033
TPD32-EV-500/...-1500-...-E	1500	10.0	20.0	1292
TPD32-EV-500/...-1700-...-E	1700	8.8	17.7	1464
TPD32-EV-500/...-1800-...-E	1800	8.3	16.7	1550
TPD32-EV-500/...-2000-...-E	2000	7.5	15.0	1722
TPD32-EV-500/...-2400-...-E	2400	6.3	12.5	2066
TPD32-EV-500/...-2700-...-E	2700	5.6	11.1	2325
TPD32-EV-500/...-2900-...-E	2900	5.2	10.3	2497
TPD32-EV-500/...-3300-...-E	3300	4.5	9.1	2841

TPD32-EV-FC-...: reference should be made to the corresponding voltage and current sizes.
 TPD32-EV-FC-...: fare riferimento alle corrispondenti taglie in tensione e corrente.
 TPD32-EV-FC-...: faire référence aux grandeurs correspondantes en tension et courant.

Table 2: AC Input chokes for TPD32 at 500V Drives

European Drive Rating	Rated drive current [A]	Rated Inductance with Ukd=2% [µH]	Rated Inductance with Ukd=4% [µH]	Rated reactor current (+5%) [A]
AC Mains 500 V, 3Ph, 50 Hz				
TPD32-EV-500/...-20-...-A	20	1125.4	2250.8	17
TPD32-EV-500/...-40-...-A	40	562.7	1125.4	34
TPD32-EV-500/...-70-...-A	70	321.5	643.1	60
TPD32-EV-500/...-110-...-A	110	204.6	409.2	95
TPD32-EV-500/...-140-...-A	140	160.8	321.5	121
TPD32-EV-500/...-185-...-A	185	121.7	243.3	159
TPD32-500/...-280-...-B	280	80.4	160.8	241
TPD32-500/...-350-...-B	350	64.3	128.6	301
TPD32-500/...-420-...-B	420	53.6	107.2	362
TPD32-500/...-500-...-B	500	45.0	90.0	431
TPD32-500/...-650-...-B	650	34.6	69.3	560
TPD32-EV-500/...-770-...-C	770	29.2	58.5	663
TPD32-EV-500/...-1000-...-C	1000	22.5	45.0	861
TPD32-EV-500/...-1050-...-C	1050	21.4	42.9	904
TPD32-EV-500/...-1400-...-D	1400	16.1	32.2	1205
TPD32-EV-500/...-1600-...-D	1600	14.1	28.1	1378
TPD32-EV-500/...-2000-...-D	2000	11.3	22.5	1722
TPD32-EV-500/...-2400-...-D	2400	9.4	18.8	2066
TPD32-EV-500/...-1200-...-E	1200	18.8	37.5	1033
TPD32-EV-500/...-1500-...-E	1500	15.0	30.0	1292
TPD32-EV-500/...-1700-...-E	1700	13.2	26.5	1464
TPD32-EV-500/...-1800-...-E	1800	12.5	25.0	1550
TPD32-EV-500/...-2000-...-E	2000	11.3	22.5	1722
TPD32-EV-500/...-2400-...-E	2400	9.4	18.8	2066
TPD32-EV-500/...-2700-...-E	2700	8.3	16.7	2325
TPD32-EV-500/...-2900-...-E	2900	7.8	15.5	2497
TPD32-EV-500/...-3300-...-E	3300	6.8	13.6	2841

AC Mains 500 V, 3Ph, 60 Hz

TPD32-EV-500/...-20-...-A	20	937.8	1875.7	17
TPD32-EV-500/...-40-...-A	40	468.9	937.8	34
TPD32-EV-500/...-70-...-A	70	268.0	535.9	60
TPD32-EV-500/...-110-...-A	110	170.5	341.0	95
TPD32-EV-500/...-140-...-A	140	134.0	268.0	121
TPD32-EV-500/...-185-...-A	185	101.4	202.8	159
TPD32-500/...-280-...-B	280	67.0	134.0	241
TPD32-500/...-350-...-B	350	53.6	107.2	301
TPD32-500/...-420-...-B	420	44.7	89.3	362
TPD32-500/...-500-...-B	500	37.5	75.0	431
TPD32-500/...-650-...-B	650	28.9	57.7	560
TPD32-EV-500/...-770-...-C	770	24.4	48.7	663
TPD32-EV-500/...-1000-...-C	1000	18.8	37.5	861
TPD32-EV-500/...-1050-...-C	1050	17.9	35.7	904
TPD32-EV-500/...-1400-...-D	1400	13.4	26.8	1205
TPD32-EV-500/...-1600-...-D	1600	11.7	23.4	1378
TPD32-EV-500/...-2000-...-D	2000	9.4	18.8	1722
TPD32-EV-500/...-2400-...-D	2400	7.8	15.6	2066
TPD32-EV-500/...-1200-...-E	1200	15.6	31.3	1033
TPD32-EV-500/...-1500-...-E	1500	12.5	25.0	1292
TPD32-EV-500/...-1700-...-E	1700	11.0	22.1	1464
TPD32-EV-500/...-1800-...-E	1800	10.4	20.8	1550
TPD32-EV-500/...-2000-...-E	2000	9.4	18.8	1722
TPD32-EV-500/...-2400-...-E	2400	7.8	15.6	2066
TPD32-EV-500/...-2700-...-E	2700	6.9	13.9	2325
TPD32-EV-500/...-2900-...-E	2900	6.5	12.9	2497
TPD32-EV-500/...-3300-...-E	3300	5.7	11.4	2841

TPD32-EV-FC-...: siehe die entsprechenden Spannungs- und Stromgrößen.
 TPD32-EV-FC-...: consulte los tamaños correspondientes de tensión y corriente.

Table 3: AC Input chokes for TPD32 at 575V Drives

European Drive Rating	Rated drive current [A]	Rated Inductance with Ukd=2% [µH]	Rated Inductance with Ukd=4% [µH]	Rated reactor current (+5%) [A]
AC Mains 575 V, 3Ph, 50 Hz				
TPD32-EV-575/...-280-...-B	280	92.4	184.9	241
TPD32-EV-575/...-350-...-B	350	74.0	147.9	301
TPD32-EV-575/...-420-...-B	420	61.6	123.3	362
TPD32-EV-575/...-500-...-B	500	51.8	103.5	431
TPD32-EV-575/...-650-...-B	650	39.8	79.6	560
TPD32-EV-575/...-700-...-C	700	37.0	74.0	603
TPD32-EV-575/...-1000-...-C	1000	25.9	51.8	861
TPD32-EV-575/...-1050-...-C	1050	24.7	49.3	904
TPD32-EV-575/...-1300-...-D	1300	19.9	39.8	1119
TPD32-EV-575/...-1600-...-D	1600	16.2	32.4	1378
TPD32-EV-575/...-2000-...-D	2000	12.9	25.9	1722
TPD32-EV-575/...-2300-...-D	2300	11.3	22.5	1980
TPD32-EV-690/...-1010-...-E	1010	25.6	51.3	870
TPD32-EV-690/...-1400-...-E	1400	18.5	37.0	1205
TPD32-EV-690/...-1700-...-E	1700	15.2	30.5	1464
TPD32-EV-690/...-2000-...-E	2000	12.9	25.9	1722
TPD32-EV-690/...-2400-...-E	2400	10.8	21.6	2066
TPD32-EV-690/...-2700-...-E	2700	9.6	19.2	2325
TPD32-EV-690/...-3300-...-E	3300	7.8	15.7	2841
AC Mains 575 V, 3Ph, 60 Hz				
TPD32-EV-.../...-280-...-B	280	77.0	154.1	241
TPD32-EV-.../...-350-...-B	350	61.6	123.3	301
TPD32-EV-.../...-420-...-B	420	51.4	102.7	362
TPD32-EV-.../...-500-...-B	500	43.1	86.3	431
TPD32-EV-.../...-560-...-B	650	33.2	66.4	560
TPD32-EV-575/...-700-...-C	700	30.8	61.6	603
TPD32-EV-575/...-1000-...-C	1000	21.6	43.1	861
TPD32-EV-575/...-1050-...-C	1050	20.5	41.1	904
TPD32-EV-575/...-1300-...-D	1300	16.6	33.2	1119
TPD32-EV-575/...-1600-...-D	1600	13.5	27.0	1378
TPD32-EV-575/...-2000-...-D	2000	10.8	21.6	1722
TPD32-EV-575/...-2300-...-D	2300	9.4	18.8	1980
TPD32-EV-690/...-1010-...-E	1010	21.4	42.7	870
TPD32-EV-690/...-1400-...-E	1400	15.4	30.8	1205
TPD32-EV-690/...-1700-...-E	1700	12.7	25.4	1464
TPD32-EV-690/...-2000-...-E	2000	10.8	21.6	1722
TPD32-EV-690/...-2400-...-E	2400	9.0	18.0	2066
TPD32-EV-690/...-2700-...-E	2700	8.0	16.0	2325
TPD32-EV-690/...-3300-...-E	3300	6.5	13.1	2841

Table 4: AC Input chokes for TPD32 at 690V Drives

European Drive Rating	Rated drive current [A]	Rated Inductance with Ukd=2% [µH]	Rated Inductance with Ukd=4% [µH]	Rated reactor current (+5%) [A]
AC Mains 690V, 3Ph, 50 Hz				
TPD32-EV-690/...-560-...-C	560	55.5	110.9	482
TPD32-EV-690/...-700-...-C	700	44.4	88.7	603
TPD32-EV-690/...-900-...-C	900	34.5	69.0	775
TPD32-EV-690/...-1300-...-D	1300	23.9	47.8	1119
TPD32-EV-690/...-1600-...-D	1600	19.4	38.8	1378
TPD32-EV-690/...-1900-...-D	1900	16.3	32.7	1636
TPD32-EV-690/...-2100-...-D	2100	14.8	29.6	1808
TPD32-EV-690/...-1010-...-E	1010	30.8	61.5	870
TPD32-EV-690/...-1400-...-E	1400	22.2	44.4	1205
TPD32-EV-690/...-1700-...-E	1700	18.3	36.5	1464
TPD32-EV-690/...-2000-...-E	2000	15.5	31.1	1722
TPD32-EV-690/...-2400-...-E	2400	12.9	25.9	2066
TPD32-EV-690/...-2700-...-E	2700	11.5	23.0	2325
TPD32-EV-690/...-3300-...-E	3300	9.4	18.8	2841
AC Mains 690V, 3Ph, 60 Hz				
TPD32-EV-690/...-560-...-C	560	46.2	92.4	482
TPD32-EV-690/...-700-...-C	700	37.0	74.0	603
TPD32-EV-690/...-900-...-C	900	28.8	57.5	775
TPD32-EV-690/...-1300-...-D	1300	19.9	39.8	1119
TPD32-EV-690/...-1600-...-D	1600	16.2	32.4	1378
TPD32-EV-690/...-1900-...-D	1900	13.6	27.2	1636
TPD32-EV-690/...-2100-...-D	2100	12.3	24.7	1808
TPD32-EV-690/...-1010-...-E	1010	25.6	51.3	870
TPD32-EV-690/...-1400-...-E	1400	18.5	37.0	1205
TPD32-EV-690/...-1700-...-E	1700	15.2	30.5	1464
TPD32-EV-690/...-2000-...-E	2000	12.9	25.9	1722
TPD32-EV-690/...-2400-...-E	2400	10.8	21.6	2066
TPD32-EV-690/...-2700-...-E	2700	9.6	19.2	2325
TPD32-EV-690/...-3300-...-E	3300	7.8	15.7	2841

TPD32-EV-FC-... : reference should be made to the corresponding voltage and current sizes.
 TPD32-EV-FC-... : fare riferimento alle corrispondenti taglie in tensione e corrente.
 TPD32-EV-FC-... : faire référence aux grandeurs correspondantes en tension et courant.

TPD32-EV-FC-... : siehe die entsprechenden Spannungs- und Stromgrößen.
 TPD32-EV-FC-... : consulte los tamaños correspondientes de tensión y corriente.

Table 5: coded AC Input mains chokes



In order to increase the operating safety (Mains noise, noise between the drives) of the converters belonging to the TPD32 EV series, it is necessary to mount on the device a three-phase input choke. The stated values comply with the suggestions listed in the appendix referring to the EN 50178 (VDE 0160) norms. TPD32-EV-FC-...: reference should be made to the corresponding voltage and current sizes.



Per migliorare la sicurezza di esercizio (disturbi di rete, disturbi reciproci tra i drive) dei convertitori della serie TPD32 EV è opportuno inserire a monte dell'apparecchio una induttanza di rete trifase. I valori indicati rispettano le raccomandazioni in appendice alle normative EN 50178 (VDE 0160). TPD32-EV-FC-...: fare riferimento alle corrispondenti taglie in tensione e corrente.



Pour optimiser la sécurité de service (parasites sur le réseau, parasites réciproques entre les variateurs) des convertisseurs de la série TPD32 EV il est préférable d'insérer en amont de l'appareil une inductance de réseau triphasé. Les valeurs indiquées respectent les recommandations en appendice des normes EN 50178 (VDE 0160). TPD32-EV-FC-...: faire référence aux grandeurs correspondantes en tension et courant.



Zur Verbesserung der Betriebssicherheit (Netzstörungen, gegenseitige Störungen zwischen den Antrieben) der Stromrichter der Serie TPD32 EV ist das Einfügen einer Dreiphasen-Netzdrössel am Eingang des Gerätes zweckmäßig. Die angegebenen Werte entsprechen den Empfehlungen aus dem Anhang von EN 50178 (VDE 0160). TPD32-EV-FC-...: siehe die entsprechenden Spannungs- und Stromgrößen.



Para mejorar la seguridad de ejercicio (perturbación de red, perturbaciones reciprocas entre las unidades) de los convertidores de la serie TPD32 EV es preciso conectar sobre el aparato una inductancia de red trifásica. Los valores indicados respetan las recomendaciones de apéndice en las normativas EN 50178 (VDE 0160). TPD32-EV-TPD32-EV-FC-...: consulte los tamaños correspondientes de tensión y corriente.

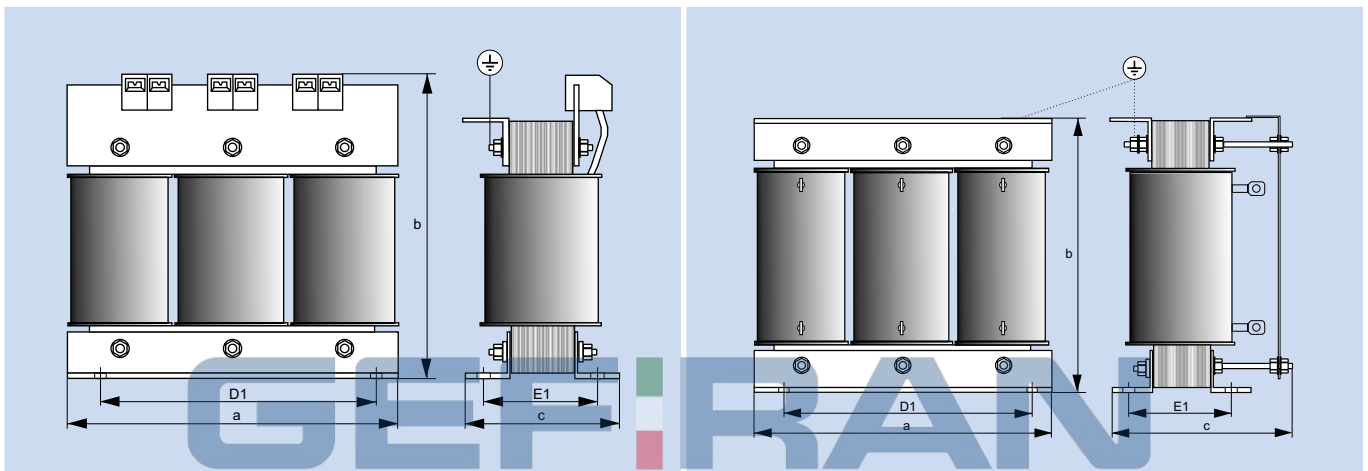

Drive Rating TPD32-EV-.../...-		Rated choke	Rated current	Saturation current	Freq.	Choke type	Choke code	Dimensions mm [inches]					Weight
European	America	[mH]	[A]	[A]	[Hz]			a	b	c	D1	E1	kg [lbs]
Mains: 400-460 V, 3Ph, 50 Hz (European) / Mains: 400-500 V, 3Ph, 60 Hz (America)													
-20-...-A	-17-...-NA-A	1.62	22	42	50/60	LR3-011	S7FF6	180 [7.1]	183 [7.2]	125 [4.9]	150 [5.9]	80 [3.1]	8 [17.6]
-40-...-A	-35-...-NA-A	0.68	41	61	50/60	LR3-41-61-0,68	S7D03	180 [7.1]	165 [6.5]	160 [6.3]	150 [5.9]	82 [3.2]	10 [22.0]
-70-...-A	-56-...-NA-A	0.45	61	91	50/60	LR3-61-91-0,45	S7D04	180 [7.1]	165 [6.5]	185 [7.3]	150 [5.9]	97 [3.8]	15 [33.1]
-110-...-A	-88-...-NA-A	0.3	90	135	50/60	LR3-90-135-0,30	S7D05	180 [7.1]	165 [6.5]	185 [7.3]	176 [6.9]	94 [3.7]	14 [30.9]
-140-...-A	-112-...-NA-A	0.26	107	160	50/60	LR3-107-160-0,26	S7D06	180 [7.1]	165 [6.5]	190 [7.5]	176 [6.9]	94 [3.7]	15 [33.1]
-185-...-A	-148-...-NA-A	0.17	163	244	50/60	LR3-163-244-0,17	S7D07	240 [9.4]	216 [9.3]	240 [9.4]	176 [6.9]	109 [4.3]	27 [59.5]
-280-...-B	-224-...-NA-B	0.11	253	380	50/60	LR3-253-380-0,11	S7D09	300 [11.8]	265 [10.4]	230 [9.1]	224 [8.8]	117 [4.6]	34 [74.9]
-350-...-B	-280-...-NA-B	0.1	287	430	50/60	LR3-287-430-0,1	S7D10	300 [11.8]	265 [10.4]	250 [9.8]	224 [8.8]	127 [5.0]	40 [88.2]
-420-...-B	-336-...-NA-B	0.076	368	552	50/60	LR3-368-552-0,076	S7D11	300 [11.8]	270 [10.6]	280 [11.0]	224 [8.8]	127 [5.0]	47 [103.6]
-500-...-B	-400-...-NA-B	0.06	458	687	50/60	LR3-458-687-0,06	S7D12	300 [11.8]	265 [10.4]	320 [12.6]	250 [9.8]	134 [5.3]	56 [123.4]
-650-...-B	-450-...-NA-B	0.05	605	910	50/60	LR3-605-910-0,05	S7D27	380 [14.9]	415 [16.3]	220 [8.6]	250 [9.8]	133 [5.2]	78 [171.9]
-770-...-C	-560-...-NA-C	0.04	685	1027	50/60	LR3-685-1027-0,04	S7D14	386 [15.2]	410 [16.1]	270 [10.6]	300 [11.8]	149 [5.9]	77 [169.7]
-1000-...-C	-800-...-NA-C	0.03	869	1303	50/60	LR3-869-1303-0,03	S7D15	420 [16.5]	495 [19.5]	270 [10.6]	320 [12.6]	149 [5.9]	110 [242.5]
-1050-...-C	-850-...-NA-C	0.03	869	1303	50/60	LR3-869-1303-0,03	S7D15	420 [16.5]	495 [19.5]	270 [10.6]	320 [12.6]	149 [5.9]	110 [242.5]
-1200-...-D		0.024	1143	1714	50/60	LR3-1143-1714-0,024	S7D16	420 [16.5]	485 [19.1]	280 [11.0]	355 [14]	145 [5.7]	140 [308.6]
-1500-...-D		0.019	1425	2138	50/60	LR3-1425-2138-0,019	S7D17	460 [18.1]	520 [20.5]	340 [13.4]	400 [15.7]	230 [9.1]	150 [330.7]
-1600-...-D		0.019	1425	2138	50/60	LR3-1425-2138-0,019	S7D17	460 [18.1]	520 [20.5]	340 [13.4]	400 [15.7]	230 [9.1]	150 [330.7]
-1700-...-D		0.019	1425	2138	50/60	LR3-1425-2138-0,019	S7D17	460 [18.1]	520 [20.5]	340 [13.4]	400 [15.7]	230 [9.1]	150 [330.7]
-1800-...-D		0.016	1712	2568	50/60	LR3-1712-2568-0,016	S7D18	430 [16.9]	525 [20.7]	320 [12.6]	355 [14]	155 [6.1]	160 [352.7]
-2000-...-D		0.016	1712	2568	50/60	LR3-1712-2568-0,016	S7D18	430 [16.9]	525 [20.7]	320 [12.6]	355 [14]	155 [6.1]	160 [352.7]

EMC Filters

Filtri EMC
Filtres EMC
EMV-Filter
Filtros EMC



The converters of TPD32 EV series must be equipped with an external EMI filter in order to reduce the radiofrequency emissions on the mains line. The filter selection is depending on the drive size and the installation environment. For this purpose see the "EMC Guidelines".

TPD32-EV-FC-...: reference should be made to the corresponding voltage and current sizes.



I convertitori della serie TPD32 EV devono essere equipaggiati esternamente con un filtro EMI al fine di limitare le emissioni in radiofrequenza verso rete. La selezione di tale filtro viene effettuata in funzione della taglia del convertitore e dell'ambiente di installazione. A tale scopo si veda la Guida alla compatibilità elettromagnetica allegata all'apparecchio.

TPD32-EV-FC-...: fare riferimento alle corrispondenti taglie in tensione e corrente.



Les variateurs de la série TPD32 EV doivent être équipés en externe d'un filtre RFI dans le but de réduire les radioperturbations envoyées vers le réseau. Le choix d'un tel filtre est effectué en fonction de la taille du variateur et des conditions d'environnement. Pour ce choix il faut se référer au guide de compatibilité CEM fourni avec l'appareil.

TPD32-EV-FC-...: faire référence aux grandeurs correspondantes en tension et courant.



Die Stromrichter der Reihe TPD32 EV müssen extern mit einem EMV Filtern ausgestattet sein, um die Netzfunkestörungen zu begrenzen. Der Filter wird anhand der Größe des Stromrichters und dem Montageort ausgewählt. Lesen Sie bitte dazu die dem Gerät beigelegte EMV Richtlinie.

TPD32-EV-FC-...: siehe die entsprechenden Spannungs- und Stromgrößen.



Los convertidores de la serie TPD32 EV están equipados externamente con un filtro EMI con el objeto de limitar la emisión de radiofrecuencia hacia la red. La selección de dicho filtro se efectúa en función de la talla del convertidor y del ambiente de instalación. Para mayor información véase la guía de la compatibilidad electromagnética adjunta al aparato.

TPD32-EV-FC-...: consulte los tamaños correspondientes de tensión y corriente.



European Drive Rating (2B)	European Drive Rating (4B)	Filter type	Filter code	Category / Environment / Motor cable length (max)
AC mains voltage 230V - 400V ±10%				
TPD32-EV-500/600-20-2B-A	TPD32-EV-500/520-20-4B-A	EMI-FTF-480-42	S7G0A	C3 / 2nd / 30 m
TPD32-EV-500/600-40-2B-A	TPD32-EV-500/520-40-4B-A	EMI-FTF-480-42	S7G0A	C3 / 2nd / 30 m
TPD32-EV-500/600-70-2B-A	TPD32-EV-500/520-70-4B-A	EMI-FTF-480-75	S7G0C	C3 / 2nd / 30 m
TPD32-EV-500/600-110-2B-A	TPD32-EV-500/520-110-4B-A	EMI-FTF-480-100	S7G0D	C3 / 2nd / 30 m
TPD32-EV-500/600-140-2B-A	TPD32-EV-500/520-140-4B-A	EMI-FTF-480-130	S7G0E	C3 / 2nd / 30 m
TPD32-EV-500/600-185-2B-A	TPD32-EV-500/520-185-4B-A	EMI-FTF-480-130	S7G0E	C3 / 2nd / 30 m
TPD32-EV-500/600-280-2B-B	TPD32-EV-500/520-280-4B-B	EMI-480-320	S7DGH	C3 / 2nd / 100 m
TPD32-EV-500/600-350-2B-B	TPD32-EV-500/520-350-4B-B	EMI-480-400	S7DGI	C3 / 2nd / 100 m
TPD32-EV-500/600-420-2B-B	TPD32-EV-500/520-420-4B-B	EMI-480-400	S7DGI	C3 / 2nd / 100 m
TPD32-EV-500/600-500-2B-B	TPD32-EV-500/520-500-4B-B	EMI-480-600	S7DGL	C3 / 2nd / 100 m
TPD32-EV-500/600-650-2B-B	TPD32-EV-500/520-650-4B-B	EMI-480-600	S7DGL	C3 / 2nd / 100 m
TPD32-EV-500/600-770-2B-C	TPD32-EV-500/520-770-4B-C	EMI-480-800	S7DGM	C3 / 2nd / 100 m
TPD32-EV-500/600-1000-2B-C	TPD32-EV-500/520-1050-4B-C	EMI-480-1000	S7DGN	C3 / 2nd / 100 m
TPD32-EV-500/600-1400-2B-D	TPD32-EV-500/520-1400-4B-D	EMI-690-1600	S7DGK	C3 / 2nd / 100 m
TPD32-EV-500/600-1600-2B-D	TPD32-EV-500/520-1600-4B-D	EMI-690-1600	S7DGK	C3 / 2nd / 100 m
TPD32-EV-500/600-2000-2B-D	TPD32-EV-500/520-2000-4B-D	EMI-FN-3359-480-2500	S7EMIS	C3 / 2nd / 100 m
TPD32-EV-500/600-2400-2B-D	TPD32-EV-500/520-2400-4B-D	EMI-FN-3359-480-2500	S7EMIS	C3 / 2nd / 100 m
TPD32-EV-500/600-1200-2B-E	-----	EMI-690-1600	S7DGK	C3 / 2nd / 100 m
TPD32-EV-500/600-1500-2B-E	TPD32-EV-500/520-1500-4B-E	EMI-690-1600	S7DGK	C3 / 2nd / 100 m
TPD32-EV-500/600-1800-2B-E	TPD32-EV-500/520-1700-4B-E	EMI-FN-3359-480-2500	S7EMIS	C3 / 2nd / 100 m
TPD32-EV-500/600-2000-2B-E	TPD32-EV-500/520-2000-4B-E	EMI-FN-3359-480-2500	S7EMIS	C3 / 2nd / 100 m
TPD32-EV-500/600-2400-2B-E	TPD32-EV-500/520-2400-4B-E	EMI-FN-3359-480-2500	S7EMIS	C3 / 2nd / 100 m
TPD32-EV-500/600-2700-2B-E	TPD32-EV-500/520-2700-4B-E	EMI-FN-3359-480-2500	S7EMIS	C3 / 2nd / 100 m
TPD32-EV-500/600-2900-2B-E	-----	n.a.		
TPD32-EV-500/600-3300-2B-E	TPD32-EV-500/520-3300-4B-E	n.a.		
AC mains voltage 480V ±10%				
TPD32-EV-500/600-20-2B-A	TPD32-EV-500/520-20-4B-A	EMI-FTF-480-42	S7G0A	C3 / 2nd / 30 m
TPD32-EV-500/600-40-2B-A	TPD32-EV-500/520-40-4B-A	EMI-FTF-480-42	S7G0A	C3 / 2nd / 30 m
TPD32-EV-500/600-70-2B-A	TPD32-EV-500/520-70-4B-A	EMI-FTF-480-75	S7G0C	C3 / 2nd / 30 m
TPD32-EV-500/600-110-2B-A	TPD32-EV-500/520-110-4B-A	EMI-FTF-480-100	S7G0D	C3 / 2nd / 30 m
TPD32-EV-500/600-140-2B-A	TPD32-EV-500/520-140-4B-A	EMI-FTF-480-130	S7G0E	C3 / 2nd / 30 m
TPD32-EV-500/600-185-2B-A	TPD32-EV-500/520-185-4B-A	EMI-FTF-480-130	S7G0E	C3 / 2nd / 30 m
TPD32-EV-500/600-280-2B-B	TPD32-EV-500/520-280-4B-B	EMI-480-320	S7DGH	C3 / 2nd / 100 m
TPD32-EV-500/600-350-2B-B	TPD32-EV-500/520-350-4B-B	EMI-480-400	S7DGI	C3 / 2nd / 100 m
TPD32-EV-500/600-420-2B-B	TPD32-EV-500/520-420-4B-B	EMI-480-400	S7DGI	C3 / 2nd / 100 m
TPD32-EV-500/600-500-2B-B	TPD32-EV-500/520-500-4B-B	EMI-480-600	S7DGL	C3 / 2nd / 100 m
TPD32-EV-500/600-650-2B-B	TPD32-EV-500/520-650-4B-B	EMI-480-800	S7DGM	C3 / 2nd / 100 m

European Drive Rating (2B)	European Drive Rating (4B)	Filter type	Filter code	Category / Environment / Motor cable length (max)
TPD32-EV-500/600-770-2B-C	TPD32-EV-500/520-770-4B-C	EMI-480-800	S7DGM	C3 / 2nd / 100 m
TPD32-EV-500/600-1000-2B-C	TPD32-EV-500/520-1050-4B-C	EMI-480-1000	S7DGN	C3 / 2nd / 100 m
TPD32-EV-500/600-1400-2B-D	TPD32-EV-500/520-1400-4B-D	EMI-690-1600	S7DGK	C3 / 2nd / 100 m
TPD32-EV-500/600-1600-2B-D	TPD32-EV-500/520-1600-4B-D	EMI-690-1600	S7DGK	C3 / 2nd / 100 m
TPD32-EV-500/600-2000-2B-D	TPD32-EV-500/520-2000-4B-D	EMI-FN-3359-480-2500	S7EMIS	C3 / 2nd / 100 m
TPD32-EV-500/600-2400-2B-D	TPD32-EV-500/520-2400-4B-D	EMI-FN-3359-480-2500	S7EMIS	C3 / 2nd / 100 m
TPD32-EV-500/600-1200-2B-E	-----	EMI-690-1600	S7DGK	C3 / 2nd / 100 m
TPD32-EV-500/600-1500-2B-E	TPD32-EV-500/520-1500-4B-E	EMI-690-1600	S7DGK	C3 / 2nd / 100 m
TPD32-EV-500/600-1800-2B-E	TPD32-EV-500/520-1700-4B-E	EMI-FN-3359-480-2500	S7EMIS	C3 / 2nd / 100 m
TPD32-EV-500/600-2000-2B-E	TPD32-EV-500/520-2000-4B-E	EMI-FN-3359-480-2500	S7EMIS	C3 / 2nd / 100 m
TPD32-EV-500/600-2400-2B-E	TPD32-EV-500/520-2400-4B-E	EMI-FN-3359-480-2500	S7EMIS	C3 / 2nd / 100 m
TPD32-EV-500/600-2700-2B-E	TPD32-EV-500/520-2700-4B-E	EMI-FN-3359-480-2500	S7EMIS	C3 / 2nd / 100 m
TPD32-EV-500/600-2900-2B-E	-----	n.a.		
TPD32-EV-500/600-3300-2B-E	TPD32-EV-500/520-3300-4B-E	n.a.		
AC mains voltage 500V ±10%				
TPD32-EV-500/600-20-2B-A	TPD32-EV-500/520-20-4B-A	EMI-FTF-480-42	S7GOA	C3 / 2nd / 30 m
TPD32-EV-500/600-40-2B-A	TPD32-EV-500/520-40-4B-A	EMI-FTF-480-42	S7GOA	C3 / 2nd / 30 m
TPD32-EV-500/600-70-2B-A	TPD32-EV-500/520-70-4B-A	EMI-FTF-480-75	S7GOC	C3 / 2nd / 30 m
TPD32-EV-500/600-110-2B-A	TPD32-EV-500/520-110-4B-A	EMI-FTF-480-100	S7GOD	C3 / 2nd / 30 m
TPD32-EV-500/600-140-2B-A	TPD32-EV-500/520-140-4B-A	EMI-FTF-480-130	S7GOE	C3 / 2nd / 30 m
TPD32-EV-500/600-185-2B-A	TPD32-EV-500/520-185-4B-A	EMI-FTF-480-130	S7GOE	C3 / 2nd / 30 m
TPD32-EV-500/600-280-2B-B	TPD32-EV-500/520-280-4B-B	EMI-480-320	S7DGH	C3 / 2nd / 100 m
TPD32-EV-500/600-350-2B-B	TPD32-EV-500/520-350-4B-B	EMI-480-400	S7DGI	C3 / 2nd / 100 m
TPD32-EV-500/600-420-2B-B	TPD32-EV-500/520-420-4B-B	EMI-480-400	S7DGI	C3 / 2nd / 100 m
TPD32-EV-500/600-500-2B-B	TPD32-EV-500/520-500-4B-B	EMI-480-600	S7DGL	C3 / 2nd / 100 m
TPD32-EV-500/600-650-2B-B	TPD32-EV-500/520-650-4B-B	EMI-480-800	S7DGM	C3 / 2nd / 100 m
TPD32-EV-500/600-770-2B-C	TPD32-EV-500/520-770-4B-C	EMI-480-800	S7DGM	C3 / 2nd / 100 m
TPD32-EV-500/600-1000-2B-C	TPD32-EV-500/520-1050-4B-C	EMI-480-1000	S7DGN	C3 / 2nd / 100 m
TPD32-EV-500/600-1400-2B-D	TPD32-EV-500/520-1400-4B-D	EMI-690-1600	S7DGK	C3 / 2nd / 100 m
TPD32-EV-500/600-1600-2B-D	TPD32-EV-500/520-1600-4B-D	EMI-690-1600	S7DGK	C3 / 2nd / 100 m
TPD32-EV-500/600-2000-2B-D	TPD32-EV-500/520-2000-4B-D	Schaffner FN 3359HV-2500-99 or TDK-EPCOS B84143B2500S024		C3 / 2nd / 100 m
TPD32-EV-500/600-2400-2B-D	TPD32-EV-500/520-2400-4B-D			
TPD32-EV-500/600-1200-2B-E	-----	EMI-690-1600	S7DGK	C3 / 2nd / 100 m
TPD32-EV-500/600-1500-2B-E	TPD32-EV-500/520-1500-4B-E	EMI-690-1600	S7DGK	C3 / 2nd / 100 m
TPD32-EV-500/600-1800-2B-E	TPD32-EV-500/520-1700-4B-E			
TPD32-EV-500/600-2000-2B-E	TPD32-EV-500/520-2000-4B-E	Schaffner FN 3359HV-2500-99 or TDK-EPCOS B84143B2500S024		C3 / 2nd / 100 m
TPD32-EV-500/600-2400-2B-E	TPD32-EV-500/520-2400-4B-E			
TPD32-EV-500/600-2700-2B-E	TPD32-EV-500/520-2700-4B-E			
TPD32-EV-500/600-2900-2B-E	-----	n.a.		
TPD32-EV-500/600-3300-2B-E	TPD32-EV-500/520-3300-4B-E	n.a.		
AC mains voltage 575V ±10%				
TPD32-EV-575/680-280-2B-B	TPD32-EV-575/600-280-4B-B	EMI-690-320	S7DGR	C3 / 2nd / 100 m
TPD32-EV-575/680-350-2B-B	TPD32-EV-575/600-350-4B-B	EMI-690-400	S7EMI12	C3 / 2nd / 100 m
TPD32-EV-575/680-420-2B-B	TPD32-EV-575/600-420-4B-B	EMI-690-400	S7EMI12	C3 / 2nd / 100 m
TPD32-EV-575/680-500-2B-B	TPD32-EV-575/600-500-4B-B	EMI-690-600	S7DGS	C3 / 2nd / 100 m
TPD32-EV-575/680-650-2B-B	TPD32-EV-575/600-650-4B-B	EMI-690-600	S6DGS	C3 / 2nd / 100 m
TPD32-EV-575/680-700-2B-C	TPD32-EV-575/600-700-4B-C	EMI-690-1600	S7DGK	C3 / 2nd / 100 m
TPD32-EV-575/680-1000-2B-C	TPD32-EV-575/600-1050-4B-C	EMI-690-1600	S7DGK	C3 / 2nd / 100 m
TPD32-EV-575/680-1300-2B-D	TPD32-EV-575/600-1300-4B-D	EMI-690-1600	S7DGK	C3 / 2nd / 100 m
TPD32-EV-575/680-1600-2B-D	TPD32-EV-575/600-1600-4B-D	EMI-690-1600	S7DGK	C3 / 2nd / 100 m
TPD32-EV-575/680-2000-2B-D	TPD32-EV-575/600-2000-4B-D	Schaffner FN 3359HV-2500-99 or TDK-EPCOS B84143B2500S024		C3 / 2nd / 100 m
TPD32-EV-575/680-2300-2B-D	TPD32-EV-575/600-2300-4B-D			

European Drive Rating (2B)	European Drive Rating (4B)	Filter type	Filter code	Category / Environment / Motor cable length (max)
AC mains voltage 690V ±10%				
TPD32-EV-690/810-560-2B-C	TPD32-EV-690/720-560-4B-C	EMI-690-600	S7DGS	C3 / 2nd / 100 m
TPD32-EV-690/810-700-2B-C	TPD32-EV-690/720-700-4B-C	EMI-690-1600	S7DGK	C3 / 2nd / 100 m
TPD32-EV-690/810-900-2B-C	TPD32-EV-690/720-900-4B-C	EMI-690-1600	S7DGK	C3 / 2nd / 100 m
TPD32-EV-690/810-1300-2B-D	TPD32-EV-690/720-1300-4B-D	EMI-690-1600	S7DGK	C3 / 2nd / 100 m
TPD32-EV-690/810-1600-2B-D	TPD32-EV-690/720-1600-4B-D	EMI-690-1600	S7DGK	C3 / 2nd / 100 m
TPD32-EV-690/810-1900-2B-D	TPD32-EV-690/720-1900-4B-D	TDK-EPCOS B84143B2500S021		C3 / 2nd / 100 m
TPD32-EV-690/810-2100-2B-D	TPD32-EV-690/720-2100-4B-D			
TPD32-EV-690/810-1010-2B-E	TPD32-EV-690/720-1010-4B-E	EMI-690-1600	S7DGK	C3 / 2nd / 100 m
TPD32-EV-690/810-1400-2B-E	TPD32-EV-690/720-1400-4B-E	EMI-690-1600	S7DGK	C3 / 2nd / 100 m
TPD32-EV-690/810-1700-2B-E	TPD32-EV-690/720-1700-4B-E			
TPD32-EV-690/810-2000-2B-E	TPD32-EV-690/720-2000-4B-E	TDK-EPCOS B84143B2500S021		C3 / 2nd / 100 m
TPD32-EV-690/810-2400-2B-E	TPD32-EV-690/720-2400-4B-E			
TPD32-EV-690/810-2700-2B-E	TPD32-EV-690/720-2700-4B-E			
TPD32-EV-690/810-3300-2B-E	TPD32-EV-690/720-3300-4B-E	n.a.		

GEFIRAN

نماینده رسمی جفران ایتالیا در ایران

American Drive Rating (2B)	American Drive Rating (4B)	Filter type	Filter code	Category / Environment / Motor cable length (max)
AC mains voltage 230V - 400V ±10%				
TPD32-EV-500/600-17-2B-A-NA	TPD32-EV-500/520-17-4B-A-NA	EMI-FTF-480-42	S7G0A	C3 / 2nd / 30 m
TPD32-EV-500/600-35-2B-A-NA	TPD32-EV-500/520-35-4B-A-NA	EMI-FTF-480-42	S7G0A	C3 / 2nd / 30 m
TPD32-EV-500/600-56-2B-A-NA	TPD32-EV-500/520-56-4B-A-NA	EMI-FTF-480-75	S7G0C	C3 / 2nd / 30 m
TPD32-EV-500/600-88-2B-A-NA	TPD32-EV-500/520-88-4B-A-NA	EMI-FTF-480-130	S7G0E	C3 / 2nd / 30 m
TPD32-EV-500/600-112-2B-A-NA	TPD32-EV-500/520-112-4B-A-NA	EMI-FTF-480-130	S7G0E	C3 / 2nd / 30 m
TPD32-EV-500/600-148-2B-A-NA	TPD32-EV-500/520-148-4B-A-NA	EMI-FTF-480-180	S7G0F	C3 / 2nd / 30 m
TPD32-EV-500/600-224-2B-B-NA	TPD32-EV-500/520-224-4B-B-NA	EMI-480-320	S7DGH	C3 / 2nd / 100 m
TPD32-EV-500/600-280-2B-B-NA	TPD32-EV-500/520-280-4B-B-NA	EMI-480-400	S7DGI	C3 / 2nd / 100 m
TPD32-EV-500/600-336-2B-B-NA	TPD32-EV-500/520-336-4B-B-NA	EMI-480-400	S7DGI	C3 / 2nd / 100 m
TPD32-EV-500/600-400-2B-B-NA	TPD32-EV-500/520-400-4B-B-NA	EMI-480-600	S7DGL	C3 / 2nd / 100 m
TPD32-EV-500/600-450-2B-B-NA	TPD32-EV-500/520-450-4B-B-NA	EMI-480-600	S7DGL	C3 / 2nd / 100 m
TPD32-EV-500/600-560-2B-C-NA	TPD32-EV-500/520-560-4B-C-NA	EMI-480-800	S7DGM	C3 / 2nd / 100 m
TPD32-EV-500/600-800-2B-C-NA	TPD32-EV-500/520-850-4B-C-NA	EMI-480-1000	S7DGN	C3 / 2nd / 100 m
TPD32-EV-500/600-1000-2B-D-NA	TPD32-EV-500/520-1000-4B-D-NA	EMI-690-1600	S7DGK	C3 / 2nd / 100 m
TPD32-EV-500/600-1200-2B-D-NA	TPD32-EV-500/520-1200-4B-D-NA	EMI-690-1600	S7DGK	C3 / 2nd / 100 m
TPD32-EV-500/600-1500-2B-D-NA	TPD32-EV-500/520-1500-4B-D-NA	EMI-FN-3359-480-2500	S7EMIS	C3 / 2nd / 100 m
TPD32-EV-500/600-1850-2B-D-NA	TPD32-EV-500/520-1850-4B-D-NA	EMI-FN-3359-480-2500	S7EMIS	C3 / 2nd / 100 m
TPD32-EV-500/600-1000-2B-E-NA	-----	EMI-690-1600	S7DGK	C3 / 2nd / 100 m
TPD32-EV-500/600-1300-2B-E-NA	TPD32-EV-500/520-1300-4B-E-NA	EMI-690-1600	S7DGK	C3 / 2nd / 100 m
TPD32-EV-500/600-1400-2B-E-NA	TPD32-EV-500/520-1350-4B-E-NA	EMI-FN-3359-480-2500	S7EMIS	C3 / 2nd / 100 m
TPD32-EV-500/600-1500-2B-E-NA	TPD32-EV-500/520-1500-4B-E-NA	EMI-FN-3359-480-2500	S7EMIS	C3 / 2nd / 100 m
TPD32-EV-500/600-1800-2B-E-NA	TPD32-EV-500/520-1800-4B-E-NA	EMI-FN-3359-480-2500	S7EMIS	C3 / 2nd / 100 m
TPD32-EV-500/600-2000-2B-E-NA	TPD32-EV-500/520-2000-4B-E-NA	EMI-FN-3359-480-2500	S7EMIS	C3 / 2nd / 100 m
TPD32-EV-500/600-2200-2B-E-NA	-----	n.a.		
TPD32-EV-500/600-2350-2B-E-NA	TPD32-EV-500/520-2350-4B-E-NA	n.a.		
AC mains voltage 480V ±10%				
TPD32-EV-500/600-17-2B-A-NA	TPD32-EV-500/520-17-4B-A-NA	EMI-FTF-480-42	S7G0A	C3 / 2nd / 30 m
TPD32-EV-500/600-35-2B-A-NA	TPD32-EV-500/520-35-4B-A-NA	EMI-FTF-480-42	S7G0A	C3 / 2nd / 30 m
TPD32-EV-500/600-56-2B-A-NA	TPD32-EV-500/520-56-4B-A-NA	EMI-FTF-480-75	S7G0C	C3 / 2nd / 30 m
TPD32-EV-500/600-88-2B-A-NA	TPD32-EV-500/520-88-4B-A-NA	EMI-FTF-480-130	S7G0E	C3 / 2nd / 30 m
TPD32-EV-500/600-112-2B-A-NA	TPD32-EV-500/520-112-4B-A-NA	EMI-FTF-480-130	S7G0E	C3 / 2nd / 30 m
TPD32-EV-500/600-148-2B-A-NA	TPD32-EV-500/520-148-4B-A-NA	EMI-FTF-480-180	S7G0F	C3 / 2nd / 30 m
TPD32-EV-500/600-224-2B-B-NA	TPD32-EV-500/520-224-4B-B-NA	EMI-480-320	S7DGH	C3 / 2nd / 100 m
TPD32-EV-500/600-280-2B-B-NA	TPD32-EV-500/520-280-4B-B-NA	EMI-480-400	S7DGI	C3 / 2nd / 100 m
TPD32-EV-500/600-336-2B-B-NA	TPD32-EV-500/520-336-4B-B-NA	EMI-480-400	S7DGI	C3 / 2nd / 100 m
TPD32-EV-500/600-400-2B-B-NA	TPD32-EV-500/520-400-4B-B-NA	EMI-480-600	S7DGL	C3 / 2nd / 100 m
TPD32-EV-500/600-450-2B-B-NA	TPD32-EV-500/520-450-4B-B-NA	EMI-480-600	S7DGL	C3 / 2nd / 100 m
TPD32-EV-500/600-560-2B-C-NA	TPD32-EV-500/520-560-4B-C-NA	EMI-480-800	S7DGM	C3 / 2nd / 100 m
TPD32-EV-500/600-800-2B-C-NA	TPD32-EV-500/520-850-4B-C-NA	EMI-480-1000	S7DGN	C3 / 2nd / 100 m
TPD32-EV-500/600-1000-2B-D-NA	TPD32-EV-500/520-1000-4B-D-NA	EMI-690-1600	S7DGK	C3 / 2nd / 100 m
TPD32-EV-500/600-1200-2B-D-NA	TPD32-EV-500/520-1200-4B-D-NA	EMI-690-1600	S7DGK	C3 / 2nd / 100 m
TPD32-EV-500/600-1500-2B-D-NA	TPD32-EV-500/520-1500-4B-D-NA	EMI-FN-3359-480-2500	S7EMIS	C3 / 2nd / 100 m
TPD32-EV-500/600-1850-2B-D-NA	TPD32-EV-500/520-1850-4B-D-NA	EMI-FN-3359-480-2500	S7EMIS	C3 / 2nd / 100 m
TPD32-EV-500/600-1000-2B-E-NA	-----	EMI-690-1600	S7DGK	C3 / 2nd / 100 m
TPD32-EV-500/600-1300-2B-E-NA	TPD32-EV-500/520-1300-4B-E-NA	EMI-690-1600	S7DGK	C3 / 2nd / 100 m
TPD32-EV-500/600-1400-2B-E-NA	TPD32-EV-500/520-1350-4B-E-NA	EMI-FN-3359-480-2500	S7EMIS	C3 / 2nd / 100 m
TPD32-EV-500/600-1500-2B-E-NA	TPD32-EV-500/520-1500-4B-E-NA	EMI-FN-3359-480-2500	S7EMIS	C3 / 2nd / 100 m
TPD32-EV-500/600-1800-2B-E-NA	TPD32-EV-500/520-1800-4B-E-NA	EMI-FN-3359-480-2500	S7EMIS	C3 / 2nd / 100 m
TPD32-EV-500/600-2000-2B-E-NA	TPD32-EV-500/520-2000-4B-E-NA	EMI-FN-3359-480-2500	S7EMIS	C3 / 2nd / 100 m
TPD32-EV-500/600-2200-2B-E-NA	-----	n.a.		
TPD32-EV-500/600-2350-2B-E-NA	TPD32-EV-500/520-2350-4B-E-NA	n.a.		

American Drive Rating (2B)	American Drive Rating (4B)	Filter type	Filter code	Category / Environment / Motor cable length (max)
AC mains voltage 500V ±10%				
TPD32-EV-500/600-17-2B-A-NA	TPD32-EV-500/520-17-4B-A-NA	EMI-600-34	S7DFM	C3 / 2nd / 30 m
TPD32-EV-500/600-35-2B-A-NA	TPD32-EV-500/520-35-4B-A-NA	EMI-600-62	S7DFO	C3 / 2nd / 30 m
TPD32-EV-500/600-56-2B-A-NA	TPD32-EV-500/520-56-4B-A-NA	EMI-600-85	S7DFP	C3 / 2nd / 30 m
TPD32-EV-500/600-88-2B-A-NA	TPD32-EV-500/520-88-4B-A-NA	EMI-600-113	S7DFQ	C3 / 2nd / 30 m
TPD32-EV-500/600-112-2B-A-NA	TPD32-EV-500/520-112-4B-A-NA	EMI-600-145	S7DFR	C3 / 2nd / 30 m
TPD32-EV-500/600-148-2B-A-NA	TPD32-EV-500/520-148-4B-A-NA	EMI-SCHF-600-205	S7DGD	C3 / 2nd / 30 m
TPD32-EV-500/600-224-2B-B-NA	TPD32-EV-500/520-224-4B-B-NA	EMI-690-320	S7DGR	C3 / 2nd / 100 m
TPD32-EV-500/600-280-2B-B-NA	TPD32-EV-500/520-280-4B-B-NA	EMI-690-400	S7EMI12	C3 / 2nd / 100 m
TPD32-EV-500/600-336-2B-B-NA	TPD32-EV-500/520-336-4B-B-NA	EMI-690-400	S7EMI12	C3 / 2nd / 100 m
TPD32-EV-500/600-400-2B-B-NA	TPD32-EV-500/520-400-4B-B-NA	EMI-690-600	S7DGS	C3 / 2nd / 100 m
TPD32-EV-500/600-450-2B-B-NA	TPD32-EV-500/520-450-4B-B-NA	EMI-690-600	S7DGS	C3 / 2nd / 100 m
TPD32-EV-500/600-560-2B-C-NA	TPD32-EV-500/520-560-4B-C-NA	EMI-690-1600	S7DGK	C3 / 2nd / 100 m
TPD32-EV-500/600-800-2B-C-NA	TPD32-EV-500/520-850-4B-C-NA	EMI-690-1600	S7DGK	C3 / 2nd / 100 m
TPD32-EV-500/600-1000-2B-D-NA	TPD32-EV-500/520-1000-4B-D-NA	EMI-690-1600	S7DGK	C3 / 2nd / 100 m
TPD32-EV-500/600-1200-2B-D-NA	TPD32-EV-500/520-1200-4B-D-NA	EMI-690-1600	S7DGK	C3 / 2nd / 100 m
TPD32-EV-500/600-1500-2B-D-NA	TPD32-EV-500/520-1500-4B-D-NA	Schaffner FN 3359HV-2500-99 or TDK-EPCOS B84143B2500S024		C3 / 2nd / 100 m
TPD32-EV-500/600-1850-2B-D-NA	TPD32-EV-500/520-1850-4B-D-NA			C3 / 2nd / 100 m
TPD32-EV-500/600-1000-2B-E-NA	-----	EMI-690-1600	S7DGK	C3 / 2nd / 100 m
TPD32-EV-500/600-1300-2B-E-NA	TPD32-EV-500/520-1300-4B-E-NA	EMI-690-1600	S7DGK	C3 / 2nd / 100 m
TPD32-EV-500/600-1400-2B-E-NA	TPD32-EV-500/520-1350-4B-E-NA			
TPD32-EV-500/600-1500-2B-E-NA	TPD32-EV-500/520-1500-4B-E-NA	Schaffner FN 3359HV-2500-99 or TDK-EPCOS B84143B2500S024		C3 / 2nd / 100 m
TPD32-EV-500/600-1800-2B-E-NA	TPD32-EV-500/520-1800-4B-E-NA			
TPD32-EV-500/600-2000-2B-E-NA	TPD32-EV-500/520-2000-4B-E-NA			
TPD32-EV-500/600-2200-2B-E-NA	-----	n.a.		
TPD32-EV-500/600-2350-2B-E-NA	TPD32-EV-500/520-2350-4B-E-NA	n.a.		
AC mains voltage 575 ±10%				
TPD32-EV-575/680-224-2B-B-NA	TPD32-EV-575/600-224-4B-B-NA	EMI-690-320	S7DGR	C3 / 2nd / 100 m
TPD32-EV-575/680-280-2B-B-NA	TPD32-EV-575/600-280-4B-B-NA	EMI-690-400	S7EMI12	C3 / 2nd / 100 m
TPD32-EV-575/680-336-2B-B-NA	TPD32-EV-575/600-336-4B-B-NA	EMI-690-600	S7DGS	C3 / 2nd / 100 m
TPD32-EV-575/680-400-2B-B-NA	TPD32-EV-575/600-400-4B-B-NA	EMI-690-600	S7DGS	C3 / 2nd / 100 m
TPD32-EV-575/680-450-2B-B-NA	TPD32-EV-575/600-450-4B-B-NA	EMI-690-600	S7DGS	C3 / 2nd / 100 m
TPD32-EV-575/680-490-2B-C-NA	TPD32-EV-575/600-490-4B-C-NA	EMI-690-600	S7DGS	C3 / 2nd / 100 m
TPD32-EV-575/680-750-2B-C-NA	TPD32-EV-575/600-750-4B-C-NA	EMI-690-1600	S7DGK	C3 / 2nd / 100 m
TPD32-EV-575/680-980-2B-D-NA	TPD32-EV-575/600-980-4B-D-NA	EMI-690-1600	S7DGK	C3 / 2nd / 100 m
TPD32-EV-575/680-1200-2B-D-NA	TPD32-EV-575/600-1200-4B-D-NA	EMI-690-1600	S7DGK	C3 / 2nd / 100 m
TPD32-EV-575/680-1500-2B-D-NA	TPD32-EV-575/600-1500-4B-D-NA	Schaffner FN 3359HV-2500-99 or TDK-EPCOS B84143B2500S024		C3 / 2nd / 100 m
TPD32-EV-575/680-1800-2B-D-NA	TPD32-EV-575/600-1800-4B-D-NA			
AC mains voltage 690V ±10%				
TPD32-EV-690/810-360-2B-C-NA	TPD32-EV-690/720-360-4B-C-NA	EMI-690-600	S7DGS	C3 / 2nd / 100 m
TPD32-EV-690/810-490-2B-C-NA	TPD32-EV-690/720-490-4B-C-NA	EMI-690-600	S7DGS	C3 / 2nd / 100 m
TPD32-EV-690/810-650-2B-C-NA	TPD32-EV-690/720-650-4B-C-NA	EMI-690-1600	S7DGK	C3 / 2nd / 100 m
TPD32-EV-690/810-920-2B-D-NA	TPD32-EV-690/720-980-4B-D-NA	EMI-690-1600	S7DGK	C3 / 2nd / 100 m
TPD32-EV-690/810-1200-2B-D-NA	TPD32-EV-690/720-1200-4B-D-NA	EMI-690-1600	S7DGK	C3 / 2nd / 100 m
TPD32-EV-690/810-1450-2B-D-NA	TPD32-EV-690/720-1450-4B-D-NA	TDK-EPCOS B84143B2500S021		C3 / 2nd / 100 m
TPD32-EV-690/810-1650-2B-D-NA	TPD32-EV-690/720-1650-4B-D-NA			C3 / 2nd / 100 m
TPD32-EV-690/810-900-2B-E-NA	TPD32-EV-690/720-900-4B-E-NA	EMI-690-1600	S7DGK	C3 / 2nd / 100 m
TPD32-EV-690/810-1150-2B-E-NA	TPD32-EV-690/720-1150-4B-E-NA	EMI-690-1600	S7DGK	C3 / 2nd / 100 m
TPD32-EV-690/810-1350-2B-E-NA	TPD32-EV-690/720-1350-4B-E-NA			
TPD32-EV-690/810-1500-2B-E-NA	TPD32-EV-690/720-1500-4B-E-NA	TDK-EPCOS B84143B2500S021		C3 / 2nd / 100 m
TPD32-EV-690/810-1800-2B-E-NA	TPD32-EV-690/720-1800-4B-E-NA			
TPD32-EV-690/810-2000-2B-E-NA	TPD32-EV-690/720-2000-4B-E-NA			
TPD32-EV-690/810-2350-2B-E-NA	TPD32-EV-690/720-2350-4B-E-NA	n.a.		

نماینده رسمی جفران ایتالیا در ایران

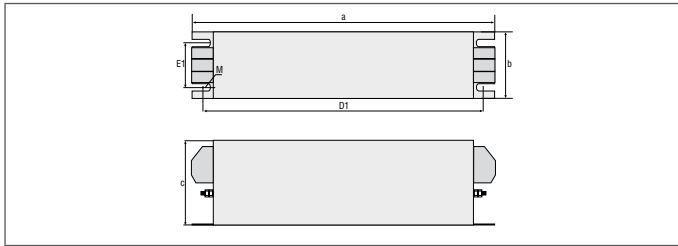

(Book shape) EMI-FTF-480-42 ... 130, EMI 600-34 ... 145 series

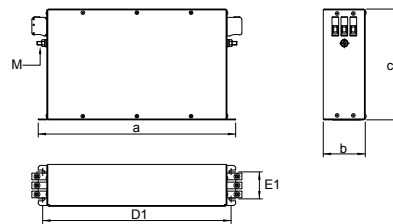

EMI 600-34 ... 145 series

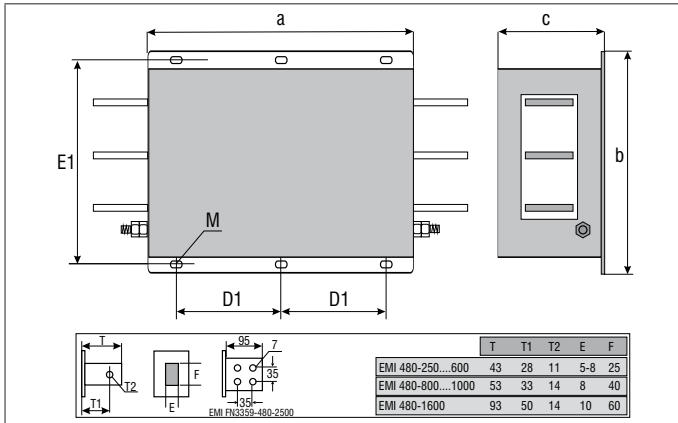

EMI 480-250 ... 1600, EMI-FN3359-...-2500 and EMI-690-320...1600 series

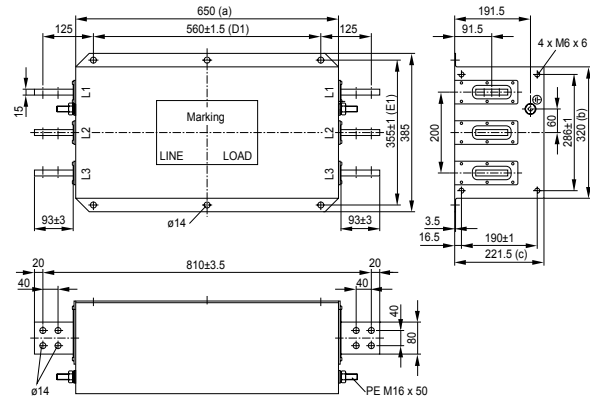

B84143B2500S02.

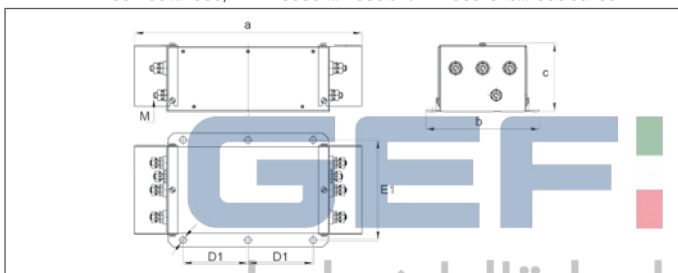

EMI-SCHF-600-205

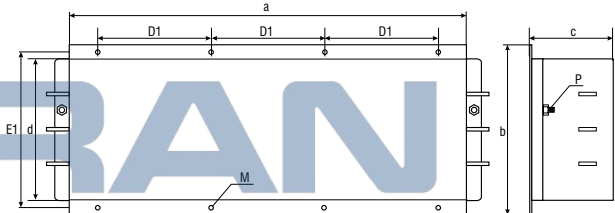

EMI 520-1200

Filter type	Code	Dimensions mm [inches]									Weight kg [lbs]
		a	b	c	d	D1	E1	R	P	M	
EMI 480-320	S7DGH	300 [11.8]	260 [10.2]	135 [5.31]	-	120 [4.72]	235 [9.25]	-	-	M10	13.2 [29.1]
EMI 480-400	S7DGI	300 [11.8]	260 [10.2]	135 [5.31]	-	120 [4.72]	235 [9.25]	-	-	M10	13.2 [29.1]
EMI 480-600	S7DGL	300 [11.8]	260 [10.2]	135 [5.31]	-	120 [4.72]	235 [9.25]	-	-	M10	13.6 [30]
EMI 480-800	S7DGM	350 [13.78]	280 [11.02]	150 [5.91]	-	145 [5.71]	255 [10.04]	-	-	M10	23.7 [52.2]
EMI 480-1000	S7DGN	350 [13.78]	280 [11.02]	150 [5.91]	-	145 [5.71]	255 [10.04]	-	-	M10	24 [52.9]
EMI-600-34	S7DFM	335 [13.2]	60 [2.4]	150 [5.9]	-	320 [12.6]	35 [1.38]	-	-	M5	1.8 [3.9]
EMI-600-62	S7DFO	329 [12.9]	80 [3.2]	125 [4.9]	-	314 [12.4]	55 [2.16]	-	-	M6	3 [6.6]
EMI-600-85	S7DFP	329 [12.9]	80 [3.2]	220 [8.6]	-	314 [12.4]	55 [2.16]	-	-	M6	4.3 [9.5]
EMI-600-113	S7DFQ	379 [14.9]	90 [3.5]	220 [8.6]	-	364 [14.3]	65 [2.6]	-	-	M10	5.6 [12.3]
EMI-600-145	S7DFR	469 [18.5]	110 [4.3]	240 [9.4]	-	414 [16.3]	80 [3.15]	-	-	M10	7.1 [15.6]
EMI-690-320	S7DGR	230 [9]	190 [7.5]	116 [4.5]	-	85 [3.3]	165 [6.5]	-	-	-	7.2 [15.9]
EMI-690-400	S7EMI12	230 [9]	190 [7.5]	116 [4.5]	-	85 [3.3]	165 [6.5]	-	-	-	7.5 [16.5]
EMI-690-600	S7DGS	230 [9]	190 [7.5]	116 [4.5]	-	85 [3.3]	165 [6.5]	-	-	-	7.8 [17.2]
EMI-690-1600	S7D GK	300 [11.8]	260 [10.2]	140 [5.5]	-	120 [4.7]	235 [9.2]	-	-	-	24.5 [54.0]
EMI-FN-3359-480-2500	S7EMI5	450 [17.7]	370 [15.5]	200 [7.9]	-	250 [9.8]	330 [13]	-	-	M16	69 [152.2]
EMI-FTF-480-42	S7GOA	310 [12.2]	50 [2]	85 [3.3]	-	295 [11.6]	30 [1.2]	-	-	M6	1.3 [2.9]
EMI-FTF-480-75	S7GOC	270 [10.6]	80 [3.2]	135 [5.31]	-	255 [10.0]	60 [2.4]	-	-	M6	2.6 [5.7]
EMI-FTF-480-100	S7GOD	270 [10.6]	90 [3.5]	150 [5.9]	-	255 [10.0]	65 [2.6]	-	-	M10	3 [6.6]
EMI-FTF-480-130	S7GOE	270 [10.6]	90 [3.5]	150 [5.9]	-	255 [10.0]	65 [2.6]	-	-	M10	3.6 [9.7]
EMI-SCHF-600-205	S7DGD	420 [16.5]	210 [8.3]	127 [5]	-	120 [4.7]	185 [7.3]	-	-	M10	6.5 [15.9]
TDK-EPCOS B84143B2500S021		650 [25.6]	320 [12.6]	221.5 [8.7]	-	560 [22]	355 [14]	-	-	M16	142 [313.1]
TDK-EPCOS B84143B2500S024		650 [25.6]	320 [12.6]	221.5 [8.7]	-	560 [22]	355 [14]	-	-	M16	142 [313.1]
Schaffner FN 3359HV-2500-99		450 [17.7]	370 [15.5]	200 [7.9]	-	250 [9.8]	330 [13]	-	-	M16	69 [152.2]

Options

Opzioni - Options - Optionen - Opciones

Programming keypad







Code	Type	Description
S5TP02	KB-TPD32-EV	Programming keypad.
S5TP03	KC-TPD32-EV	Diagnostic LED module (standard)
S5TP04	Kit for the mounting of the remote TPD32 keypad	Kit for a remotable setting of keypad (2 meter lenght cable included)

I/O Expansion TBO-32







Code	Type	Description
S5V62	TBO-32	Input / Output expansion

-  Converter standard input / output expansion card:
 - 4 digital inputs (0VDC...+3VDC: 0 ... 0.4mA ; +15VDC...+30VDC: 3 ... 6mA)
 - 4 digital outputs (+15VDC ... +30VDC, max 50mA)
 - 2 analog output (±10V, max 5mA).
-  Scheda di espansione degli ingressi/uscite standard del convertitore:
 - 4 ingressi digitali (0VDC...+3VDC: 0 ... 0.4mA ; +15VDC...+30VDC: 3 ... 6mA)
 - 4 uscite digitali (+15VDC ... +30VDC, max 50mA)
 - 2 uscite analogiche (±10V, max 5mA).
-  Carte d'extension des entrées/sorties standard du convertisseur:
 - 4 entrées digitales (0VDC...+3VDC: 0 ... 0.4mA ; +15VDC...+30VDC: 3 ... 6mA)
 - 4 sorties digitales (+15VDC ... +30VDC, max 50mA)
 - 2 sorties analogiques (±10V, max 5mA).
-  Erweiterungskarte für die Standard-Eingänge/Ausgänge des Stromrichter:
 - 4 Digitaleingänge (0VDC...+3VDC: 0 ... 0.4mA ; +15VDC...+30VDC: 3 ... 6mA)
 - 4 Digitaleausgänge (+15VDC ... +30VDC, max 50mA)
 - 2 Analogausgänge (±10V, max 5mA).
-  Esquema de expansión del convertidor estándar de entrada/salida de corriente:
 - 4 entradas digitales (0VDC...+3VDC: 0 ... 0.4mA ; +15VDC...+30VDC: 3 ... 6mA)
 - 4 salidas digitales (+15VDC ... +30VDC, max 50mA)
 - 2 salidas analógicas (±10V, max 5mA).

Digital encoder interface DEII



Code	Type	Description
S5V10	DEII	9-pole digital encoder interface

-  The DEII option card has been designed to adapt, isolate electrically and connect a digital encoder to the XE1 input on the TPD32 EV converter control cards.
-  La scheda opzionale DEII è stata progettata per adattare, separare galvanicamente e connettere un encoder digitale all'ingresso XE1 delle schede di regolazione dei convertitori TPD32 EV.
-  Les carte optionnelle DEII ont été conçues pour adapter, séparer galvaniquement et connecter un codeur digital à l'entrée XE1 des cartes de régulation des convertisseurs TPD32 EV.
-  Die Optionskarte DEII wurde entwickelt, um digitale Encoder galvanisch getrennt an den Eingang XE1 der Reglerkarte des Stromrichters TPD32 EV anzuschliessen.
-  La tarjeta opcional DEII se ha diseñado para adaptar, separar galvanicamente y conectar un encoder digital a la entrada XE1 de la tarjeta de regulación de los convertidores TPD32 EV.

Application Card APC300

Code	Type	Description
S5W06	APC300	Application card



- MDPLC program based on Standard IEC61131-3
- Integrated Fast Link Communication
- Integrated Master I/O CAN controller

Based on the advanced technology integrated on the APC300 application card, the TPD32 EV converter is capable of meeting the most advanced application requirements associated with state-of-the-art automation systems.

The APC300 card uses MDPLC programming environment based on Standard IEC 61131-3 to create advanced control systems requiring complex control of system variables and high calculation capacity.

You can also increase the number of external I/Os controllable by the TPD32 EV drive (CAN Master function) and interconnect multiple drives with the integrated Fast Link communication to run synchronization processes.

- On request:
- Pre-wired 3-meter CAN cable (Code: S72795)
 - Fast Link communication cable (various lengths)

The experience GEFran has acquired in the major application sectors has also produced an extensive range of specific and/or custom solutions for managing the most complex configurations in machines such as: plants for metal processing, plastics processing, paper, etc...



- Programma MDPLC basato su Standard IEC61131-3
- Fast Link Communication integrata
- Master I/O CAN controller integrato

La tecnologia evoluta utilizzata sulla scheda applicativa APC300, permette al convertitore TPD32 EV di essere integrato con successo nelle più complesse architetture di automazione.

La scheda APC300, utilizzando l'ambiente di programmazione MDPLC basato su standard IEC 61131-3 consente la realizzazione di sistemi di regolazione evoluti, in cui sia necessaria la gestione complessa di variabili di sistema ed un'elevata capacità di calcolo.

E' inoltre possibile incrementare la quantità di I/O esterni gestibili dal drive TPD32 EV (funzionalità CAN Master) e, attraverso la comunicazione Fast Link integrata è possibile connettere più drive tra loro per poter eseguire processi di sincronizzazione.

- A richiesta:
- Cavo CAN pre-cablato con lunghezza di 3m (Codice: S72795)
 - Cavo comunicazione fast Link di diverse lunghezze.

L'esperienza GEFran nei più importanti settori applicativi, mette inoltre a disposizione una vasta gamma di soluzioni specifiche e/o custom, per la gestione delle più sofisticate configurazioni di macchina quali: impianti lavorazione metallo, lavorazione materie plastiche, carta, etc...



- Programme MDPLC basé sur le standard IEC61131-3
- Fast Link Communication intégrée
- Contrôleur E/S CAN maître intégré

La technologie évoluée utilisée sur la carte système APC300 permet au convertisseur TPD32 EV de répondre aux exigences des systèmes modernes d'automatisation les plus divers.

La carte APC300, qui utilise l'environnement de programmation MDPLC basé sur le standard IEC 61131-3, permet de réaliser des systèmes de régulation évolués qui requièrent une gestion complexe des variables de système et une importante capacité de calcul.

Il est en outre possible d'augmenter la quantité d'E/S externes pouvant être gérées par le drive TPD32 EV (fonction CAN Master). Enfin, grâce à la communication Fast Link intégrée, il est possible de connecter plusieurs drives les uns aux autres afin de réaliser des processus de synchronisation.

- En option :
- Câble CAN pré-câblé, 3 m de longueur (Code : S72795)
 - Câble de communication Fast Link de différentes longueurs

L'expérience acquise par GEFran dans les plus importants domaines d'application offre une vaste gamme de solutions spécifiques et/ou personnalisées pour la gestion des configurations de machine les plus complexes: installation d'usinage des métaux, des matières plastiques, du papier, etc...

GEFRAN
نماینده رسمی جفران ایتالیا در ایران



- Auf dem Standard IEC61131-3 basierendes MDPLC-Programm
- Integrierte Fast Link-Kommunikation
- Integrierter Master I/O CAN Controller

Dank der hoch entwickelten Technologie der Anwendungskarte APC300 ist der Stromrichter TPD32 EV in der Lage, den kompliziertesten Anwendungsbedürfnissen moderner Automationssysteme gerecht zu werden.

Die Karte APC300 verwendet die auf Standard IEC 61131-3 basierende MDPLC-Programmierungsumgebung und gestattet die Erstellung fortschrittlicher Steuersysteme, bei denen die komplexe Verwaltung von Systemvariablen und eine hohe Berechnungskapazität erforderlich ist.

Überdies kann die Anzahl der mit dem Antrieb TPD32 EV verwaltbaren externen I/O erhöht werden (CAN Master-Funktion). Über die integrierte Fast Link-Kommunikation ist es möglich, mehrere Antriebe untereinander anzuschließen, damit Synchronisierungsvorgänge ausgeführt werden können.

- Auf Anfrage:
- 3 m langes, vorverkabeltes CAN-Kabel (Code: S72795)
 - Fast Link-Kommunikationskabel in unterschiedlichen Längen.

Dank der Erfahrung auf den wichtigsten Anwendungsgebieten bietet GEF-RAN eine breite Palette spezifischer und/oder kundengerecht gestalteter Lösungen für die Handhabung komplexester Maschinenkonfigurationen: Metallverarbeitungsanlagen, Verarbeitung von Kunststoffmaterialien und Papierverarbeitung usw..



- Programa MDPLC basado en la Norma IEC61131-3
- Comunicación Fast Link integrada
- Controlador Master I/O CAN integrado

La evolucionada tecnología utilizada en la tarjeta de aplicación APC300, permite al TPD32 EV satisfacer las exigencias más sofisticadas de los modernos sistemas de automatización.

La tarjeta APC300, que utiliza el entorno de programación MDPLC basado en la norma IEC 61131-3, permite la realización de sistemas de regulación avanzados, en los cuales es necesario tanto la gestión compleja de las variables del sistema como una elevada capacidad de cálculo.

También puede aumentarse la cantidad de dispositivos de E/S externos gestionados desde la unidad TPD32 EV (funcionalidad CAN Master) y, gracias a la comunicación integrada Fast Link, pueden conectarse varias unidades entre sí para poder realizar los procesos de sincronización.

- Bajo petición:
- Cable CAN precableado con una longitud de 3 metros (Código: S72795)
 - Cable de comunicación Fast Link de diferentes longitudes.

La experiencia GEF-RAN en los más importantes sectores de aplicación, pone además a disposición una amplia gama de soluciones específicas y/o personalizadas, para la gestión de las configuraciones más complejas de máquinas como: equipos de procesamiento de metales, procesamiento de materiales plásticos, papel, etc..

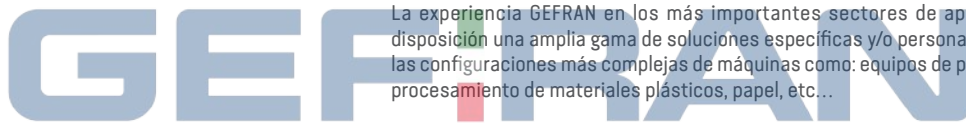

Field Bus Interface

Interfaccia bus di campo - Interface bus de terrain - Feldbus-Schnittstelle - Interfaces de Bus de campo

**Profibus-DP Interface
 SBI-PDP-32**

Code	Type	Description
S5H47	SBI-PDP-32	Field bus interface



- Profibus-DP protocol
- Transmission speed: autoselect from 9,6 kbit/s to 12 Mbit/s
- Bus address: 1...127, selectable via DIP switches
- Data frame: configuration channel towards all the drive parameters; 4 I/O fast word for rapid access
- Sync and Freeze supported.



- Protocollo Profibus-DP
- Velocità di trasmissione: selezione automatica da 9,6 kbit/s a 12Mbit/s
- Indirizzo Bus: 1...127, selezione tramite DIP-switch
- Data frame: canale di configurazione per accedere a tutti i parametri del drive; 4 I/O fast word per accesso veloce
- Supporto Sync e Freeze.



- Protocole Profibus-DP
- Vitesse de transmission : Sélection automatique de 9,6 kbit/s à 12Mbit/s
- Adresse Bus : 1 ... 127, sélection par DIP-switch
- Data frame : canal de configuration pour accéder à tous les paramètres du drive ; 4 E/S fast word pour accès rapide
- Support Sync et Freeze.



- Profibus-DP Protokoll
- Übertragungsgeschwindigkeit: automatische Wahl von 9,6 kbit/s bis 12Mbit/s
- Bus-Adresse: 1...127, Wahl mit DIP-Schalter
- Data frame: Konfigurationskanal für den Zugriff auf alle Antriebsparameter; 4 fast word I/O für raschen Zugriff
- Unterstützt Sync und Freeze.



- Protocolo Profibus-DP
- Velocidad de transmisión: selección automática de 9,6 kbit/s a 12Mbit/s
- Dirección bus: 1 ... 127, selección por medio de conmutadores DIP
- Marco de datos: canal de configuración para acceder a todos los parámetros del drive; 4 E/S fast word para acceso rápido.
- Soporte Sync y Freeze.



DeviceNet Interface
SBI-DN

Code	Type	Description
S5Z28	SBI-DN	Field bus interface



- DeviceNet protocol
- Transmission speed: 125, 250, 500 kbit/s, selectable via DIP switches
- Bus address: 1...63, selectable via DIP switches
- Data frame: Explicit messaging towards all the drive parameters; 1...4 I/O polling word for rapid access, selectable via DIP switch.



- Protocollo DeviceNet
- Velocità di trasmissione: 125, 250, 500 kbit/s, selezione tramite DIP-switch
- Indirizzo Bus: 0...63, selezione tramite DIP-switch
- Data frame: Explicit Messaging per accedere a tutti i parametri del drive; 1...4 Polling I/O word per accesso veloce, selezione tramite DIP-switch.



- Protocole DeviceNet
- Vitesse de transmission : 125, 250, 500 kbit/s, sélection par DIP-switch
- Adresse Bus : 0 ... 63, sélection par DIP-switch
- Data frame : Explicit Messaging pour accéder à tous les paramètres du drive ; 1...4 Polling E/S word pour accès rapide, sélection par DIP-switch.



- DeviceNet Protokoll
- Übertragungsgeschwindigkeit: 125, 250, 500 kbit/s, Wahl mit DIP-Schalter
- Bus-Adresse: 0...63, Wahl mit DIP-Schalter
- Data frame: Explicit Messaging für den Zugriff auf alle Antriebsparameter; 1...4 Polling word I/O für raschen Zugriff, Wahl mit DIP-Schalter.



- Protocollo DeviceNet
- Velocidad de transmisión: 125, 250, 500 kbits/s, selección por medio de conmutadores DIP
- Dirección bus: 0 ... 63, selección por medio de conmutadores DIP
- Marco de datos: Explicit Messaging para acceder a todos los parámetros del drive; 1 ... 4 polling I/O word para acceso rápido, selección por medio de conmutadores DIP

GEFIRAN

CANopen Interface
SBI-COP

Code	Type	Description
S5Z27	SBI-COP	Field bus interface

نماینده رسمی جفران ایتالیا در ایران



- Field bus interface:
- CANopen protocol
- Transmission speed: up to 1 Mbit/s, selectable via DIP switches
- Data frame: 1 SDO towards all the drive parameters, 1 PDO with 4 I/O word for rapid access
- Bus address: 1...128.



- Interfaccia bus di campo:
- Protocollo CANopen
- Velocità di trasmissione: fino a 1 Mbit/s, selezione tramite DIP-switch
- Data frame: 1 SDO per accedere a tutti i parametri del drive, 1 PDO di 4 I/O word per accesso veloce
- Indirizzo Bus: 1...128.



- Interface bus de terrain :
- Protocole CANopen
- Vitesse de transmission : jusqu'à 1 Mbit/s, sélection par DIP-switch
- Data frame : 1 SDO pour accéder à tous les paramètres du drive, 1 PDO de 4 E/O word pour accès rapide
- Adresse Bus : 1 ... 128.



- Feldbus-Schnittstelle:
- CANopen Protokoll
- Übertragungsgeschwindigkeit: bis zu 1 Mbit/s, Wahl mit DIP-Schalter
- Data frame: 1 SDO für den Zugriff auf alle Antriebsparameter, 1 PDO mit 4 word I/O für raschen Zugriff
- Bus-Adresse: 1...128.



- Interfaz bus de campo:
- Protocollo CANopen
- Velocidad de transmisión: hasta 1 Mbit/s, selección por medio de conmutadores DIP
- Marco de datos: 1 SDO para acceder a todos los parámetros del drive; 1 PDO de 4 I/O word para acceso rápido
- Dirección bus: 1 ... 128.

Accessories

Accessori - Accessoires - Zubehörteile - Accesorios



Code	Type	Description
S560T	PCI COM	RS232/RS485 Universal serial interface
8S864C	Shielded cable for PCI 485	RS-485 serial interface cable (L = 4.5 m)
8S874C	Shielded cable for PCI 485	RS-485 serial interface cable (L = 10 m)
S50T6	Kit RS485 - PCI COM	PCI COM + connection cable
S5Z40	A-RS485	External supply for RS485 serial interface
8S8F64	USB-RS485 Converter	USB - RS485 Serial Line Converter



Collegamento via linea seriale. Dispositivi per collegamento tramite linea seriale RS485/RS232.



Connexion par liaison série. Dispositifs pour connexion par liaison série RS485/RS232.



Anschluss mittels serieller Schnittstelle. Stecker für den Anschluss der seriellen Schnittstelle RS485/RS232.



Conexión de la línea de serie opto-acoplada. Equipo para conectar a través de una línea de serie opto-acoplada RS485/RS232.

Accessories for external Power Bridge

Accessori per Ponti di potenza esterni - Accessoires pour Ponts de puissance externes
Zubehör für externe Leistungsbrücken - Accesorios para puentes de potencia externos

Pulse transformer	Code	Rated working voltage [Vrms]	Imax secondary winding		Transformation ratio (P:S:S)
			[A]	[Arms]	
PTD1	S5C370	500	1,2 Peak	0.75	3 : 1
PTD2	S5C371	500	1,2 Peak	0.5	3 : 1 : 1
PTD1-1	S5C372	750	1,2 Peak	0.75	3 : 1
PTD2-1	S5C373	750	1,2 Peak	0.5	3 : 1 : 1
PTD1-1K	S5C374	1000	1,2 Peak	0.75	3 : 1
PTD2-1K	S5C375	1000	1,2 Peak	0.5	3 : 1 : 1

Current transducers	Code	Power bridge rated current [A]
TAS2-1600A/0,4A	S7H22	1000A ≤ IdN ≤ 1800A
TAS2-2400A/0,5A	S7H23	2000A ≤ IdN ≤ 2700A
TAS3-4000A/0,5A	S7H30	2900A ≤ IdN ≤ 3300A

GEFRAN
نماینده رسمی جفران ایتالیا در ایران

Accessories for connection

Accessori per il collegamento
Accessoires pour le raccordement
Zubehör für den Anschluss
Accesorios para la conexión



Code	Type	Description
S7QAЕ3	M/S cable (3 mt.)	Master / Slave connection optical cable (3 mt.).
S7QAQ8	M/S cable (5 mt.)	Master / Slave connection optical cable (5 mt.).
S5H78	SBI-OFM-32	Master Card
S5H83	SBI-OFS-32	Slave Card



Accessories for connecting the TPD32-EV-CU control unit to the TPD32-EV-FC external exciter and TPD32-EV12 pulses configuration.



Accessori per il collegamento Unità di Controllo TPD32-EV-CU con Eccitatrice esterna TPD32-EV-FC e TPD32-EV12 impulsi.



Zubehör für den Anschluss Steuereinheit TPD32-EV-CU mit externer Erregereinrichtung TPD32-EV-FC und TPD32-EV12 Impulse.

Accesorios para la conexión de la unidad de control TPD32-EV-CU con excitador externo TPD32-EV-FC y TPD32-EV12 impulsos.

Code	Type	Description
------	------	-------------

Connector Interface Cables (supplied standard in TPD32-EV-CU):

S72762	KP	Cable, 5-pin, AWG14, tot. length 2.5 m, sheathing for 1.5 m. Link between mains voltage and armature voltage. KP connector.
--------	----	---

Cavo, 5-poli, AWG14, lungh. tot. 2,5m, guaina per 1,5m. Interconnessione con tensione di rete e tensione di armatura. Connettore KP.

Câble, 5-pôles, AWG14, long. tot. 2,5 m, gaine pour 1,5 m. Interconnexion avec Tension de secteur et tension d'armature. Connecteur KP.

Kabel, 5-polig, AWG14, Ges.länge 2,5 m, Kabelmantel für 1,5 m. Zusammenschaltung mit Netzspannung und Ankerspannung. Steckverbinder KP.

Cable, 5 conductores, AWG14, long. tot. 2,5 m, cubierta para 1,5 m. Interconexión con tensión de red y tensión de armadura. Conector KP.

S72763	KPT31	Cable, 3 twisted pairs, 6-pin, AWG18, tot. length 2.5 m, sheathing for 1.5 m. Link between current sensors (CT) and thermal contact on power bridge(s). KPT31 connector.
--------	-------	--

Cavo formato da 3 coppie twistate, 6-poli, AWG18, lungh. tot. 2,5m, guaina per 1,5m. Interconnessione con sensori di corrente (CT) e contatto termico su ponte(i) di potenza. Connettore KPT31.

Câble constitué de 3 paires twistées, 6-pôles, AWG18, long. tot. 2,5 m, gaine pour 1,5 m. Interconnexion avec capteurs de courant (CT) et contact thermique sur pont (i) de puissance. Connecteur KPT31.

Kabel aus 3 verdrehten Paaren, 6-polig, AWG18, Ges.länge 2,5 m, Kabelmantel für 1,5 m. Zusammenschaltung mit Stromführern (CT) und Thermokontakt auf Leistungsbrücke(n). Steckverbinder KPT31.

Cable formado por 3 pares trenzados, 6 conductores, AWG18, long. tot. 2,5 m, cubierta para 1,5 m. Interconexión con sensores de corriente (CT) y contacto térmico del puente (i) de potencia. Conector KPT31.

S72764	KPT11	Cable, 10-pin, AWG22, tot. length 2.5 m, sheathing for 1.5 m. Link between pulse transformers. KPT11 15-pin D connector.
--------	-------	--

Cavo, 10-poli, AWG22, lungh. tot. 2,5m, guaina per 1,5m. Interconnessione con trasformatori d'impulso. Connettore KPT11 tipo D 15-poli.

Câble, 10-pôles, AWG22, long. tot. 2,5 m, gaine pour 1,5 m. Interconnexion avec transformateurs d'impulsion. Connecteur KPT11 type D 15-pôles.

Kabel, 10-polig, AWG22, Ges.länge 2,5 m, Kabelmantel für 1,5 m. Zusammenschaltung mit Impulstransformatoren. Steckverbinder KPT11 Typ D 15-polig.

Cable, 10 conductores, AWG22, long. tot. 2,5 m, cubierta para 1,5 m. Interconexión con transformadores de impulso. Conector KPT11 tipo D de 15 conductores.

Cable, 10 conductores, AWG22, long. tot. 2,5 m, cubierta para 1,5 m. Interconexión con transformadores de impulso. Conector KPT11 tipo D de 15 conductores.

Connector Adapter Cable (optional for TPD32-EV-CU):

S72760	KP ADP	Cable, 5-pin, AWG14, tot. length 0.3 m with sheathing. The cable is an adapter to allow a new TPD32-EV-CU-... control unit to be connected to replace an earlier version of the TPD32 control unit. For KP connector.
--------	--------	---

Cavo, 5-poli, AWG14, lunghezza tot. 0,3m con guaina. Il cavo è un adattatore per poter connettere una nuova Control Unit TPD32-EV-CU-... in sostituzione di una versione precedente di unità di controllo TPD32. Per connettore KP.

Câble, 5-pôles, AWG14, longueur tot. 0,3 m avec gaine. Le câble est un adaptateur permettant de brancher une nouvelle Control Unit TPD32-EV-CU-... en remplacement d'une version précédente d'unité de contrôle TPD32. Pour connecteur KP.

Kabel, 5-polig, AWG14, Ges.länge 0,3 m mit Kabelmantel. Das Kabel ist ein Adapter für den Anschluss einer neuen Control Unit TPD32-EV-CU-... als Ersatz für eine vorherige TPD32 Steuereinheitsversion. Für Steckverbinder KP.

Cable, 5 conductores, AWG14, long. tot. 0,3m con cubierta. El cable es un adaptador para poder conectar una nueva unidad de control TPD32-EV-CU-... en sustitución de una versión anterior de unidad de control TPD32. Para conector KP.

S72761	KPT11 ADP	Y-cable, 15-pin, AWG22, tot. length 0.3 m with sheathing. The cable is an adapter to allow a new TPD32-EV-CU-... control unit to be connected to replace an earlier version of the TPD32 control unit. Connector KPT11 and KPT31 on the TPD32-EV-CU-... side, KPT11 on the TPD32 side,
--------	-----------	--

Cavo "a Y", 15-poli, AWG22, lunghezza tot. 0,3m con guaina. Il cavo è un adattatore per poter connettere una nuova Control Unit TPD32-EV-CU-... in sostituzione di una versione precedente di unità di controllo TPD32. Connettore KPT11 e KPT31 lato TPD32-EV-CU-..., KPT11 lato TPD32.

Câble "en Y", 15-pôles, AWG22, longueur tot. 0,3 m avec gaine. Le câble est un adaptateur permettant de brancher une nouvelle Control Unit TPD32-EV-CU-... en remplacement d'une version précédente d'unité de contrôle TPD32. Connecteur KPT11 et KPT31 côté TPD32-EV-CU-..., KPT11 côté TPD32.

Kabel in "Y-Form", 15-polig, Ges.länge 0,3 m mit Kabelmantel. Das Kabel ist ein Adapter für den Anschluss einer neuen Control Unit TPD32-EV-CU-... als Ersatz für eine vorherige TPD32 Steuereinheitsversion. Steckverbinder KPT11 und KPT31 Seite TPD32-EV-CU-..., KPT11 Seite TPD32.

Cable "a Y", 15 conductores, AWG22, long. tot. 0,3 m con cubierta. El cable es un adaptador para poder conectar una nueva unidad de control TPD32-EV-CU-... en sustitución de una versión anterior de unidad de control TPD32. Conectores KPT11 y KPT31 parte TPD32-EV-CU-..., KPT11 parte TPD32.

GEFIRAN
نماینده رسمی جفران ایتالیا در ایران

Fuse holder

Portafusibili - Porte fusibles - Sicherungshalter - Portafusibles

S7B77

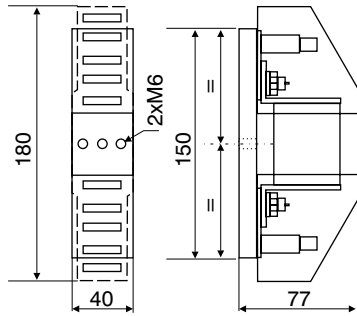

Code	Type	Description
S7B77	Fuse holder 80 mm	For S00... fuses (*), fixing point 80 mm Per fusibili a vite S00... (*), interasse 80 mm Fusible à visser S00... (*), écartement 80 mm Schraubsicherungen S00... (*), Achsabstand 80 mm Fusible de tornillo S00... (*), intereje 80 mm

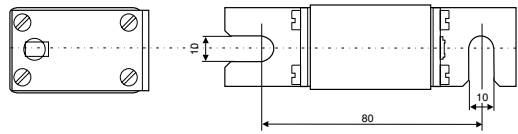

S00... Fuses

S7B78

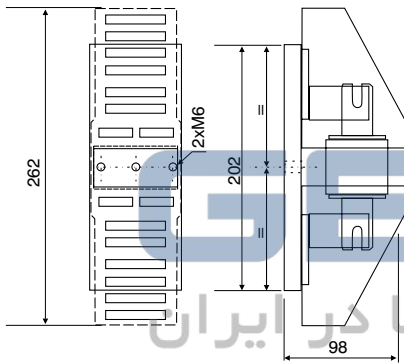

S7B78 Fuse holder 110 mm For S1... - S2... fuses (*), fixing point 110 mm

Per fusibili a vite S1... - S2... (*), interasse 110 mm
 Fusible à visser S1... - S2... (*), écartement 110 mm
 Schraubsicherungen S1... - S2... (*), Achsabstand 110 mm
 Fusible de tornillo S1... - S2... (*), intereje 110 mm

(*) Fuse manufacturer: Jean Müller, Eltville

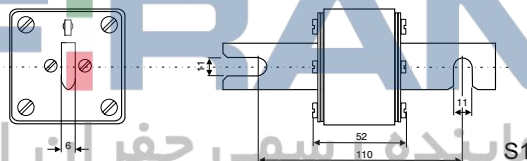

S1... - S2... Fuses

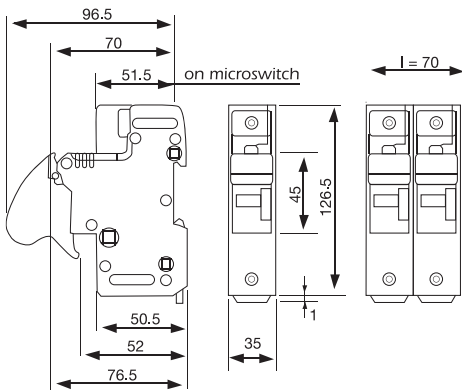

S85B9 FUSE-HOLDER-DC58x2 125A 690V For FU1, FV1 fuses (22x58 mm cylindrical)

Per fusibili FU1, FV1, cilindrico 22x58 mm
 Fusible FU1, FV1, cylindrique 22x58 mm
 Sicherungen FU1, FV1, zylindrisch 22x58 mm
 Fusible FU1, FV1, cilindrico 22x58 mm

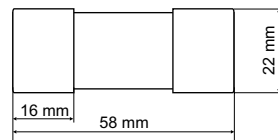

• Una azienda di qualità certificata ISO 9001:2008

La soddisfazione del cliente è il primo degli obiettivi Gefran: da qui nasce la reciproca collaborazione, la massima fiducia nell'azienda e il ruolo di partnership consolidata nel tempo.

Attraverso i propri Servizi Tecnici, Gefran garantisce un supporto globale, (dalla progettazione alla messa in funzione, fino all'assistenza in esercizio), molto più specializzato di quello che le grandi società multisettoriali sono in grado di offrire.

Alla domanda di un'utenza evoluta, Gefran risponde sempre con la certezza della qualità totale.

Saremo lieti di ricevere all'indirizzo e-mail: techdoc@gefran.com qualsiasi informazione che possa aiutarci a migliorare questo catalogo.

La GEF-RAN si riserva la facoltà di apportare modifiche e varianti a prodotti, dati, dimensioni, in qualsiasi momento senza obbligo di preavviso.

I dati indicati servono unicamente alla descrizione dei prodotti e non devono essere intesi come proprietà assicurate nel senso legale.

Tutti i diritti riservati.

• A ISO 9001:2008 certified quality company

Customer satisfaction is Gefran's primary aim: it is from this that mutual collaboration, maximum trust in the company and a consolidated long-standing partnership role stem.

Gefran ensures total support through its technical services (from design and start-up right up to onstream assistance), which are more highly specialized than those which large multi-sector companies are able to offer.

Gefran always meets the demands of high tech users with the certainty of total quality.

Any information or suggestions that could help us to improve this catalogue are always welcome. Please send your comments to our e-mail address at techdoc@gefran.com.

GEFRAN has a policy of the continuous improvement of performance and range of our products and therefore the Company re-tains the right to modify products, data and dimensions without notice. Although the data and information contained in this document is as accurate as we can make it, it is intended to be used for product description purposes only and must not be interpreted as being legally declared specifications.

All rights reserved.

• Une entreprise de qualité certifiée ISO 9001:2008

La satisfaction du client est le premier objectif de Gefran: c'est à partir de là qu'est née la collaboration réciproque, la plus grande confiance dans l'entreprise et le rôle de partenaire renforcé dans le temps.

Par ses propres Services Techniques, Gefran, garantit un support global, (de la conception à la mise en service, jusqu'à l'assistance en exercice), beaucoup plus spécialisé que celui que les grandes sociétés multi-sectorielles sont à même d'offrir.

A la demande d'une utilisation évoluée, Gefran répond toujours avec la certitude de la qualité totale.

Nous serons heureux de recevoir à l'adresse: techdoc@gefran.com toute information pouvant nous aider à améliorer ce catalogue.

GEFRAN se réserve le droit d'apporter des modifications et des variations aux produits, données et dimensions, à tout moment et sans préavis.

Les informations fournies servent uniquement à la description des produits et ne peuvent en aucun cas revêtir un aspect contractuel.

Tous les droits sont réservés.

• Ein Qualitätsbetrieb mit ISO 9001:2008-Zertifizierung

Eine uneingeschränkte Kundenzufriedenheit ist das oberste Ziel von Gefran: sie führt zu einer gemeinschaftlichen Zusammenarbeit, absolutem Vertrauen in die Firma und einer im Laufe der Zeit gefestigten partnerschaftlichen Beziehung.

Durch den technischen Service garantiert Gefran umfassende Unterstützung (vom Entwurf über die Inbetriebnahme, bis hin zum Kundendienst), ein Service der kundennäher ist, als der angebotene Service von großen multisektoriellen Firmen.

Gefran bietet auch auf innovative Anfragen die Sicherheit einer umfassenden Qualität.

Wir würden uns freuen, wenn Sie uns Informationen, die zur Verbesserung dieses Katalogs beitragen können, an folgende E-Mail-Adresse schicken würden: techdoc@gefran.com.

GEFRAN behält sich das Recht vor, ohne Verpflichtung zur Vorankündigung an Produkten, Daten und Abmessungen jederzeit Änderungen oder Varianten vorzunehmen.

Die angeführten Daten dienen lediglich der Produktbeschreibung und dürfen nicht als garantierte Eigenschaften im rechtlichen Sinne verstanden werden.

Alle Rechte vorbehalten.

• Una administración de calidad certificada por ISO 9001:2008.

La satisfacción del cliente es el primero de los objetivos de Gefran: de aquí nace la colaboración recíproca, la máxima confianza en la administración y el rol de asociación consolidada con el tiempo.

A través de los propios Servicios Técnicos, Gefran garantiza un soporte global del proyecto, desde la puesta en funcionamiento, hasta la asistencia en el ejercicio, más especializado de lo que las grandes sociedades multisectoriales pueden ofrecer. A la demanda de un servicio cualificado, Gefran responde siempre con la certeza de la calidad total.

Estaremos encantados de recibirles en la dirección de e-mail techdoc@gefran.com para cualquier información que pueda contribuir a mejorar este manual.

GEFRAN se reserva el derecho de realizar modificaciones y variaciones sobre los productos, datos o medidas, en cualquier momento y sin previo aviso.

Los datos indicados están destinados únicamente a la descripción de los productos y no deben ser contemplados como propiedad asegurada en el sentido legal.

Todos los derechos reservados.

GEFRAN

نماینده رسمی جفران ایتالیا در ایران



FM 608910

Gefran S.p.A. operates a Quality Management System which complies with the requirements of ISO 9001:2008



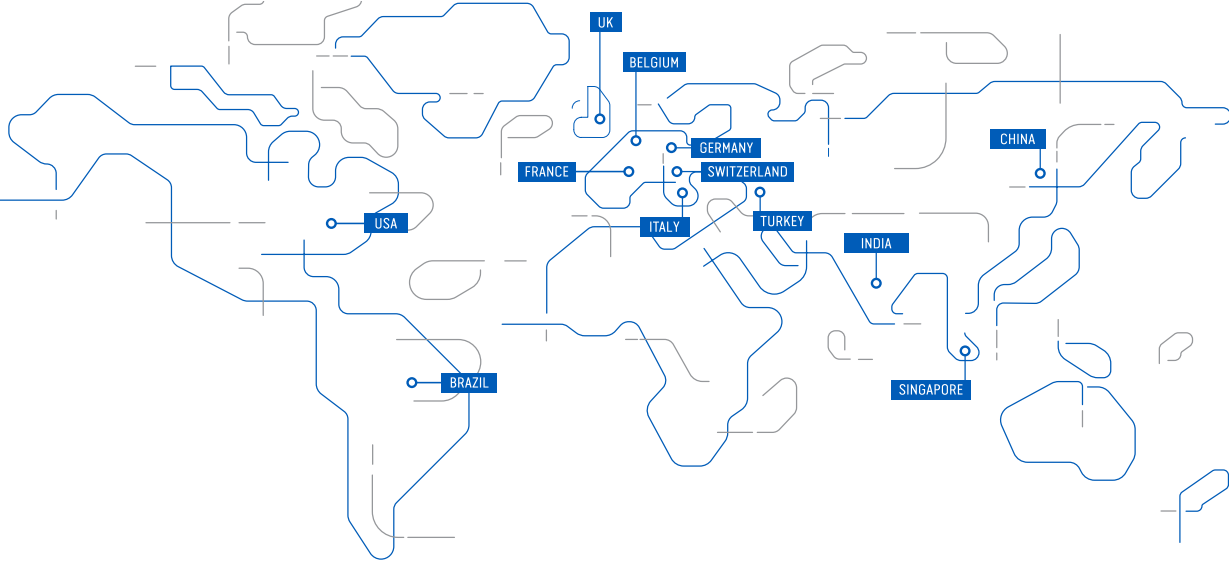

GEFRAN DEUTSCHLAND GmbH

Philipp-Reis-Straße 9a
D-63500
Seligenstadt
Ph. +49 (0) 61828090
Fax +49 (0) 6182809222
vertrieb@gefran.de

GEFRAN BENELUX NV

ENA 23 Zone 3, nr. 3910
Lammerdries-Zuid 14A
B-2250 OLEN
Ph. +32 (0) 14248181
Fax +32 (0) 14248180
info@gefran.be

GEFRAN SIEI - ASIA

31 Ubi Road 1
#02-07,
Aztech Building,
Singapore 408694
Ph. +65 6 8418300
Fax +65 6 7428300
info@gefran.com.sg

GEFRAN HEADQUARTER

Via Sebina, 74
25050 PROVAGLIO D'ISEO (BS) ITALY
Ph. +39 030988881
Fax +39 0309839063

SIEI AREG - GERMANY

Gottlieb-Daimler Strasse 17/3
D-74385
Pleidelsheim
Ph. +49 (0) 7144 897360
Fax +49 (0) 7144 8973697
info@sieiareg.de

GEFRAN UK Ltd

Clarendon Court
Wirwick Quay
Warrington
WA2 8QP
Ph. +44 (0) 8452 604555
Fax +44 (0) 8452 604556
sales@gefran.co.uk

GEFRAN INDIA

Survey No. 191/A/1,
Chinchwad Station Road,
Chinchwad,
Pune - 411033, Maharashtra
Ph. +91 20 6614 6500
Fax +91 20 6614 6501
gefranindia@gefran.in

GEFRAN DRIVES AND MOTION S.R.L.

Via Carducci, 24
21040 GERENZANO (VA) ITALY
Ph. +39 02967601
Fax +39 029682653
info.motion@gefran.com
Technical Assistance:
technohelp@gefran.com
Customer Service
salesmotion@gefran.com

SENSORMATE AG

Steigweg 8,
CH-8355 Aadorf, Switzerland
Ph. +41(0)52-2421818
Fax +41(0)52-3661884
http://www.sensormate.ch

GEFRAN MIDDLE EAST

Yesilköy Mah. Atatürk Cad.
EBS Business Park
No:12 B1 Blok K:12 D:393
Bakırköy/İstanbul/TÜRKİYE
Ph. +90 212 465 91 21
Fax +90 212 465 91 22
info@gefran.com.tr

GEFRAN Inc.

400 Willow Street
North Andover, MA
01845 USA
Toll Free 1-888-888-4474
Fax +1 (617) 340 2761
info.us@gefran.com

GEFRAN FRANCE SA

PARC TECHNOLAND
Bâtiment K - ZI Champ Dolin
3 Allée des Abruzzes
69800 Saint-Priest
Ph. +33 (0) 478770300
Fax +33 (0) 478770320
commercial@gefran.fr

GEFRAN SIEI

Drives Technology Co., Ltd
No. 1285, Beihe Road, Jiading
District, Shanghai,
China 201807
Ph. +86 21 69169898
Fax +86 21 69169333
info@gefran.com.cn

**GEFRAN BRASIL
ELETROELETRÔNICA**

Avenida Dr. Altino Arantes,
377 Vila Clementino
04042-032 SÃO PAULO - SP
Ph. +55 (0) 1155851133
Fax +55 (0) 1132974012
comercial@gefran.com.br



www.gefran.com